

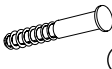









- |     |   |     |     |   |     |      |   |     |      |   |   |      |  |  |      |   |   |      |   |   |     |      |
|-----|---|-----|-----|---|-----|------|---|-----|------|---|---|------|--|--|------|---|---|------|---|---|-----|------|
| x 8 |  | (K) | x 8 |  | (E) | 4x16 |  | (X) | x 16 | 5x9   |  | (N)  | x 12   |  | (M)  | x 16  |  | (A)  | x 38  |  | (G) | x 35 |
| x 2 |  |     | x 4 |  | (Z) | 4x30 |  | (L) | x 8  |  | (F)   | x 24 |  | (B)  | x 24 |  | (C)   | x 24 |  | ( )   | x 1 |      |

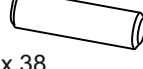

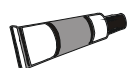
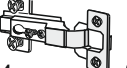
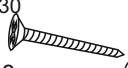
1



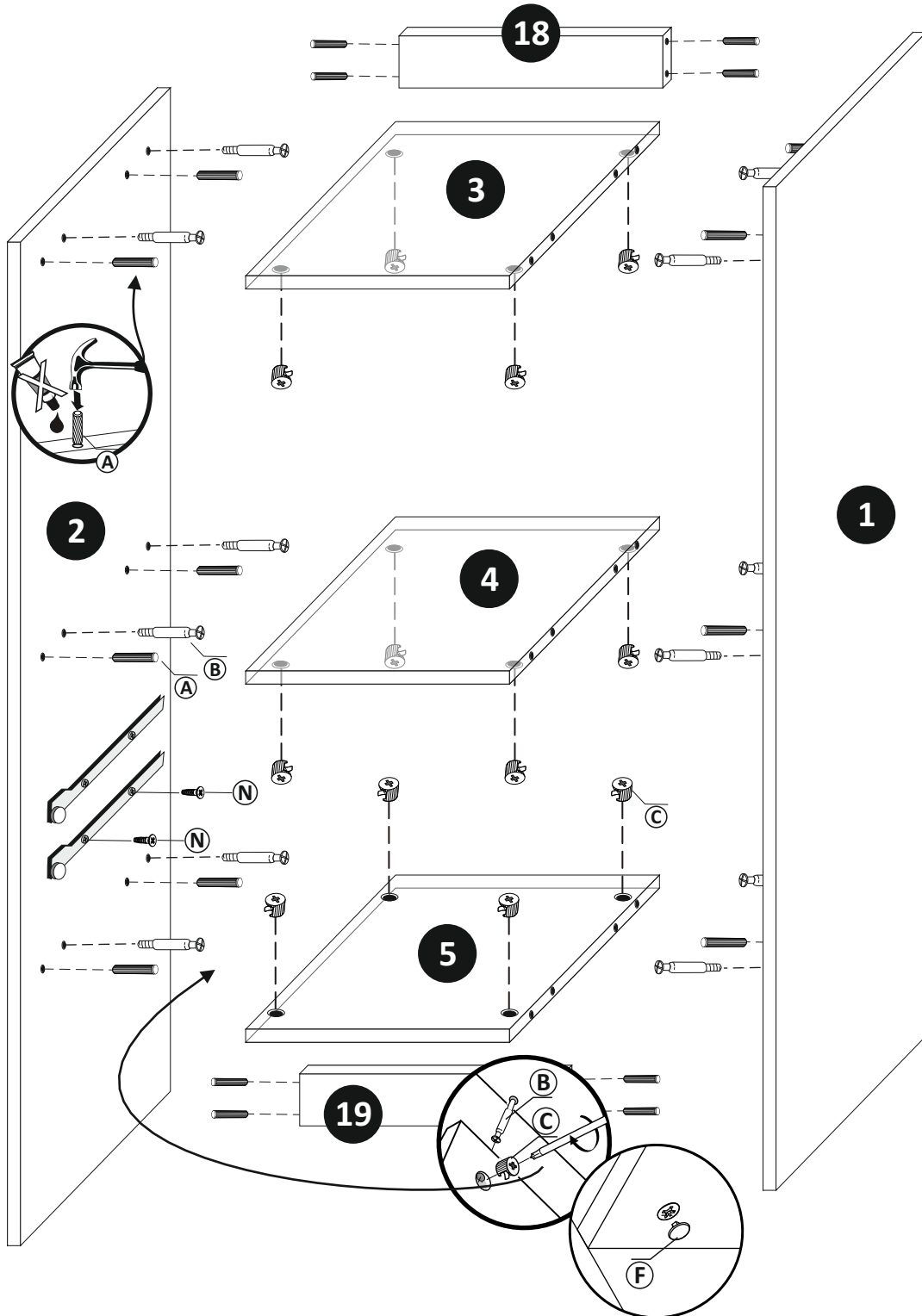
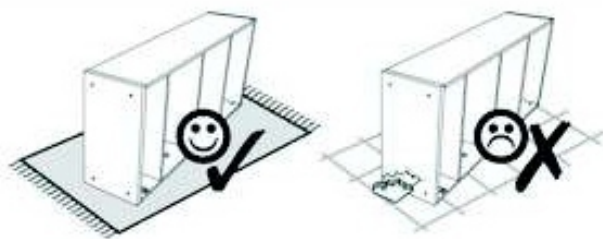

2

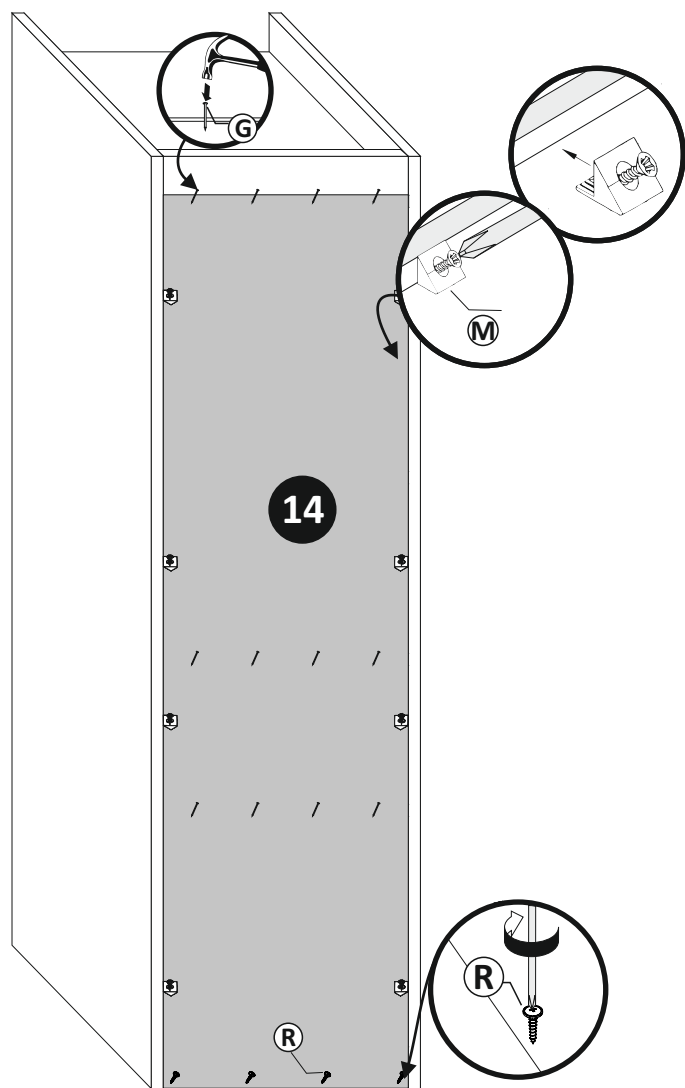

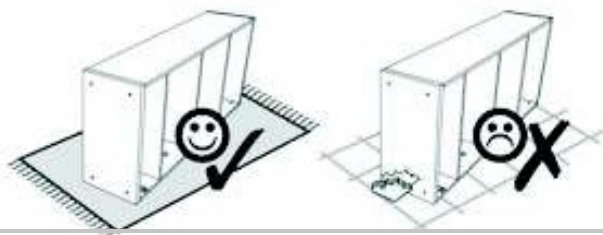

3

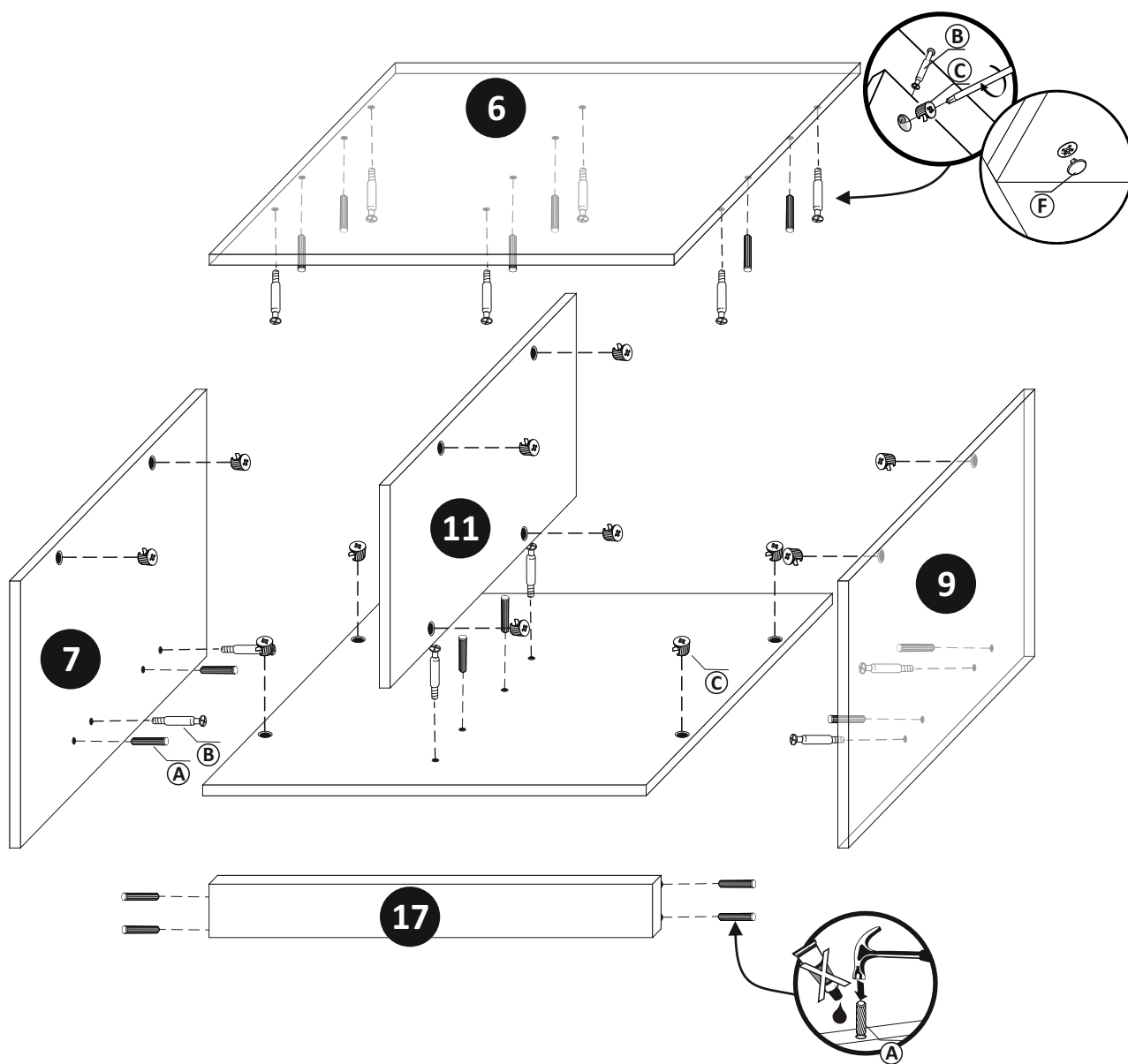

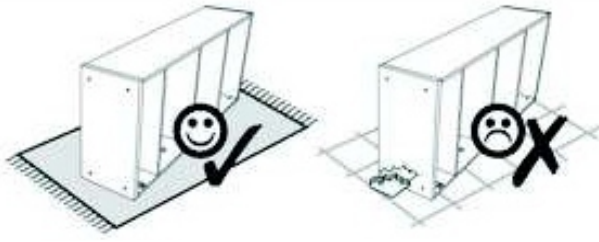

4

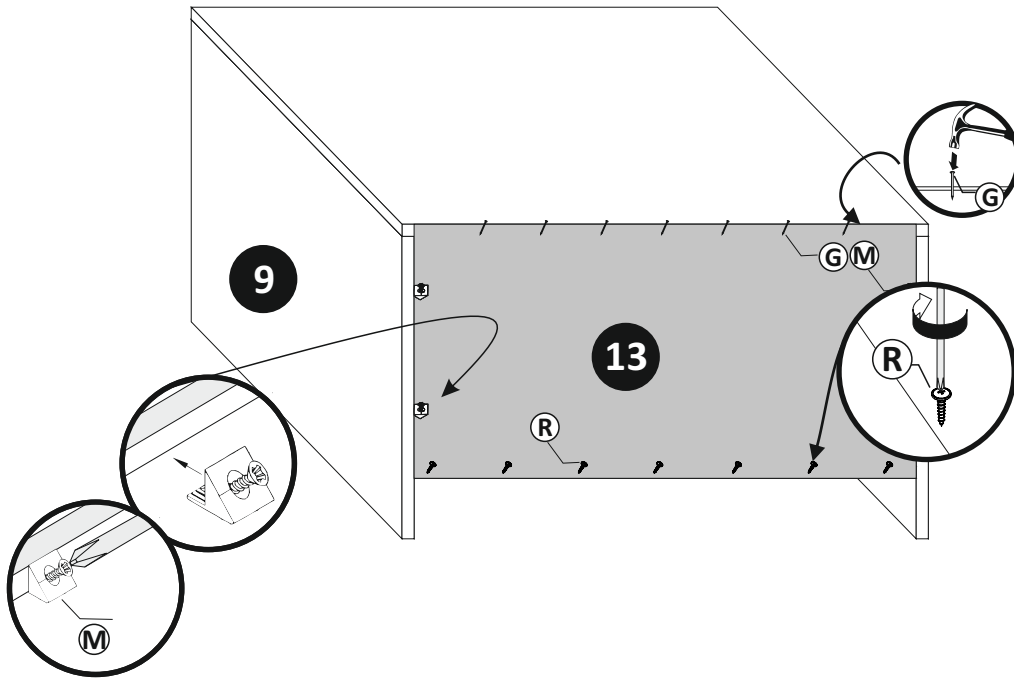

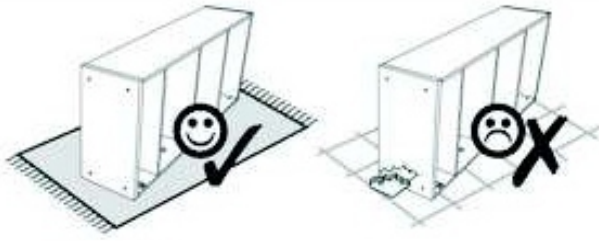

5

