









 A	 B	 C	 D	 4X13 W	 3.5X35 G	 I
8	1	8	8	28	18	1



 H	 S
28	14

1

		3.5X35 
C	I	G
8	1	16

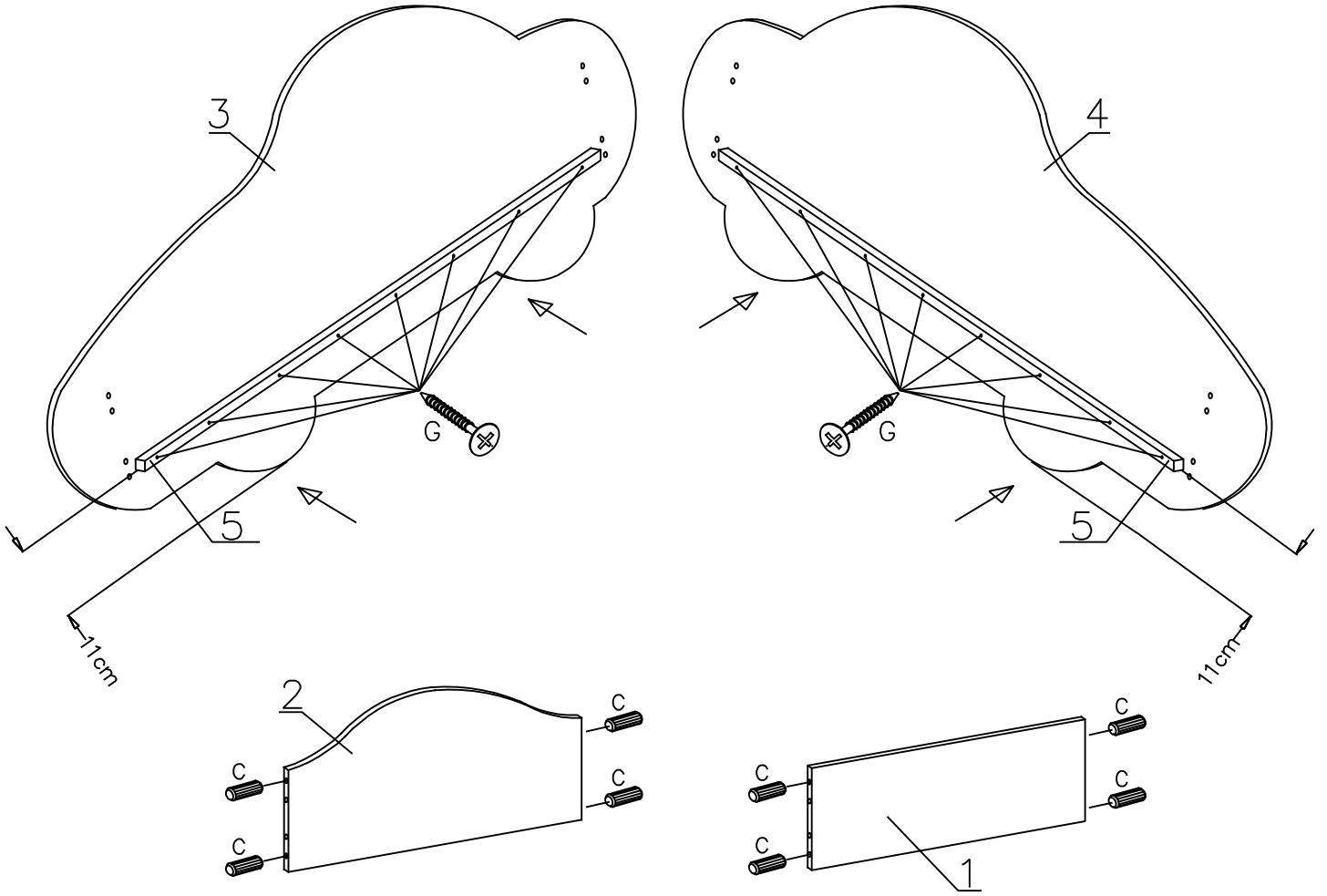

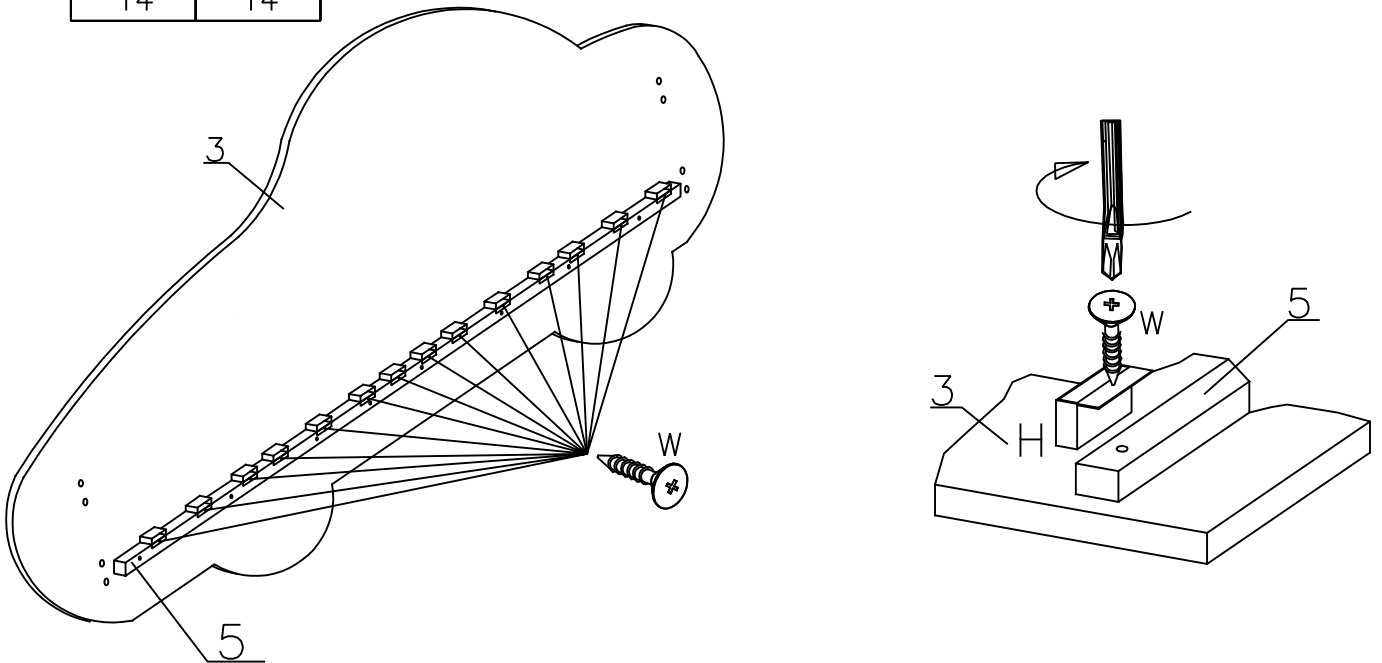

2

	4X13 
H	W
14	14



3

		
A	B	D
8	1	8

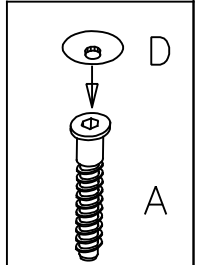
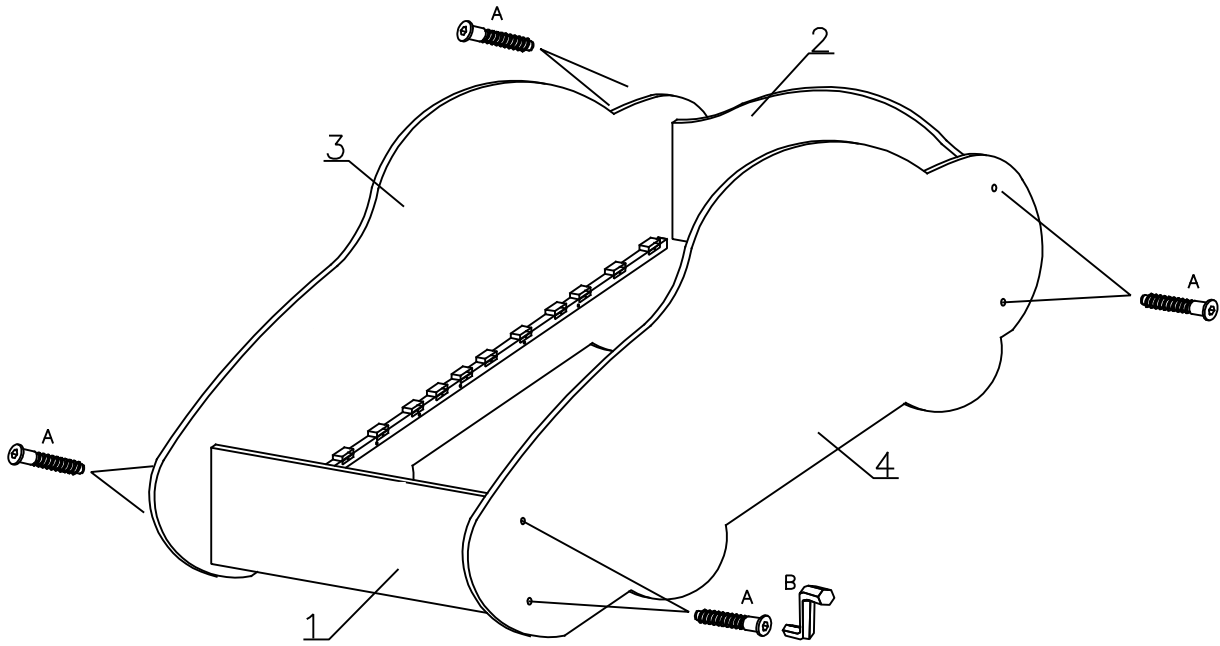

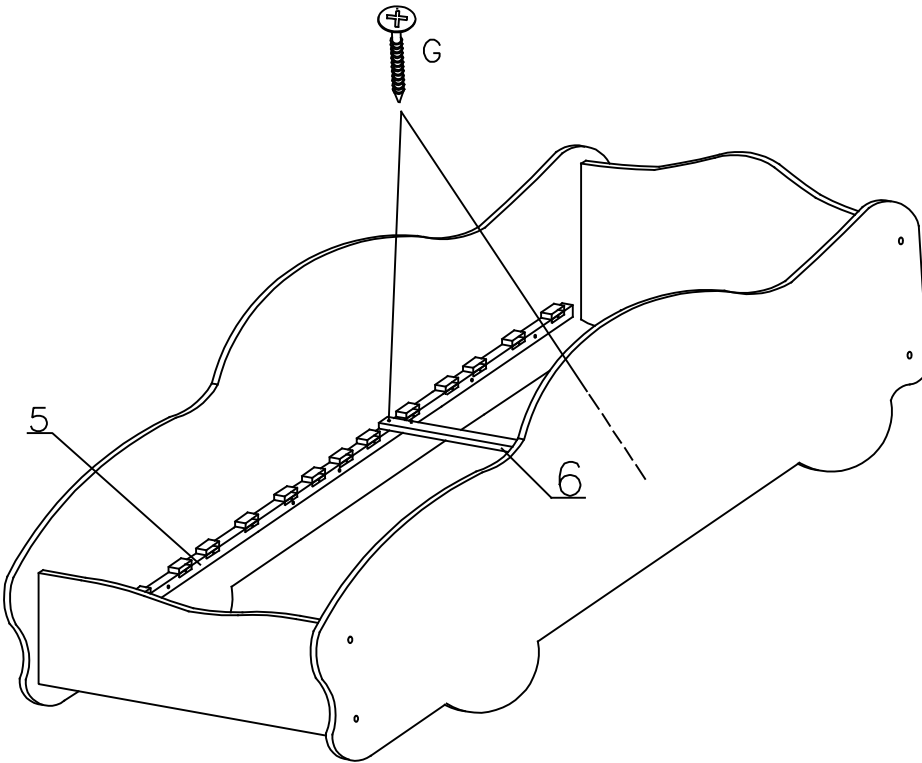

4

3.5X35 	G
2	



5

 H	4X13  W	 S
14	14	14

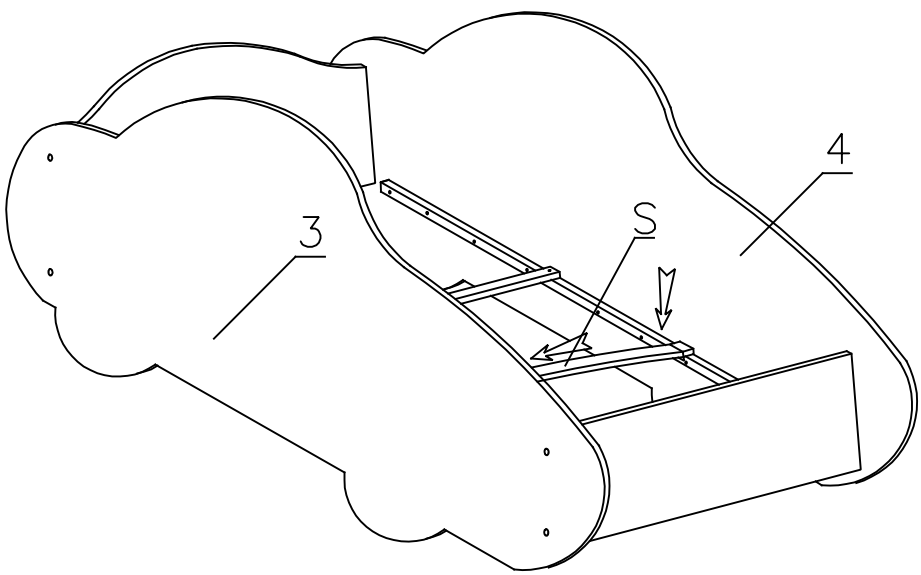
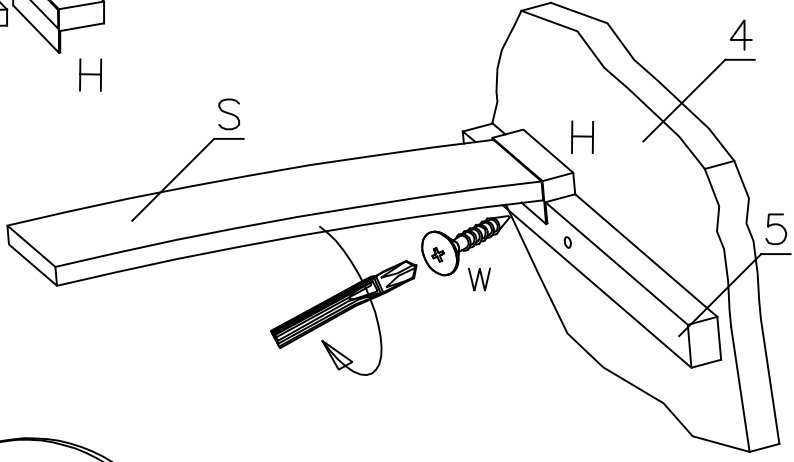
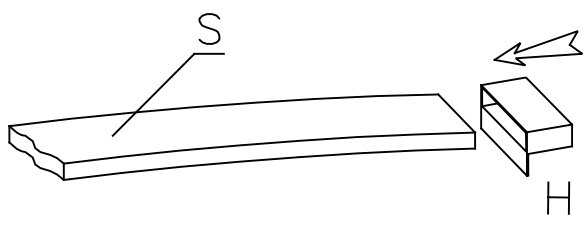

6A

