

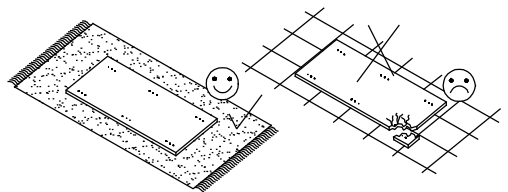

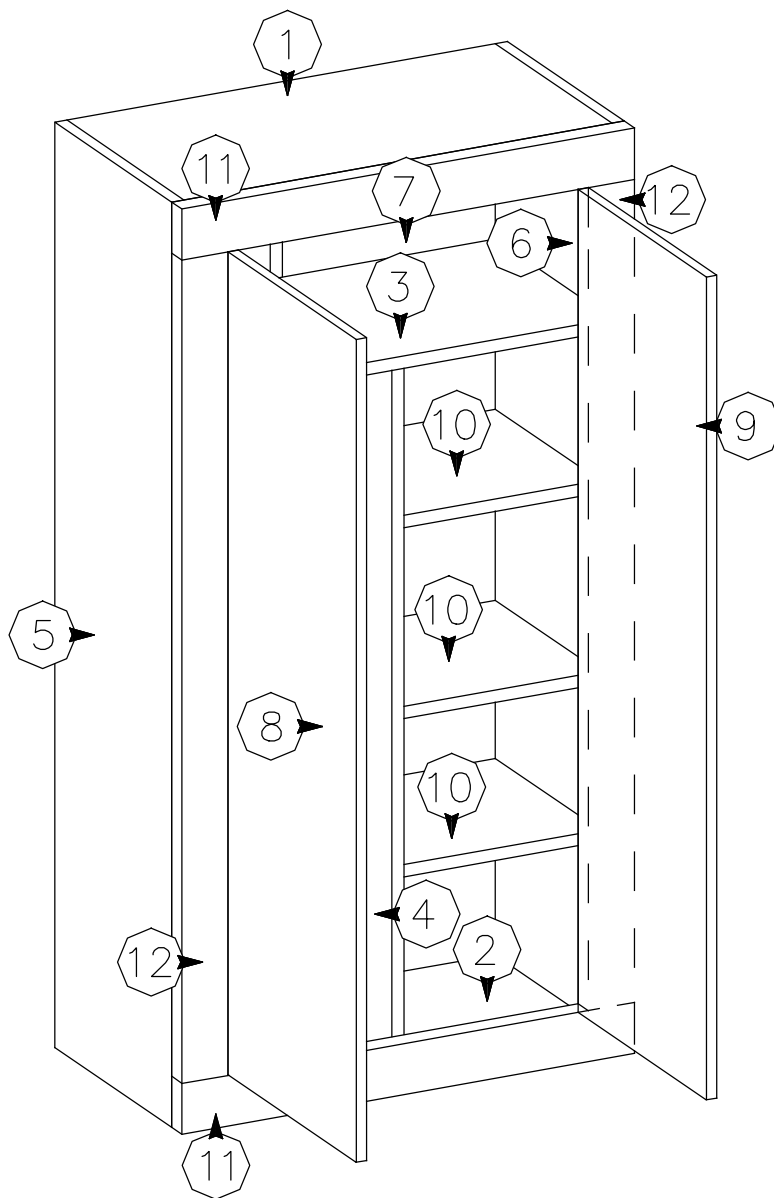















4mm







| | |
|----|---|
| 1 | 1 |
| 2 | 1 |
| 3 | 1 |
| 4 | 1 |
| 5 | 1 |
| 6 | 1 |
| 7 | 1 |
| 8 | 1 |
| 9 | 1 |
| 10 | 3 |
| 11 | 2 |
| 12 | 2 |

| | | | | | | | | |
|---|---|---|---|---|---|--|---|---|
|  |  | 8.0x35  |  | 4.0x27  |  |  |  |  |
| 16 | 1 | 16 | 14 | 4 | 6 | 2 | 6 | 2 |
|  |  |  | 4.0x13  |  |  |  |  |  |
| 1 | 50 | 18 | 14 | 18 | 18 | 12 | 1 | 6 |

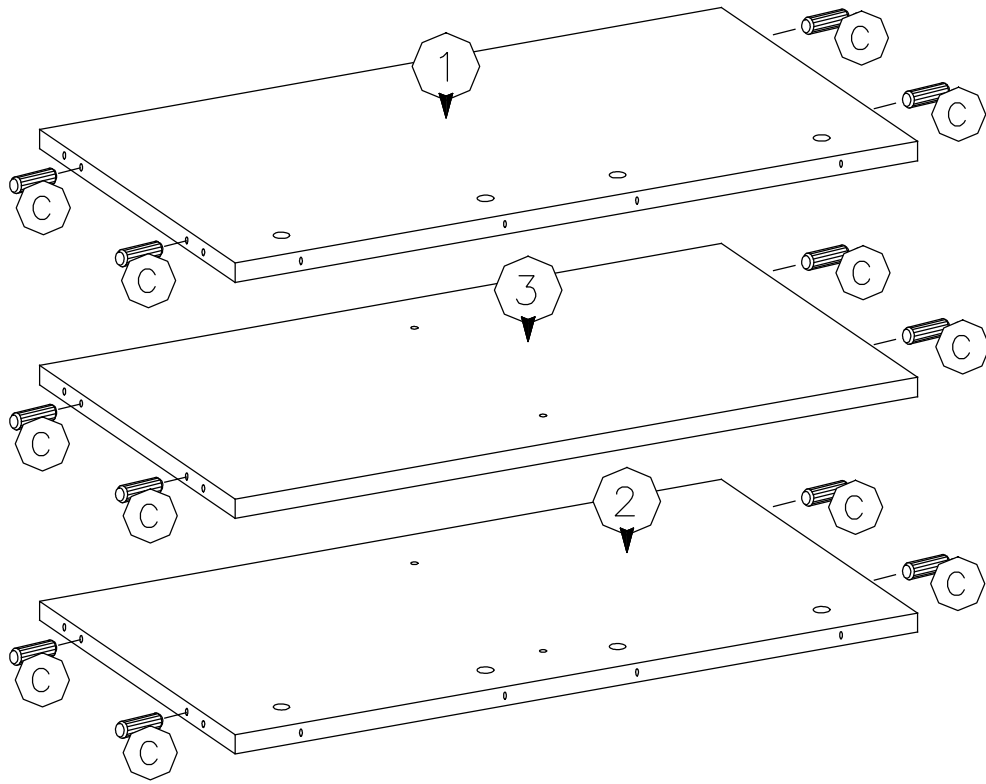
1



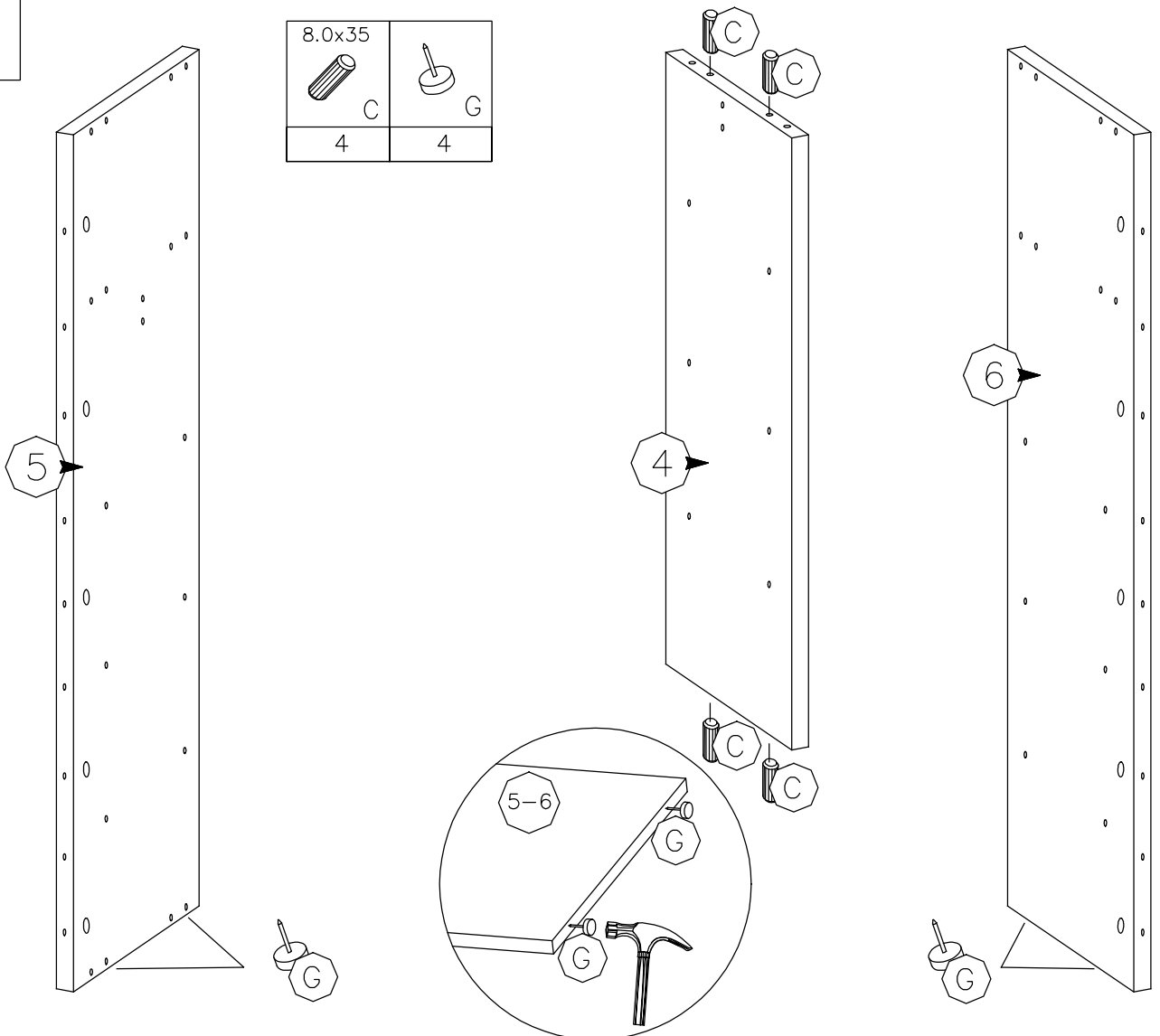

| |
|---|
| 8.0x35 |
|  C |
| 12 |

2



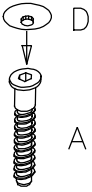
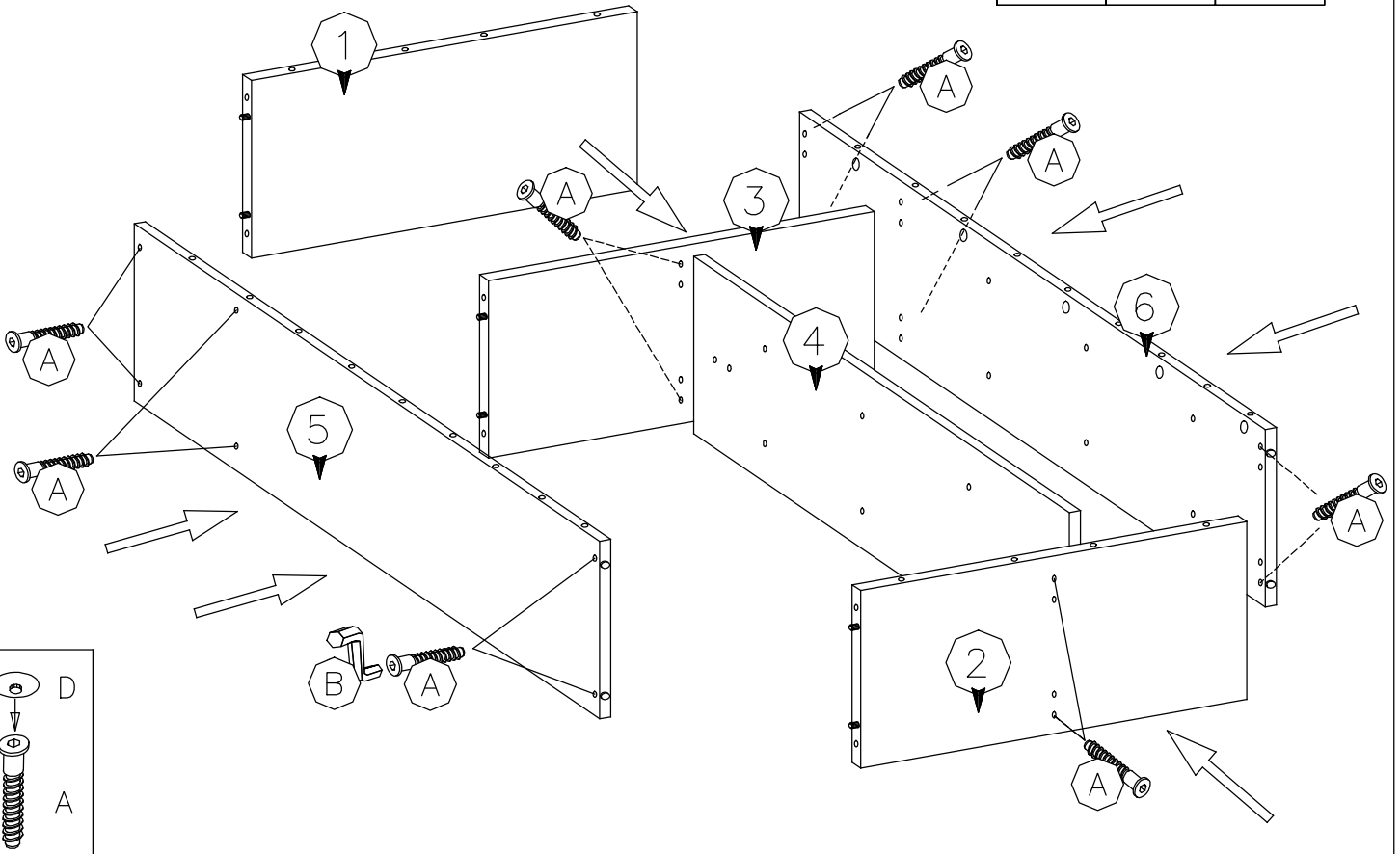

3

| | | |
|---|---|---|
|  |  |  |
| A | B | D |
| 16 | 1 | 14 |





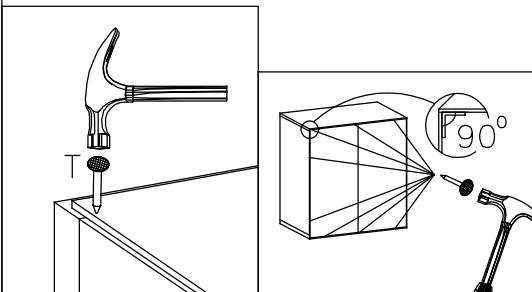
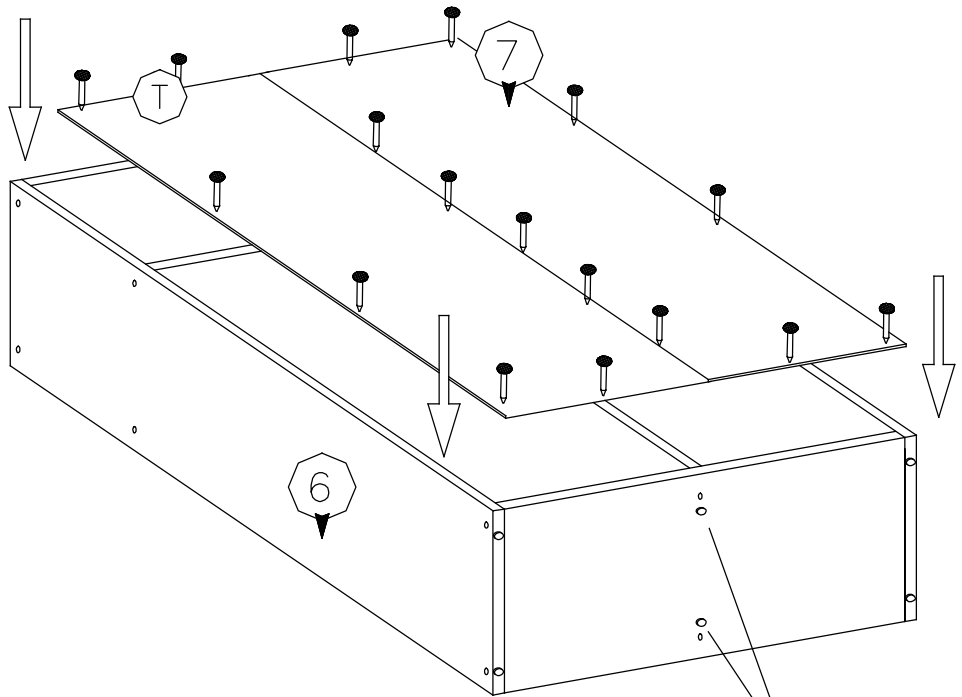

4

| | |
|---|---|
|  |  |
| T | G |
| 50 | 2 |





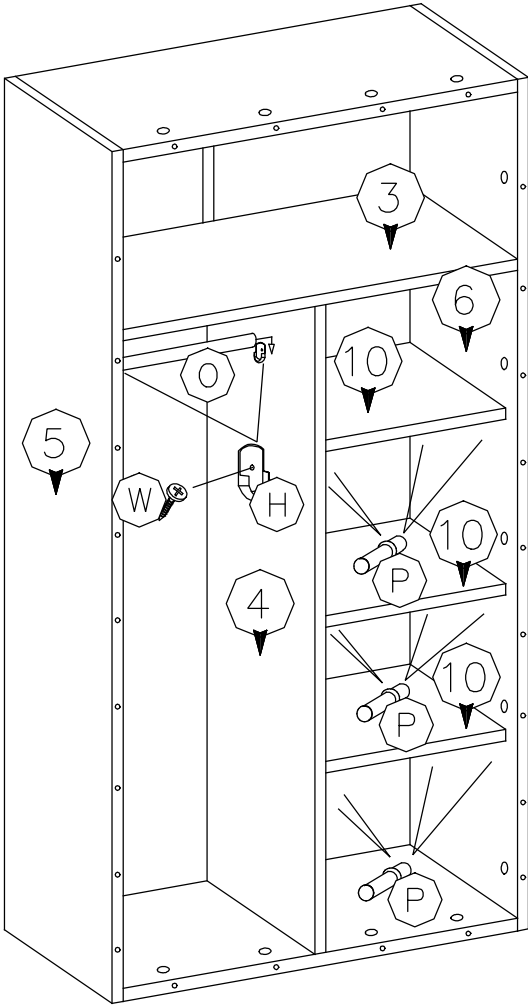

5A

| | | | |
|---|---|--|---|
|  |  |  |  |
| P | O | H | W |
| 12 | 1 | 2 | 2 |

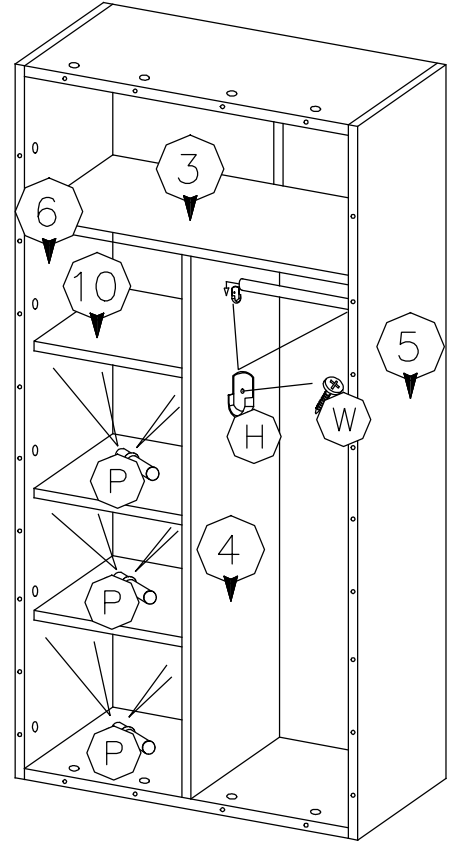





5B

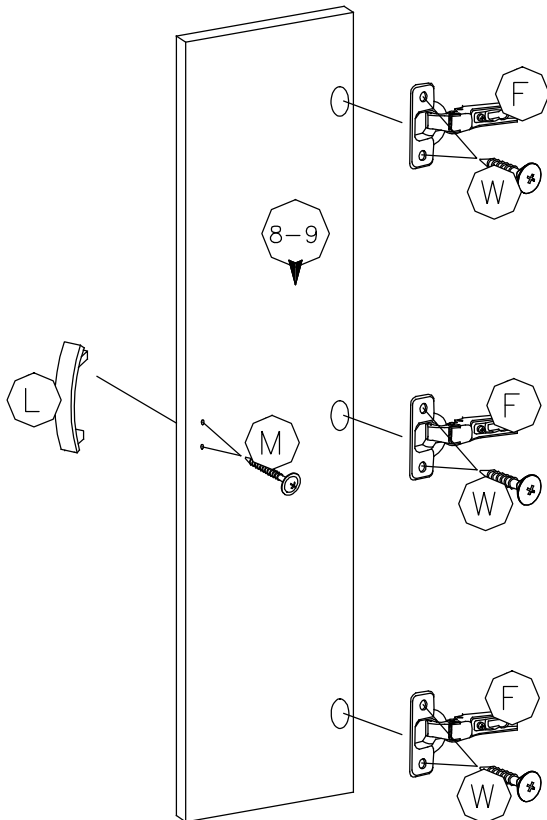

| | | | |
|--|---|---|---|
|  |  |  |  |
| P | O | H | W |
| 12 | 1 | 2 | 2 |

6



| | |
|---|---|
|  |  |
| M | L |
| 4 | 2 |
|  |  |
| W | F |
| 12 | 6 |

7

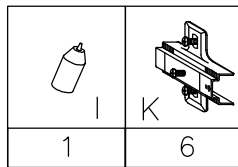
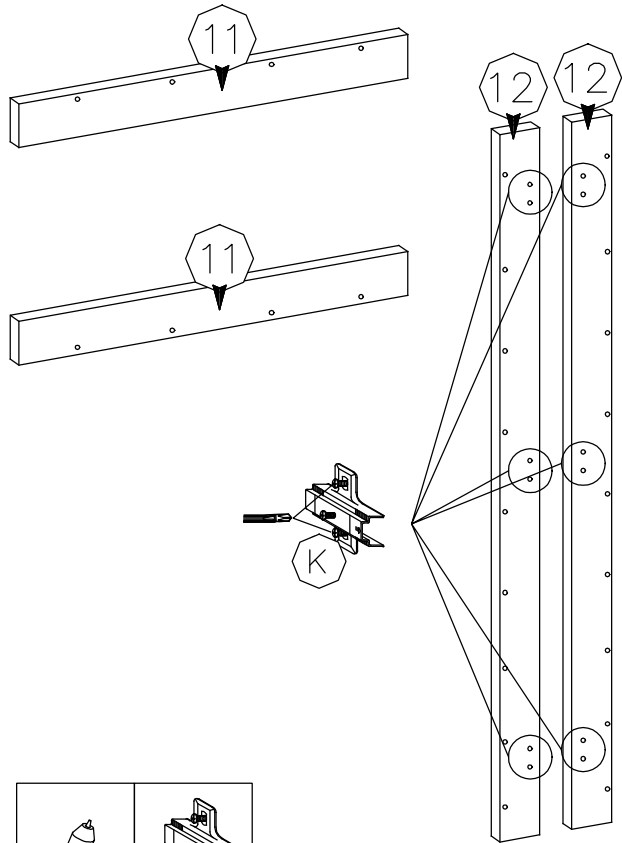
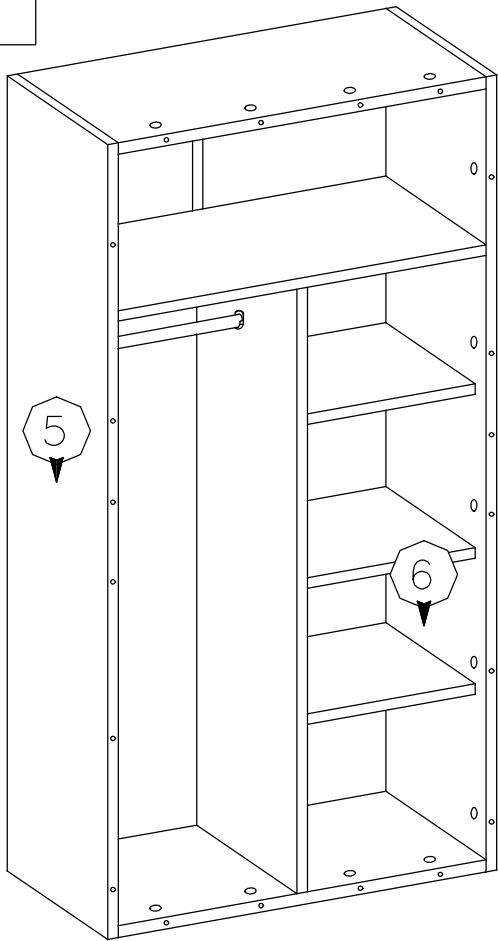

8

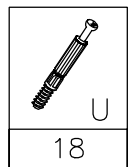
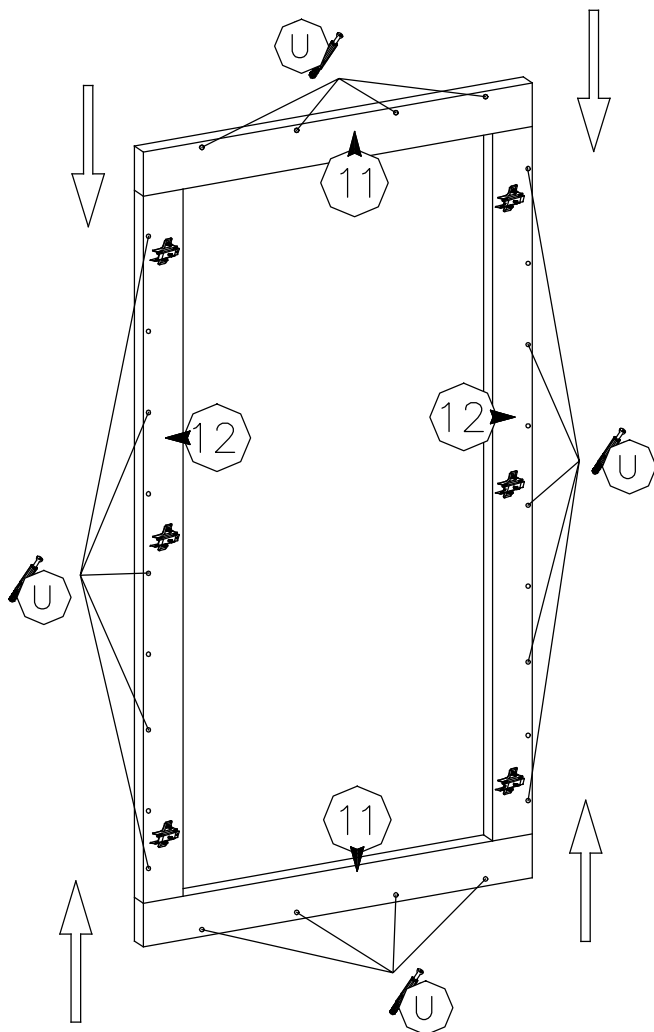

8

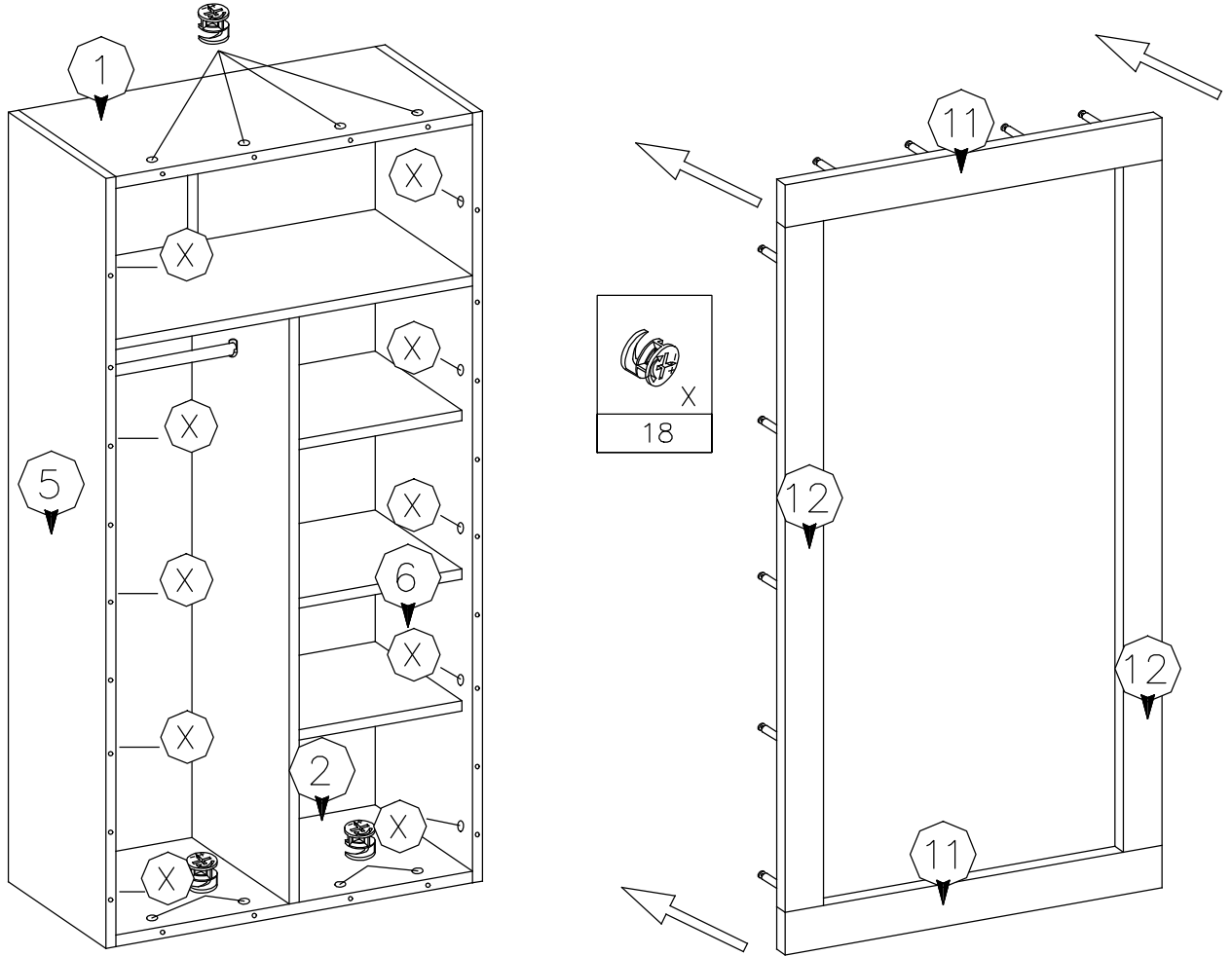

10

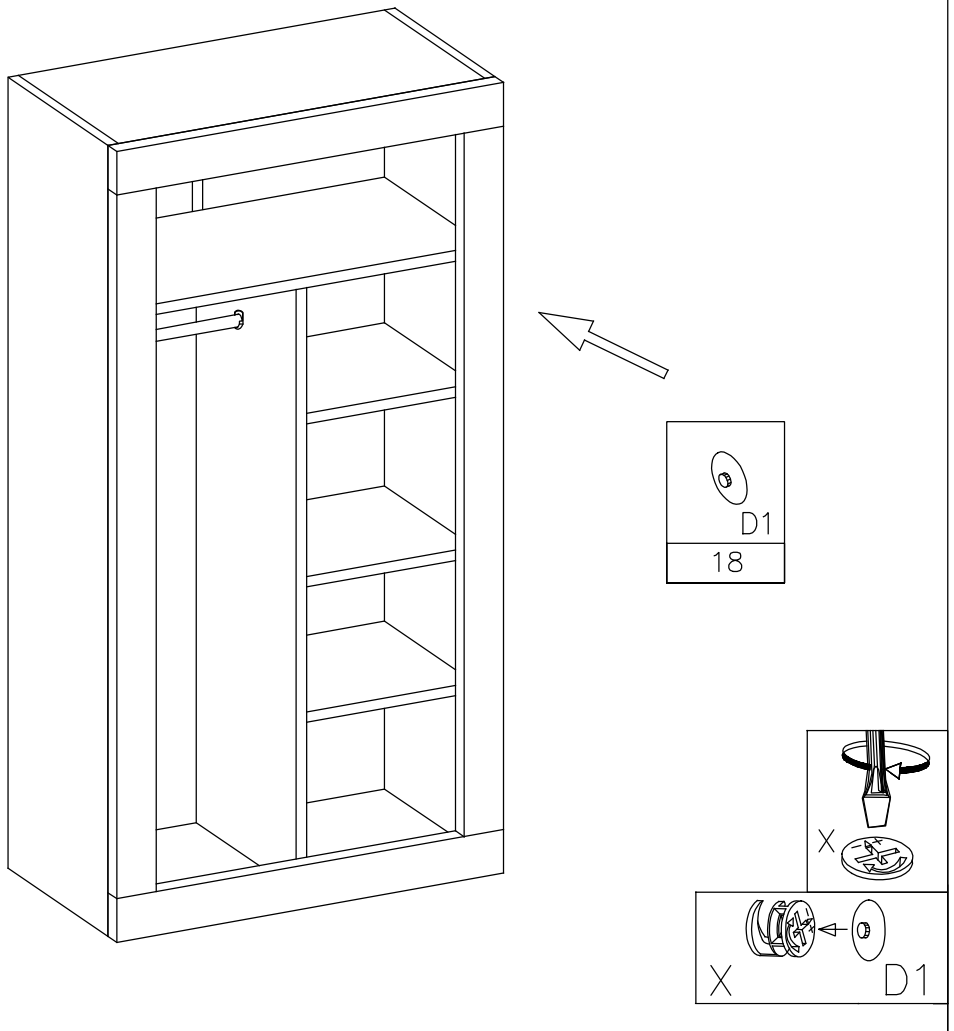

11

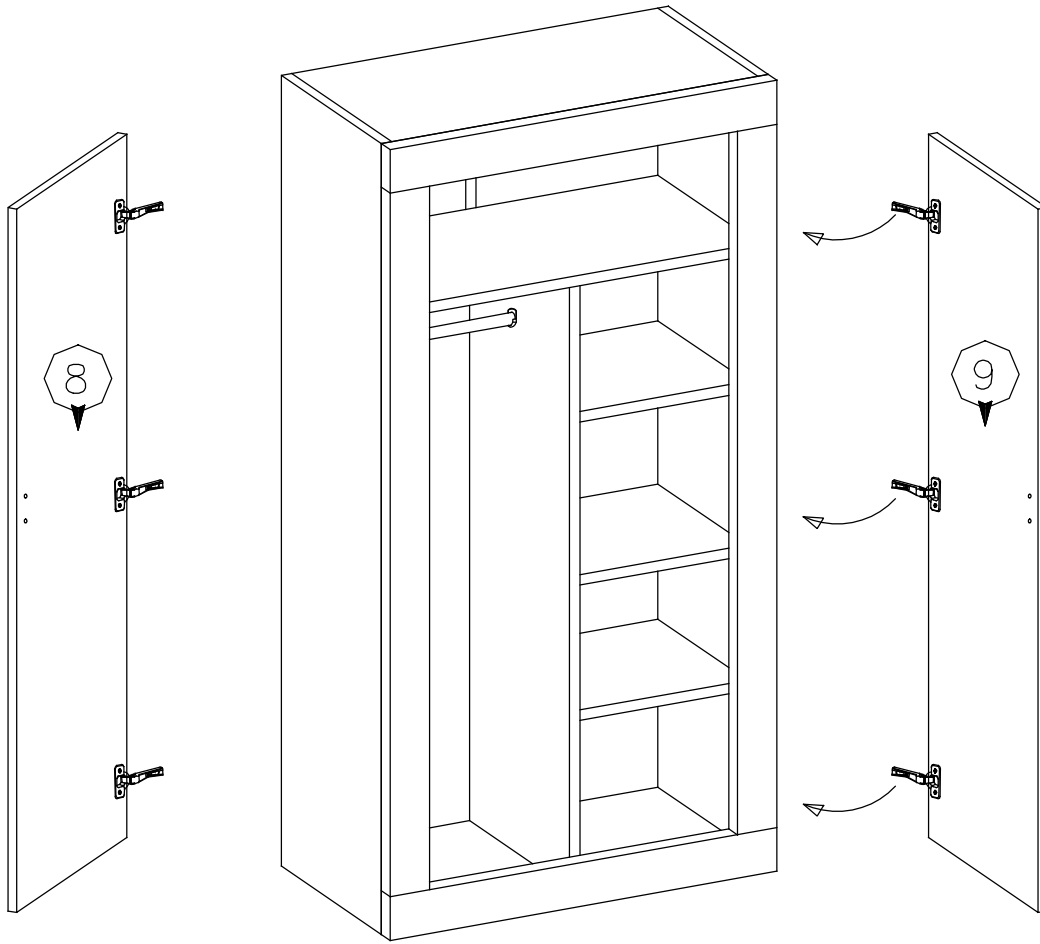

12

