

1

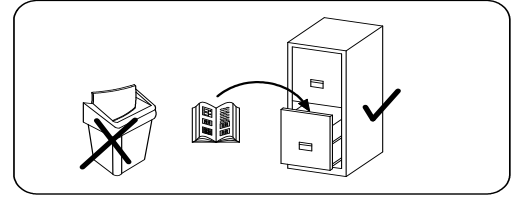

2

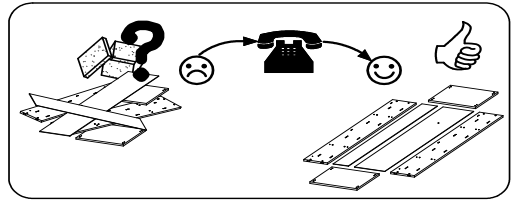
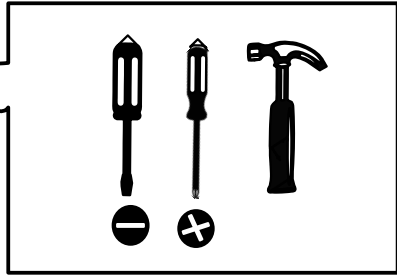
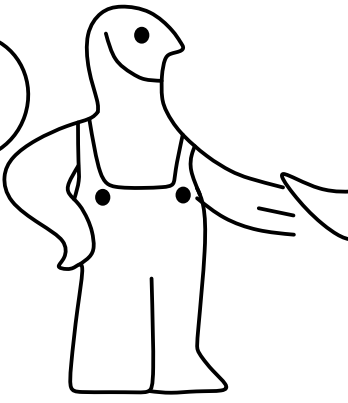
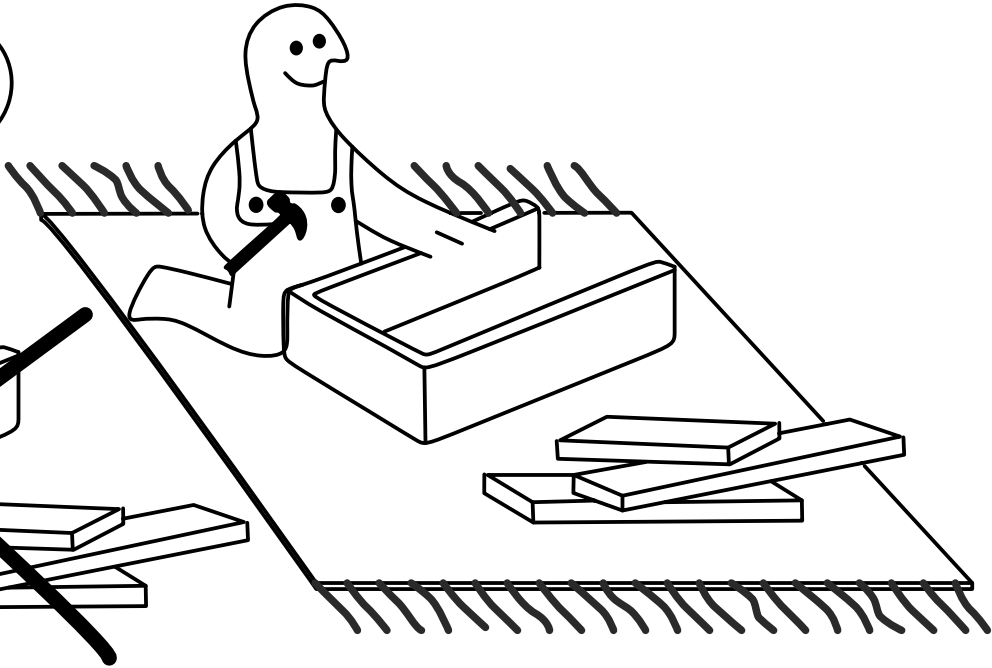
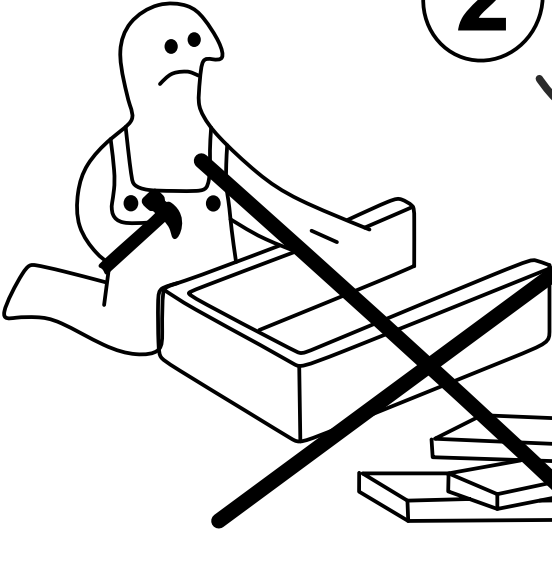

3

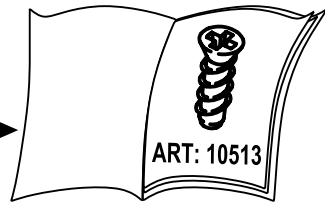

4

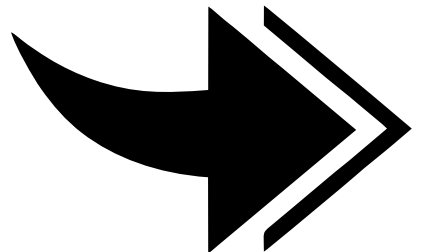
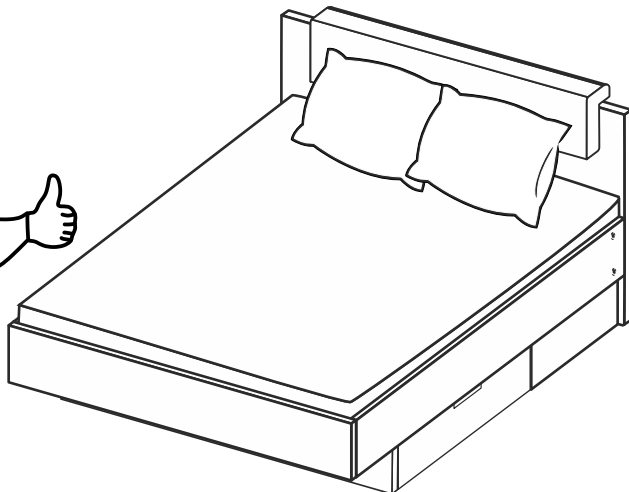

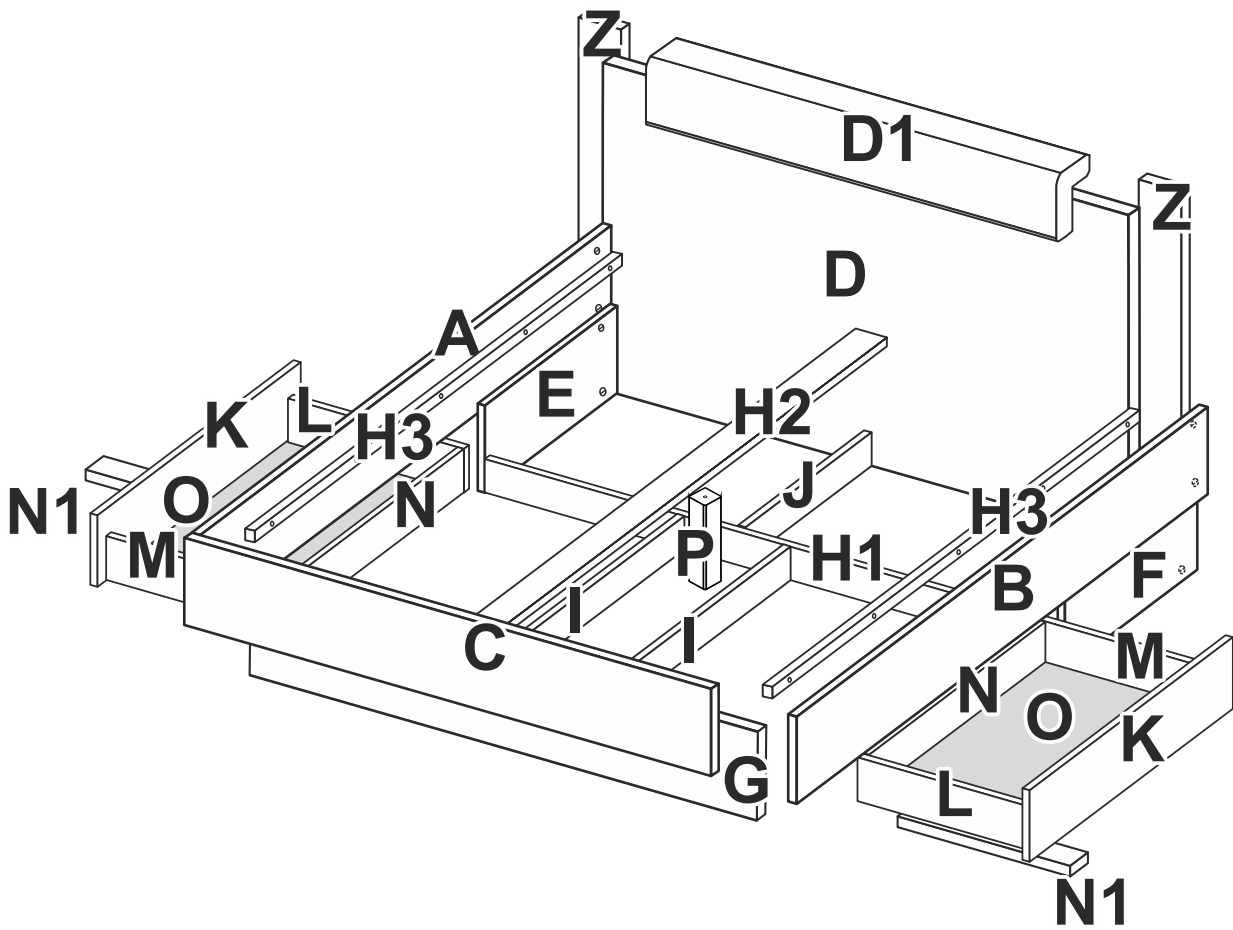

### 1.6 m

<b>A</b>	-	2020	x	230	x	16	-	x	1	3/4
<b>B</b>	-	2020	x	230	x	16	-	x	1	3/4
<b>C</b>	-	1644	x	230	x	16	-	x	1	2/4
<b>D</b>	-	1644	x	900	x	16	-	x	1	2/4
<b>D1</b>	-	1374	x	200	x	95	-	x	1	1/4
<b>E</b>	-	650	x	255	x	16	-	x	1	3/4
<b>F</b>	-	650	x	255	x	16	-	x	1	3/4
<b>G</b>	-	1610	x	270	x	16	-	x	1	2/4
<b>H1</b>	-	1578	x	128	x	16	-	x	1	2/4
<b>H2</b>	-	2007	x	70	x	25	-	x	1	3/4
<b>H3</b>	-	2006	x	30	x	25	-	x	2	3/4
<b>I</b>	-	1119	x	128	x	16	-	x	2	4/4
<b>J</b>	-	634	x	128	x	16	-	x	1	1/4
<b>K</b>	-	1113	x	229	x	16	-	x	2	4/4
<b>L</b>	-	600	x	116	x	16	-	x	2	4/4
<b>M</b>	-	600	x	116	x	16	-	x	2	4/4
<b>N</b>	-	1080	x	136	x	16	-	x	2	4/4
<b>N1</b>	-	584	x	100	x	16	-	x	2	4/4
<b>O</b>	-	596	x	1074	x	3	-	x	2	2/4
<b>P</b>	-	285	x	50	x	50	-	x	1	1/4
<b>Z</b>	-	900	x	120	x	16	-	x	2	1/4

### 1.8 m

<b>A</b>	-	2020	x	230	x	16	-	x	1	3/4
<b>B</b>	-	2020	x	230	x	16	-	x	1	3/4
<b>C</b>	-	1844	x	230	x	16	-	x	1	2/4
<b>D</b>	-	1844	x	900	x	16	-	x	1	2/4
<b>D1</b>	-	1574	x	200	x	95	-	x	1	1/4
<b>E</b>	-	650	x	255	x	16	-	x	1	3/4
<b>F</b>	-	650	x	255	x	16	-	x	1	3/4
<b>G</b>	-	1810	x	270	x	16	-	x	1	2/4
<b>H1</b>	-	1778	x	128	x	16	-	x	1	2/4
<b>H2</b>	-	2007	x	70	x	25	-	x	1	3/4
<b>H3</b>	-	2006	x	30	x	25	-	x	2	3/4
<b>I</b>	-	1119	x	128	x	16	-	x	2	4/4
<b>J</b>	-	634	x	128	x	16	-	x	1	1/4
<b>K</b>	-	1113	x	229	x	16	-	x	2	4/4
<b>L</b>	-	600	x	116	x	16	-	x	2	4/4
<b>M</b>	-	600	x	116	x	16	-	x	2	4/4
<b>N</b>	-	1080	x	136	x	16	-	x	2	4/4
<b>N1</b>	-	584	x	100	x	16	-	x	2	4/4
<b>O</b>	-	596	x	1074	x	3	-	x	2	2/4
<b>P</b>	-	285	x	50	x	50	-	x	1	1/4
<b>Z</b>	-	900	x	120	x	16	-	x	2	1/4

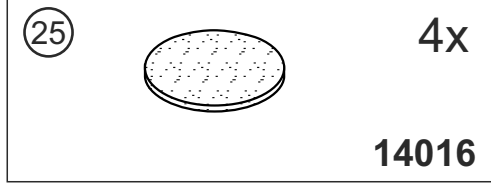
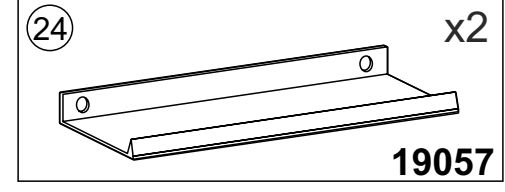
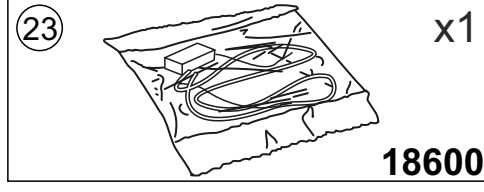
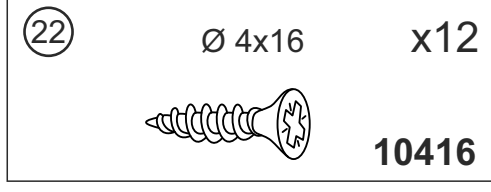
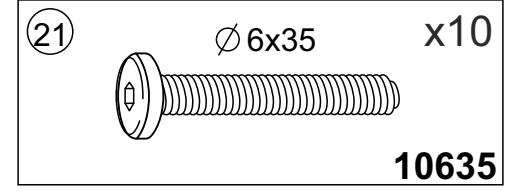
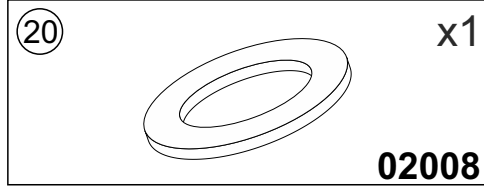
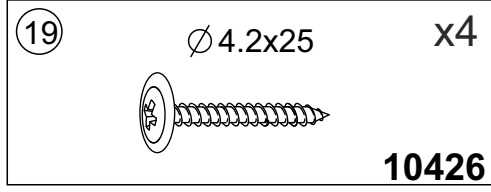
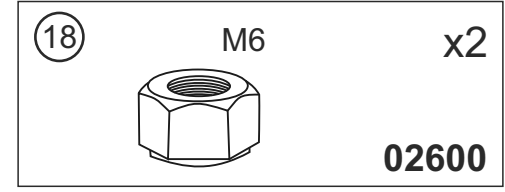
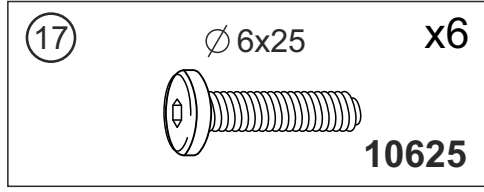
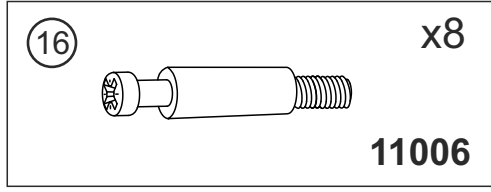
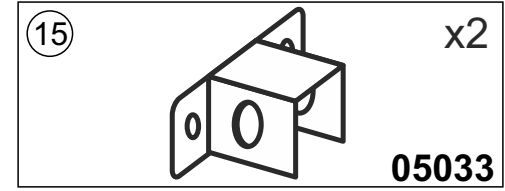
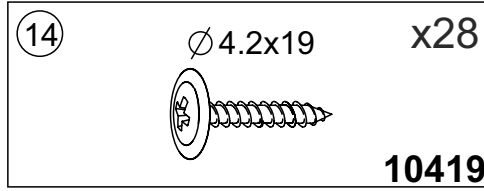
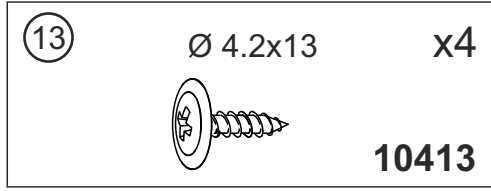
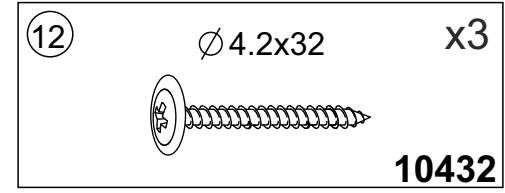
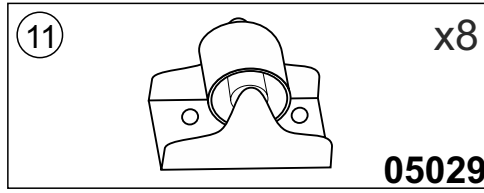
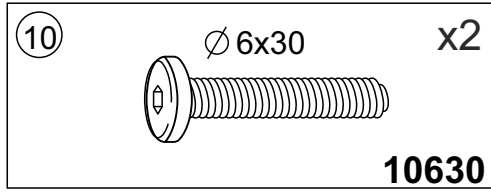
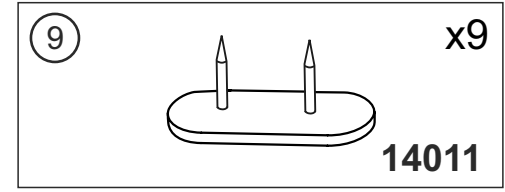
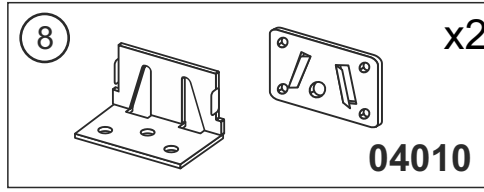
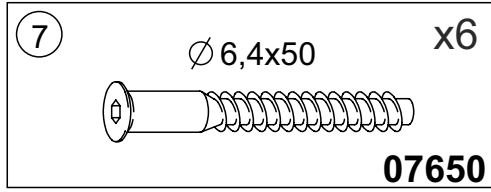
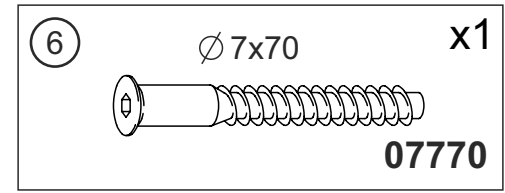
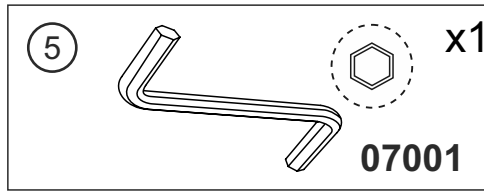
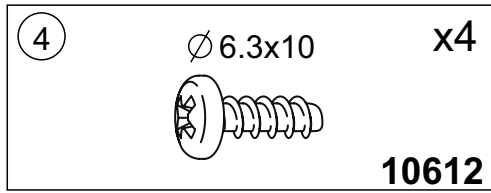
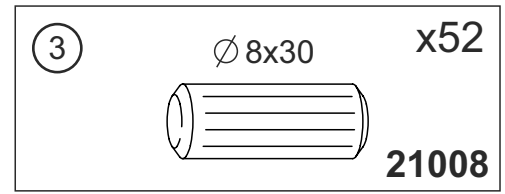
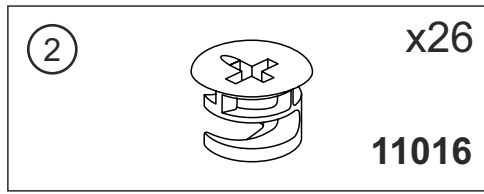
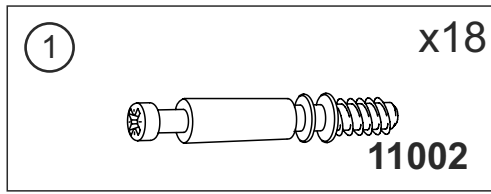

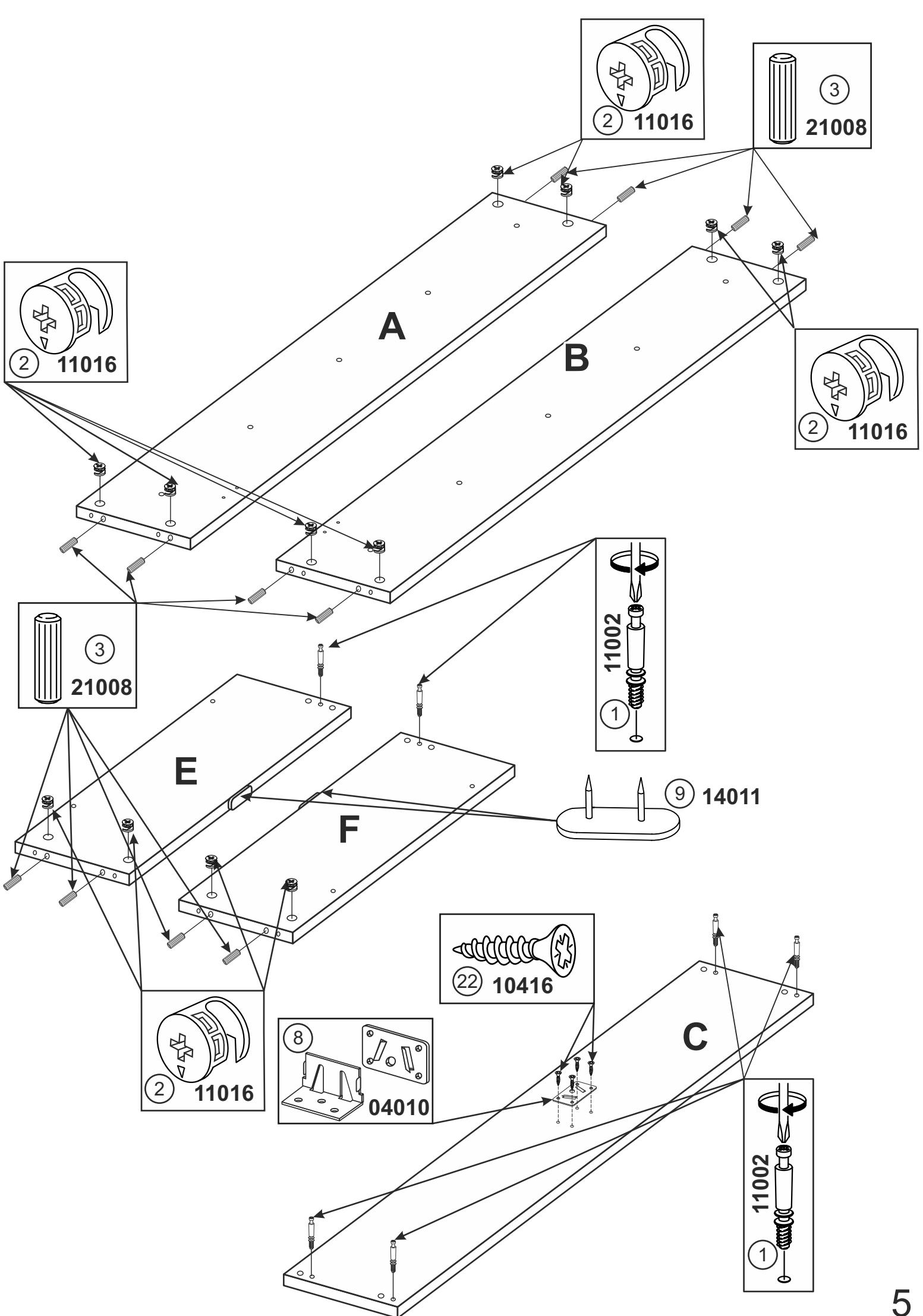

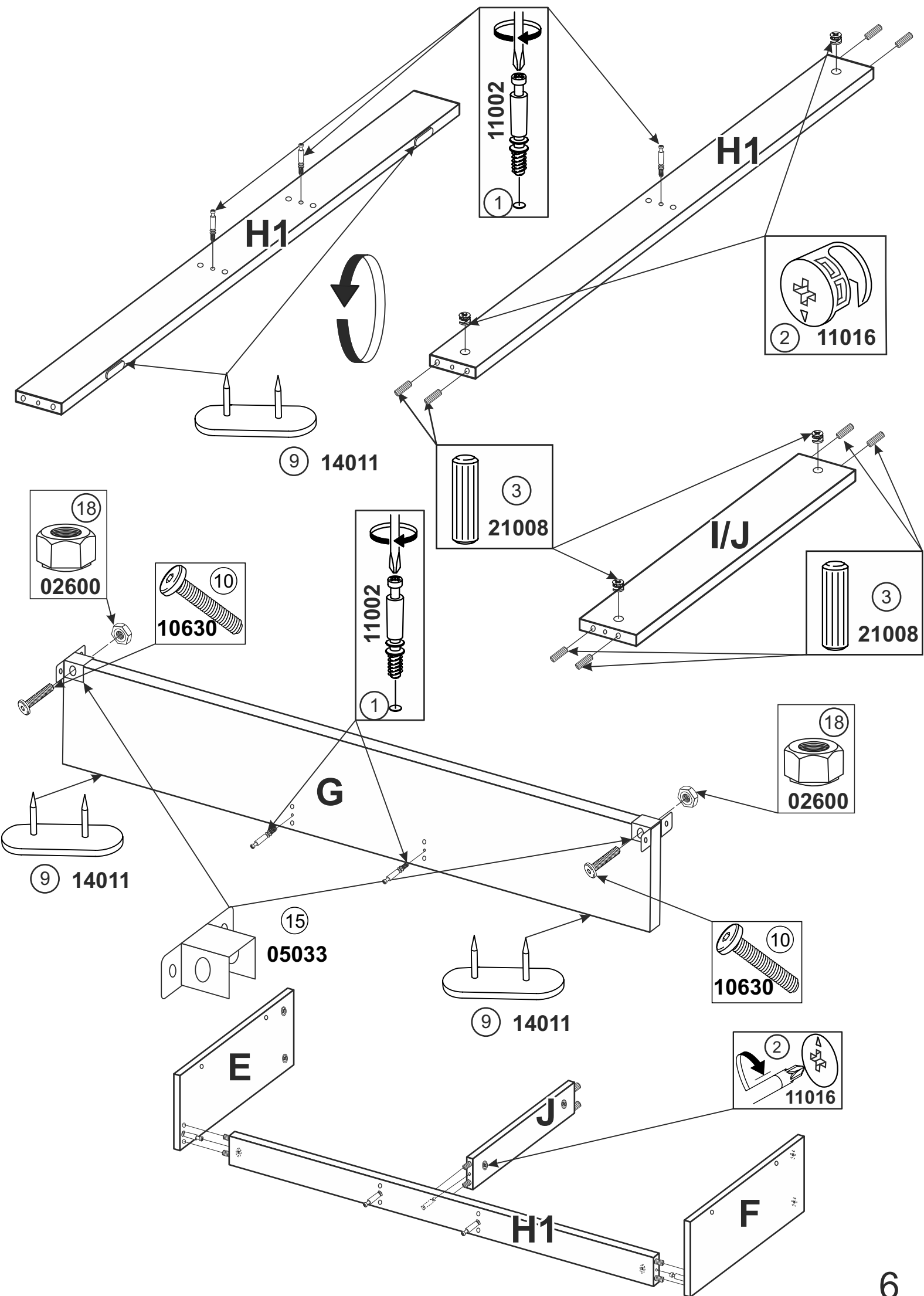

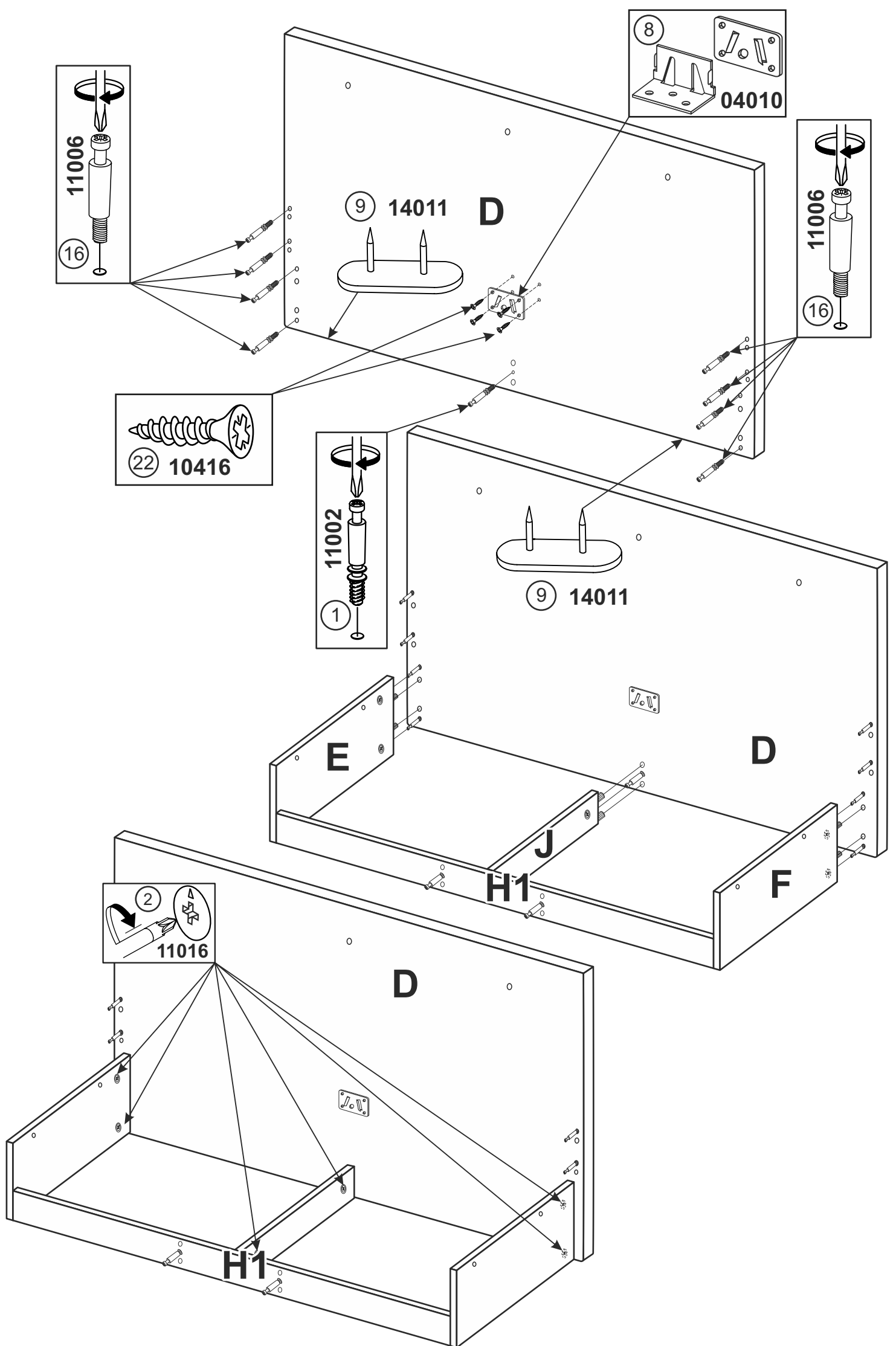

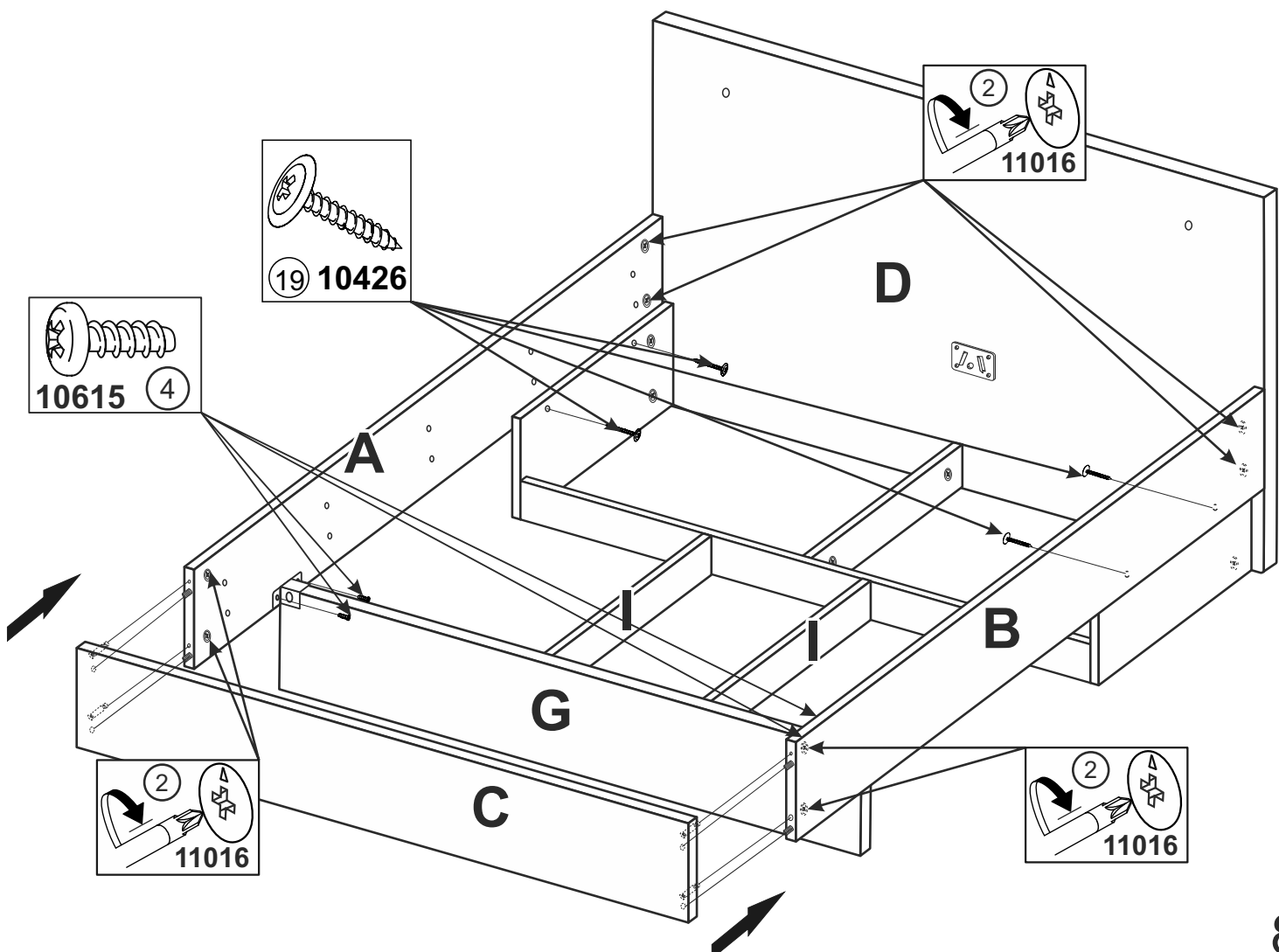
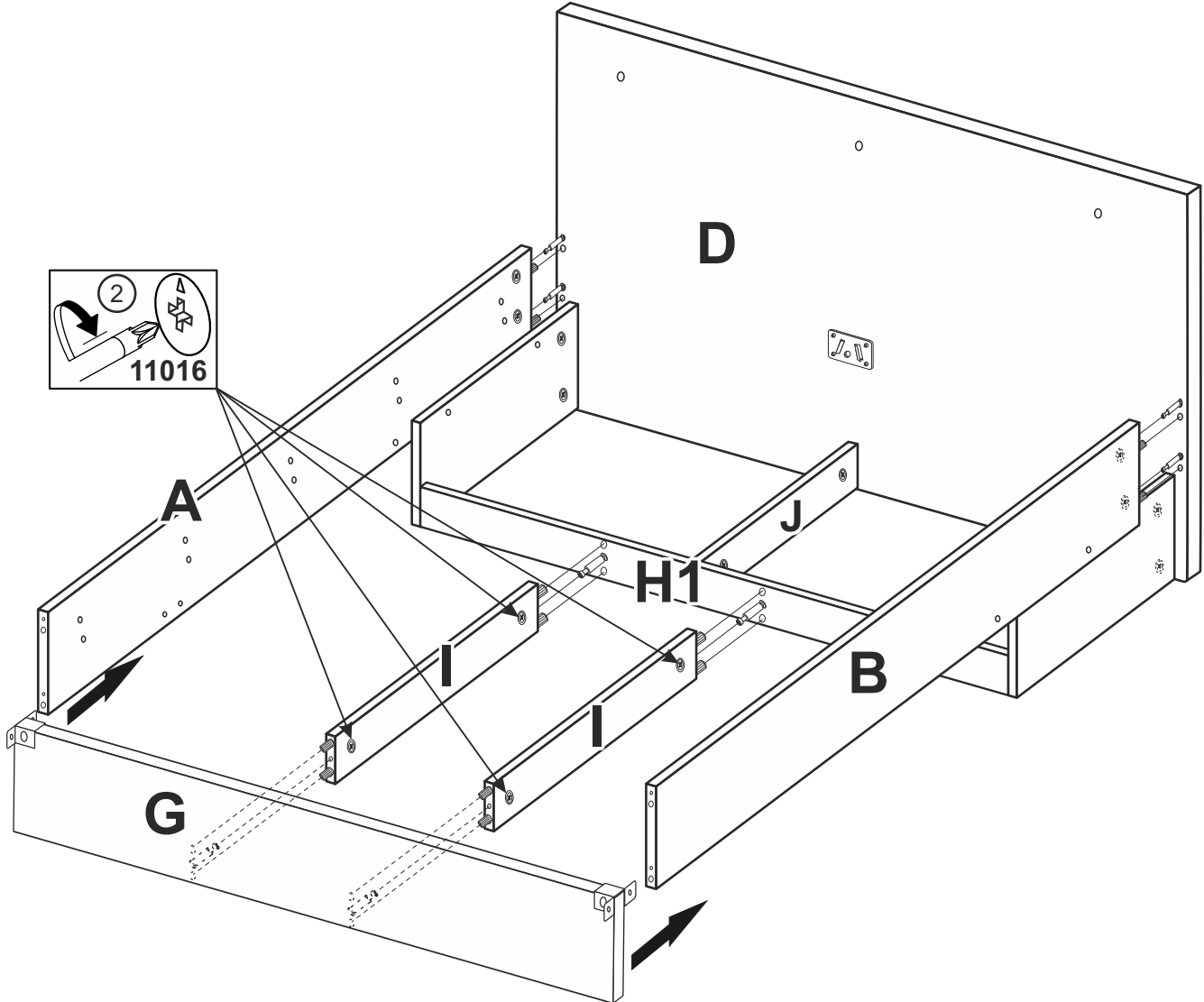



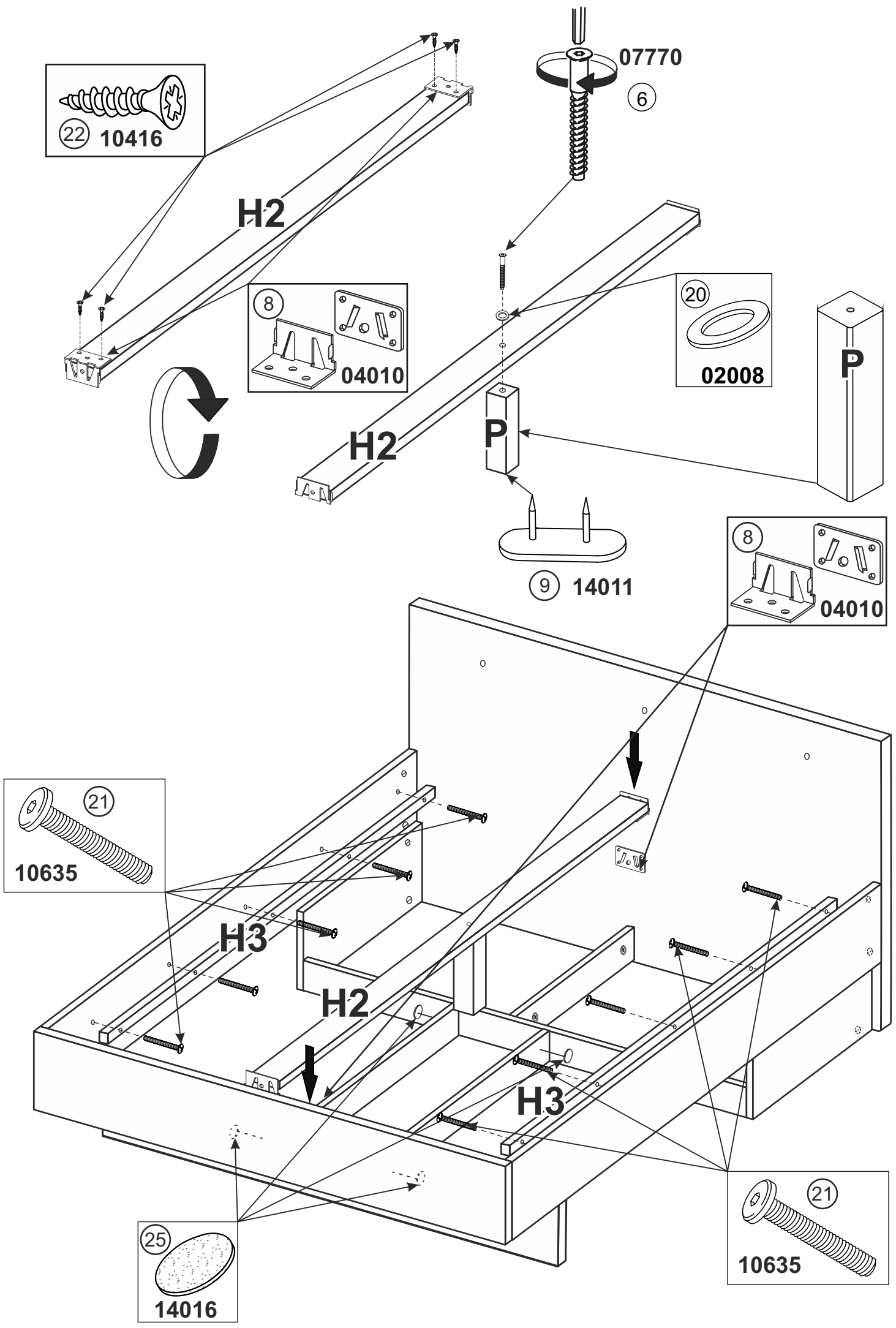

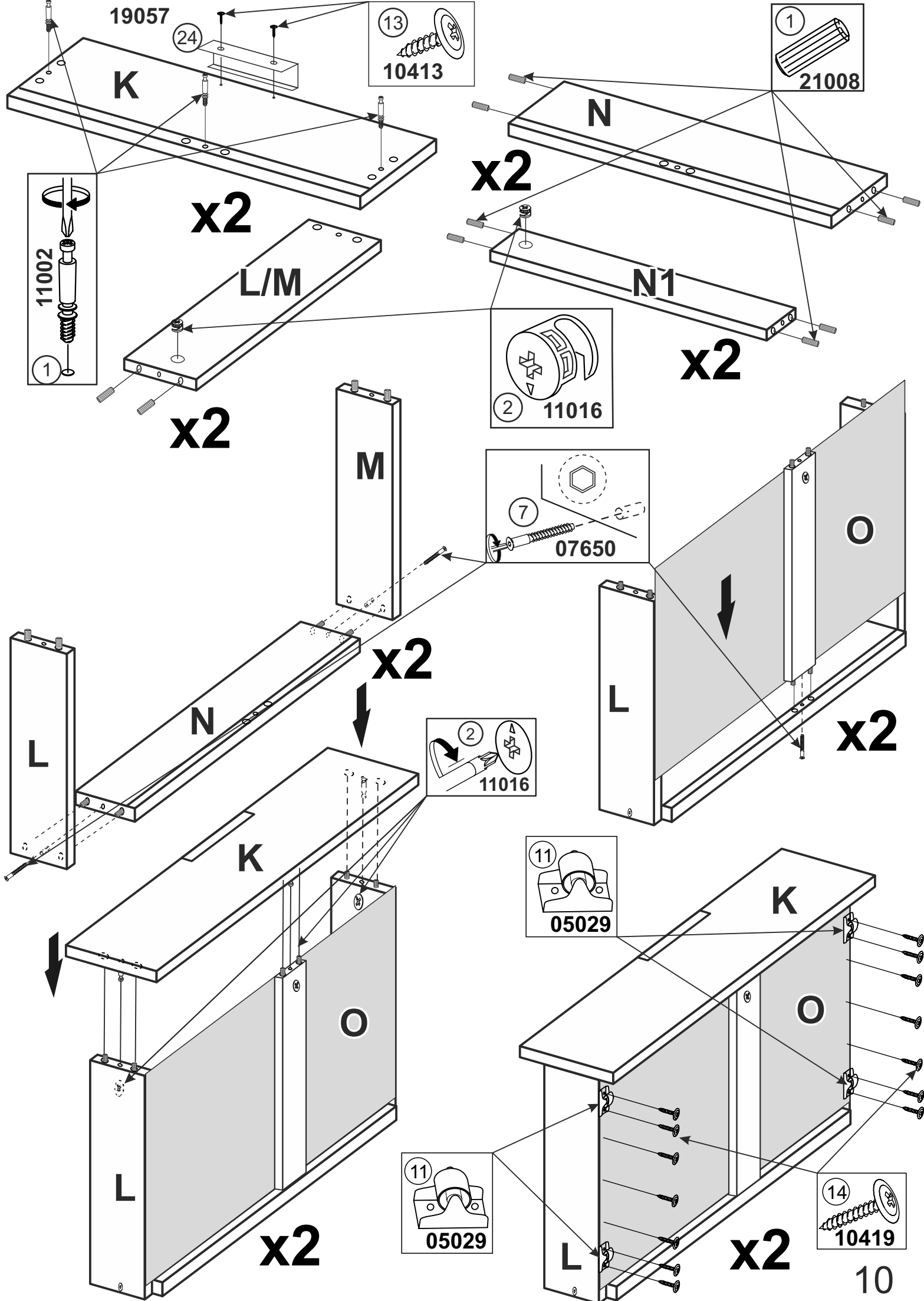

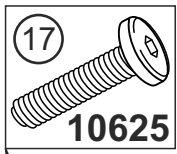

**D1**

**Z**

**D**

**Z**

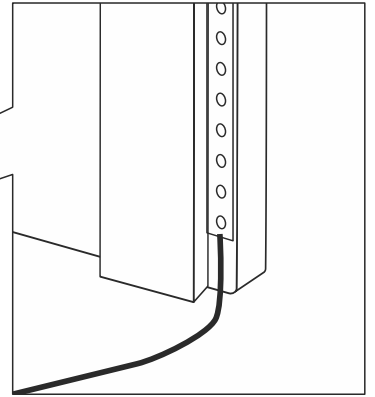
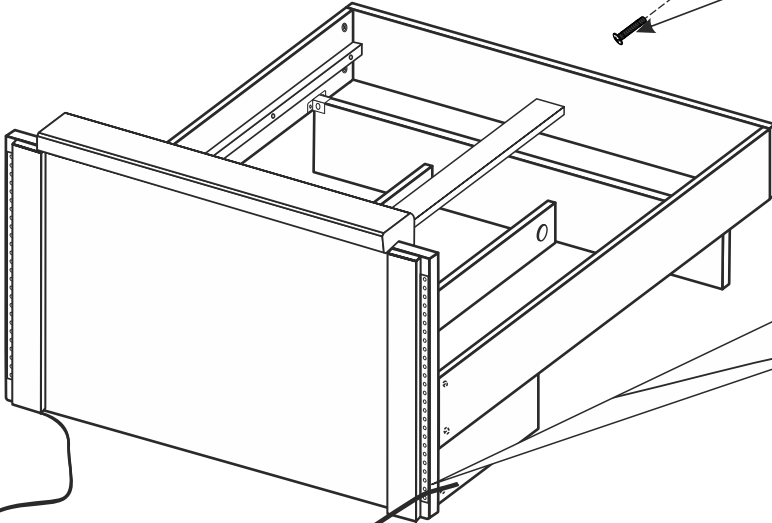
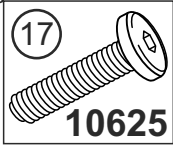
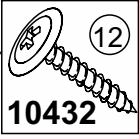

**B**

**C**

**23**

**18600**

**A**

