











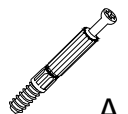
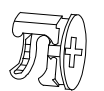



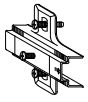
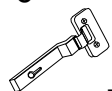
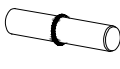

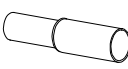

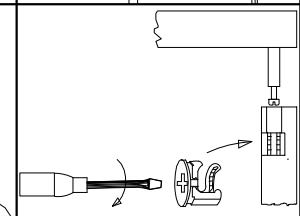
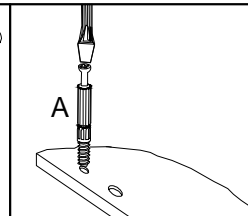
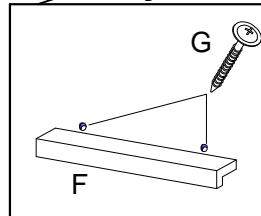
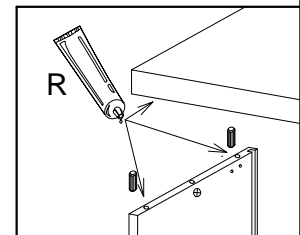
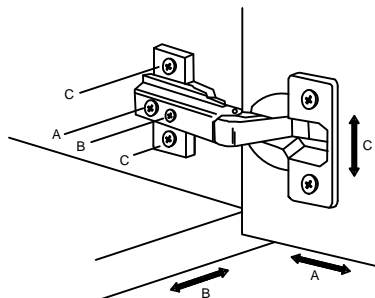
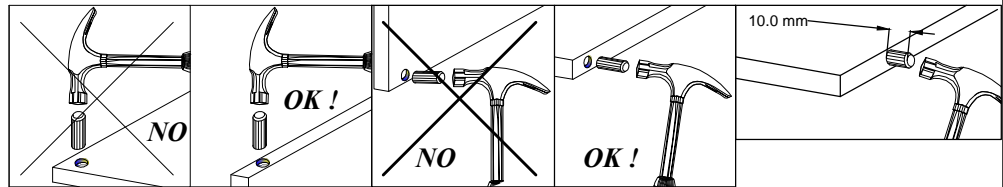
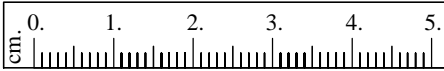
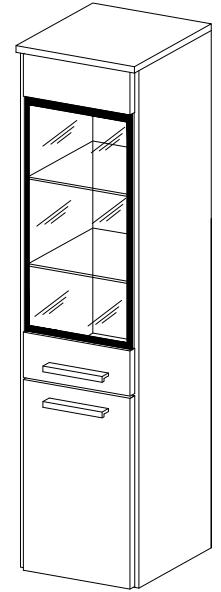
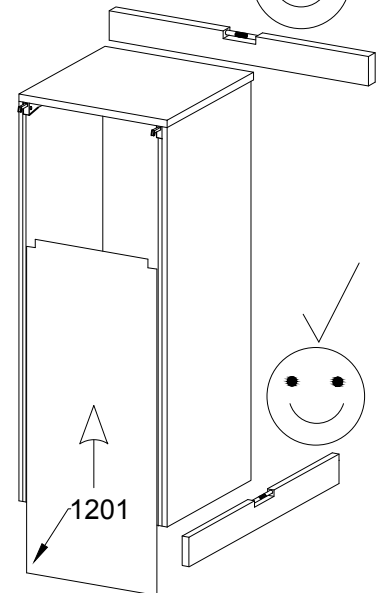
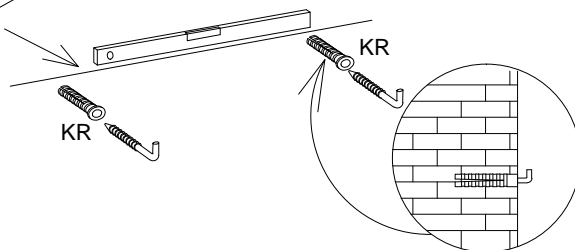
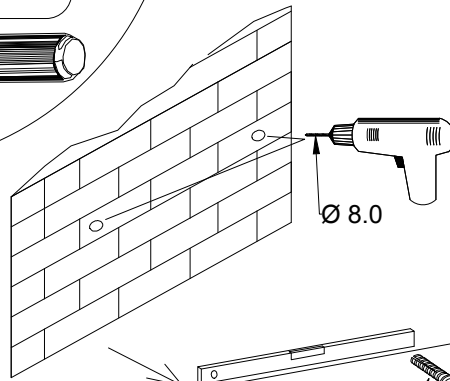
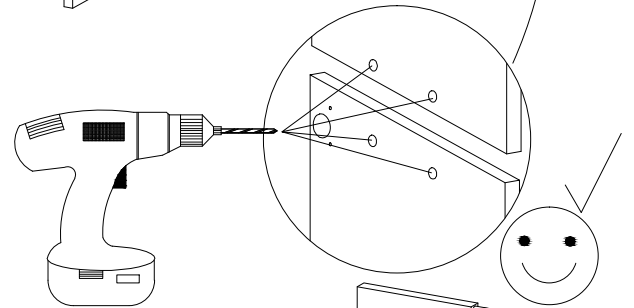
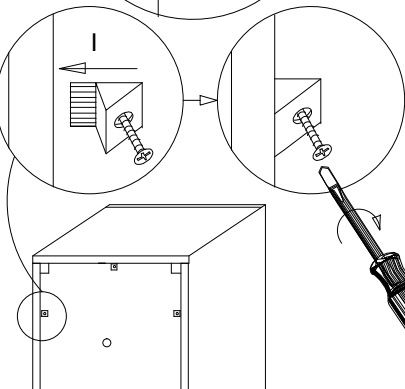
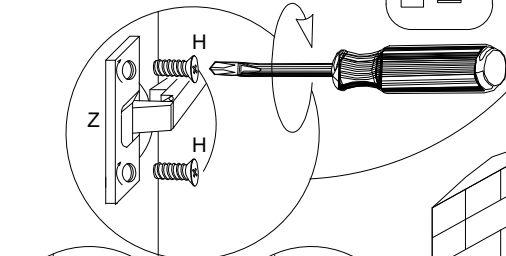
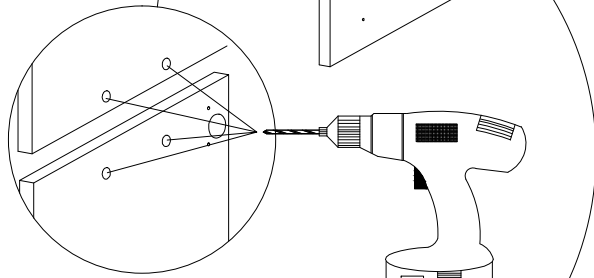
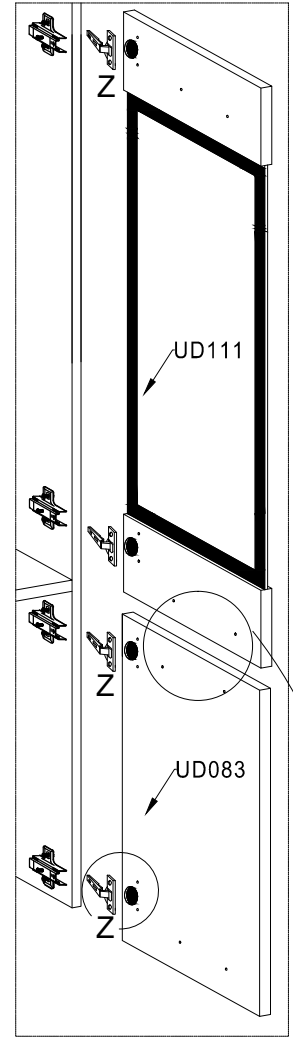
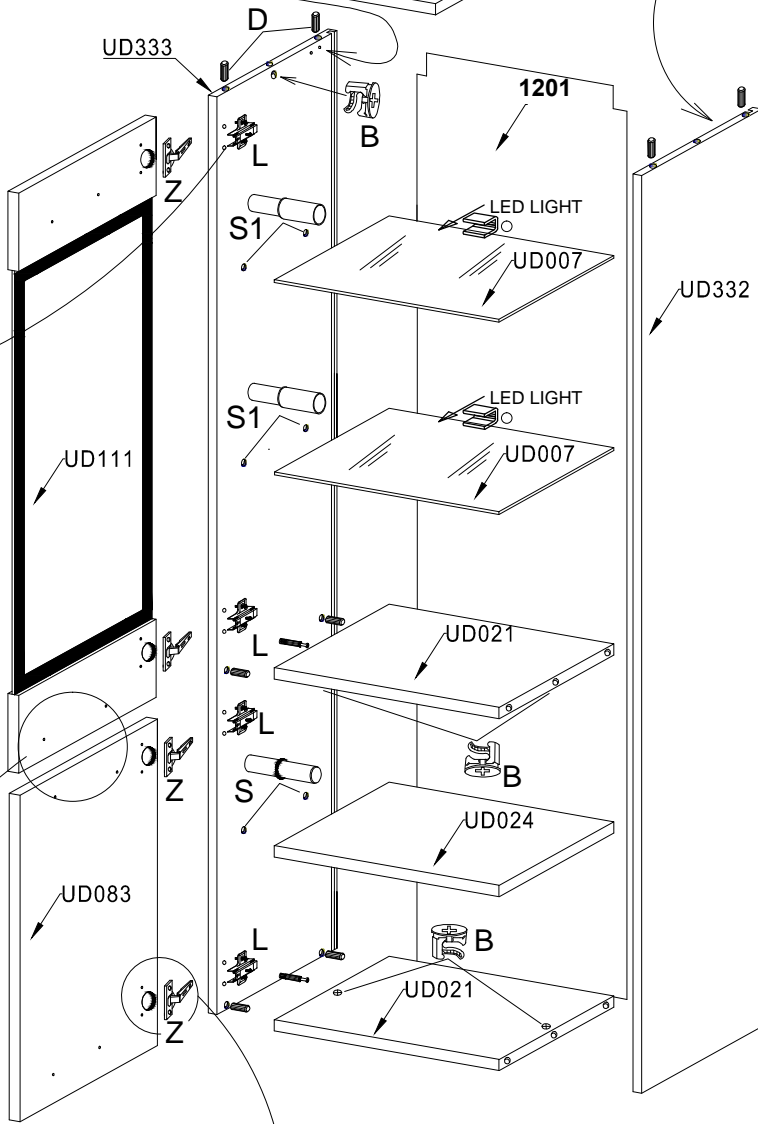
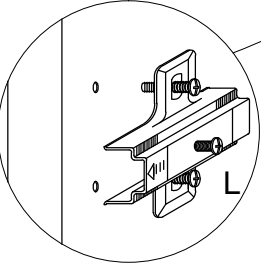
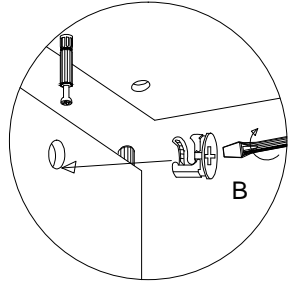
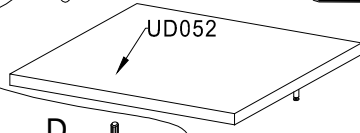
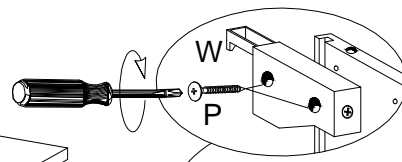
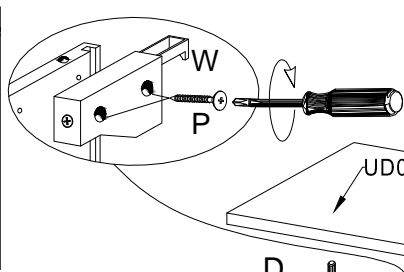
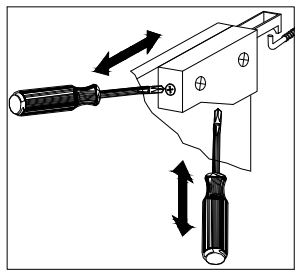
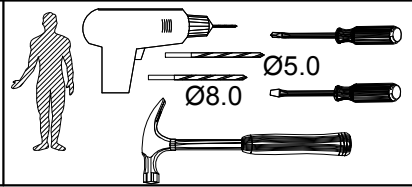

 W	 I	 4.0X27 G	 8.0X30 D	 A	 B	 R	
2	6	4	12	6	6	1	
 H	 4.0X30 P	 L	 "0" Z	 S	 F	 S1	 Ø 8.0 KR
8	4	4	4	4	2	8	2

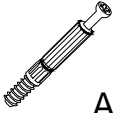



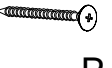

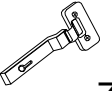
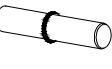
 W	 I	4.0X27  G	8.0X30  D	 A	 B	 R	Ø 8.0  KR
2	6	4	12	6	6	1	2
6.3x13  H	4.0X30  P	 L	"0"  Z	 S	 F	 S1	
8	4	4	4	4	2	4	

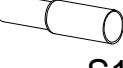