











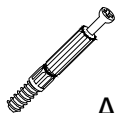





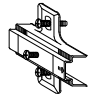
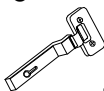
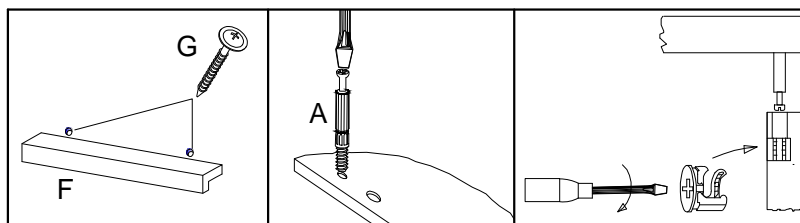
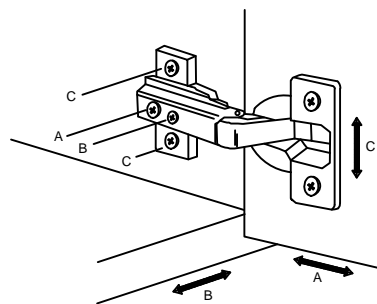
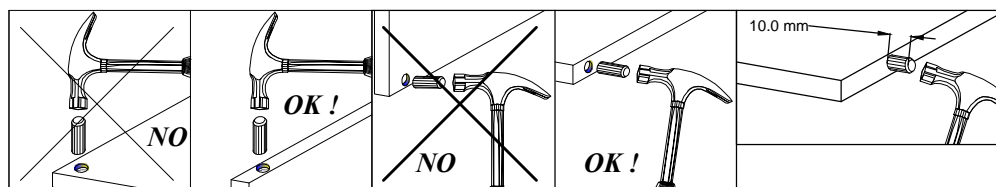
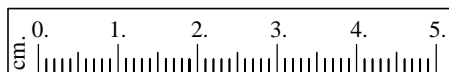
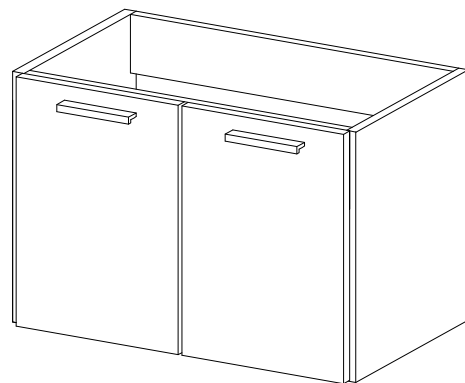
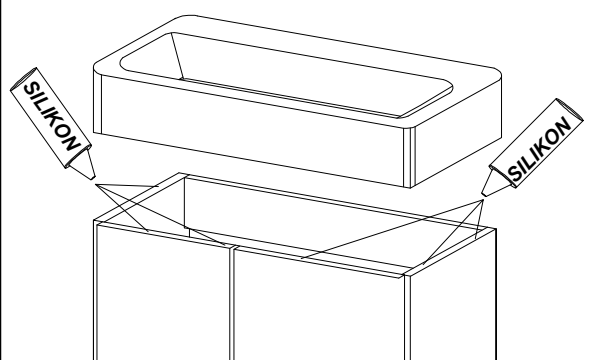
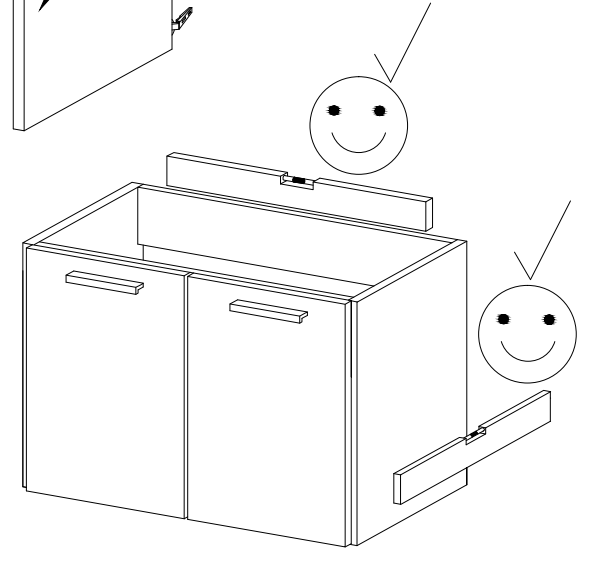
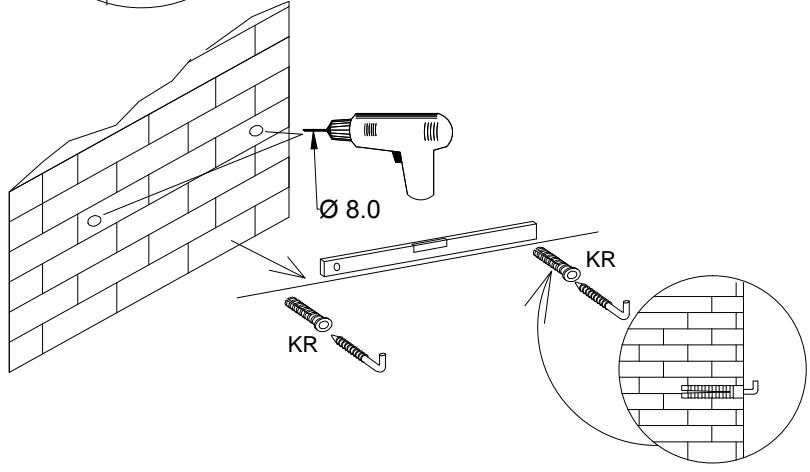
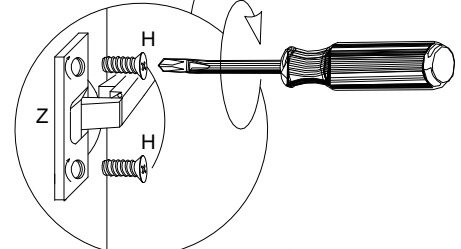
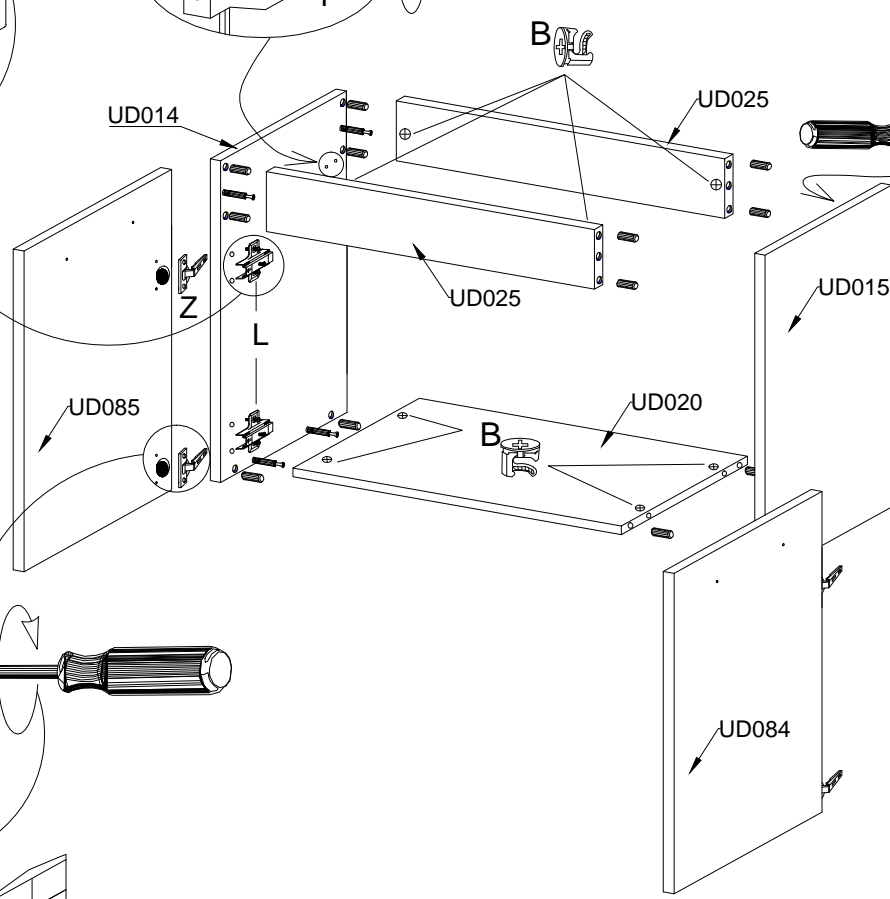
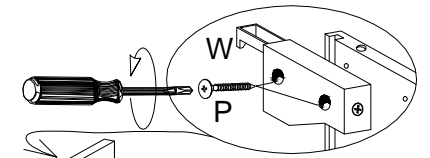
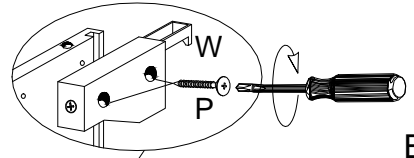
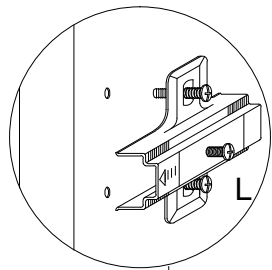
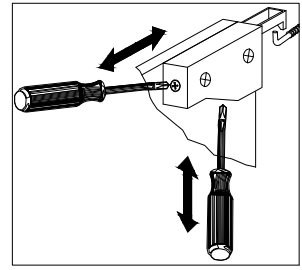
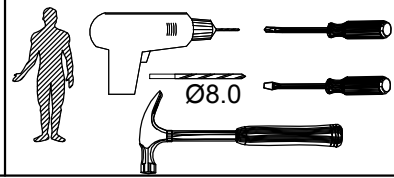

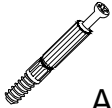

 W	 4.0X27 G	 8.0X30 D	 A	 B	 Ø 8.0 KR
2	4	12	8	8	2
 6.3x13 H	 4.0X30 P	 F	 L	 "0" Z	
8	4	2	4	4	





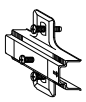
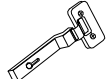

 W	 I	 8.0X30 D	 A	 B	 R	 Ø 8.0 KR
2	8	8	4	4	1	2
 H	 P	 L	 "0" Z	 S	 S1	 X
8	4	4	4	4	4	4

