

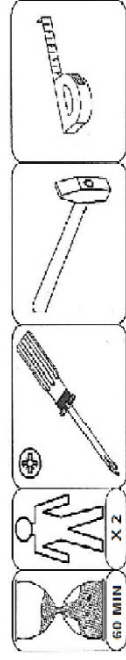













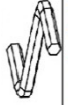

R-80D1P4



(A1) X 34 8x30 	(C2) x8 euro 6,3x13 	(ZN) X4 	
(SP) X8 	(W4) X8 	(NI) X8 t 3,5x13 	
(M) X1 L11x7 	(O2) X4 	(KF) X6 t 7 x 50 	
(P1) X16 5x11 	(G4) X100 		
(F1) X14 Trzpień Mimośrodowo 	(E1) X14 		(X14) X14 

R-80D1P4

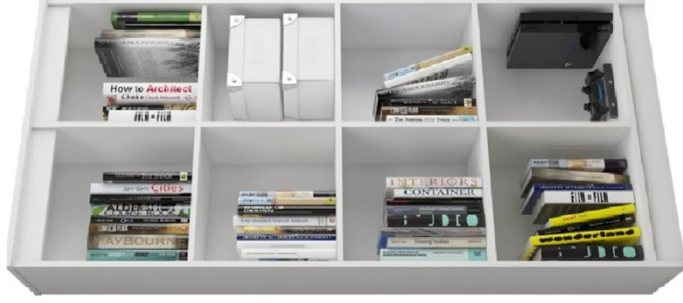
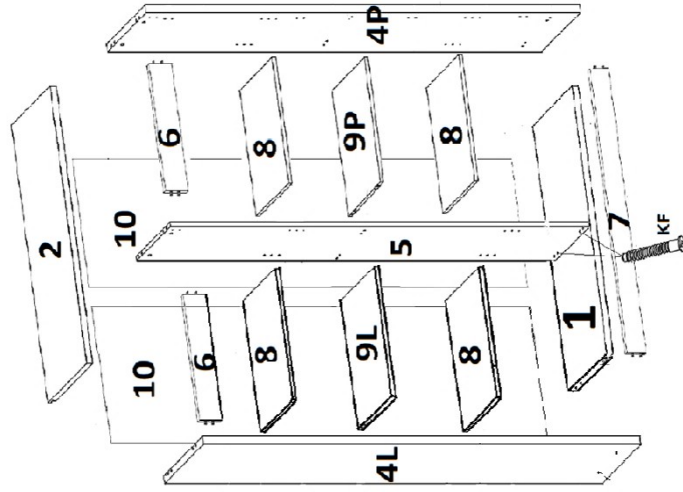
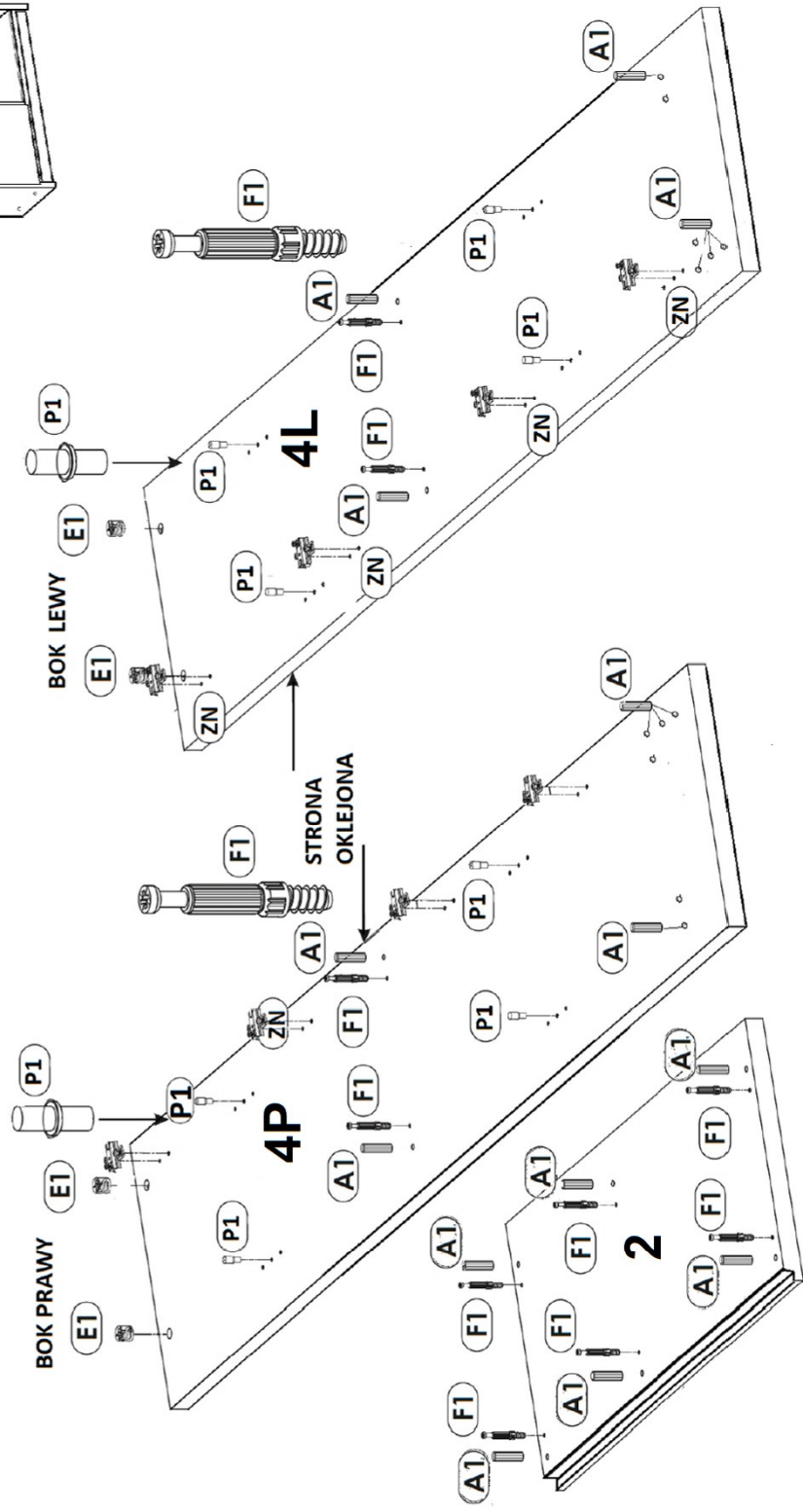
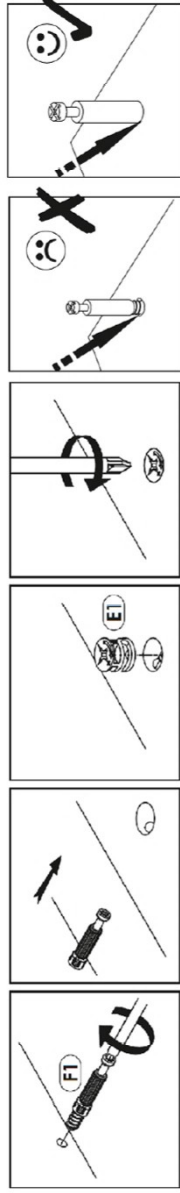
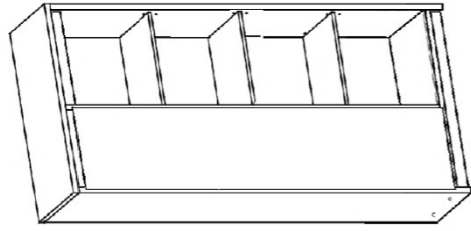

R-80D1P4

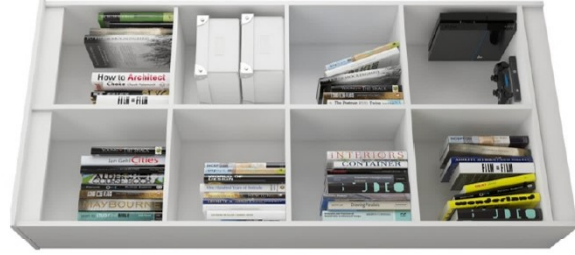
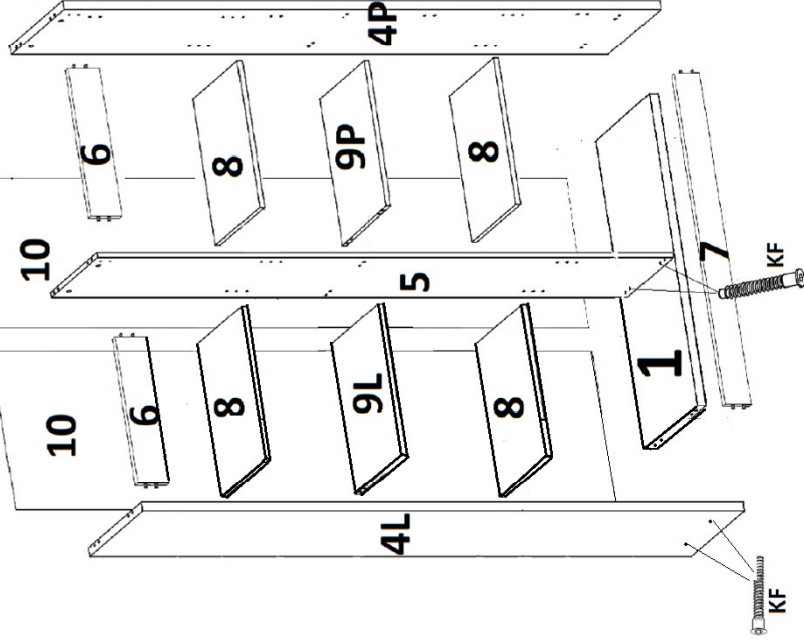
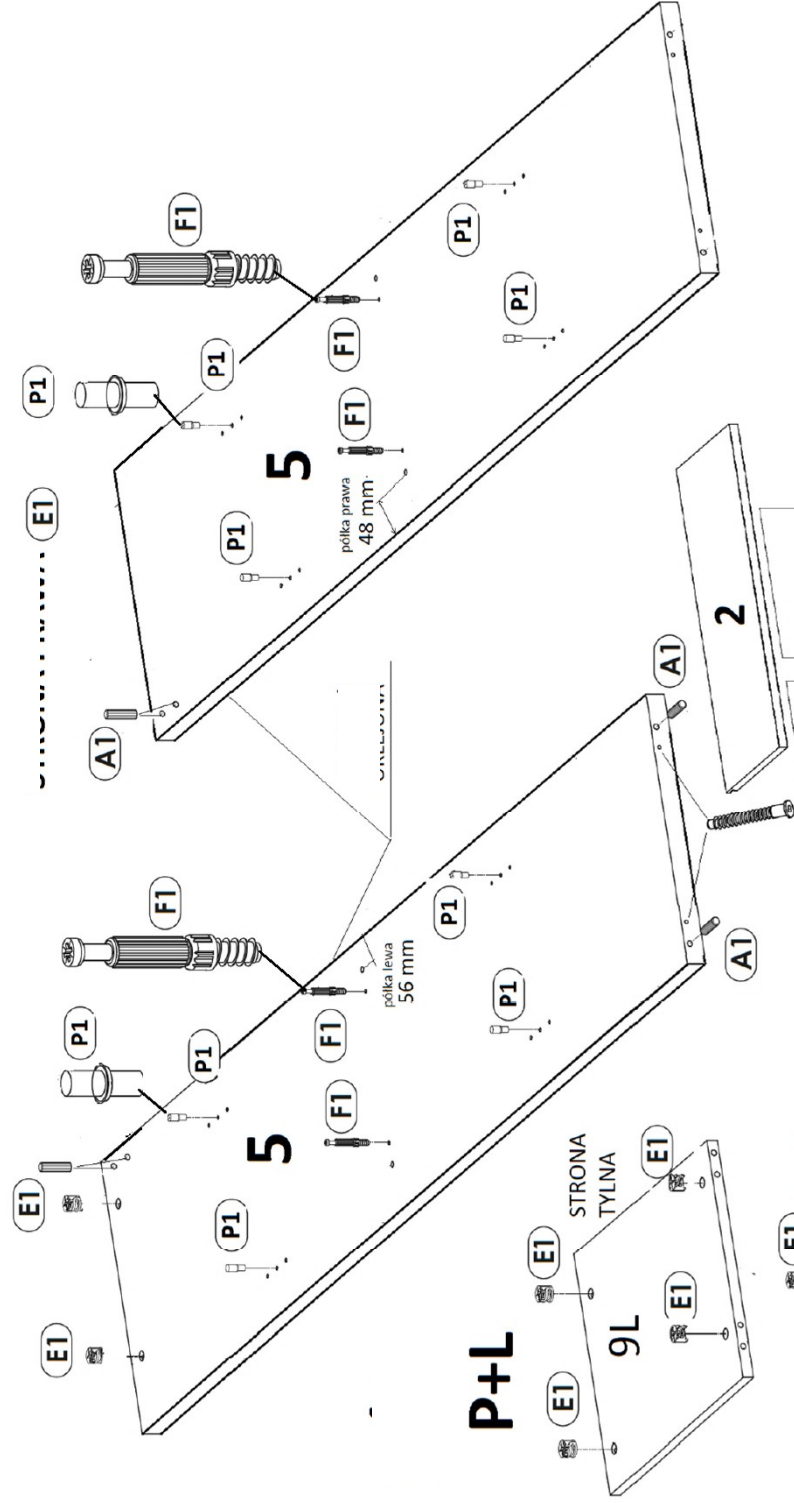
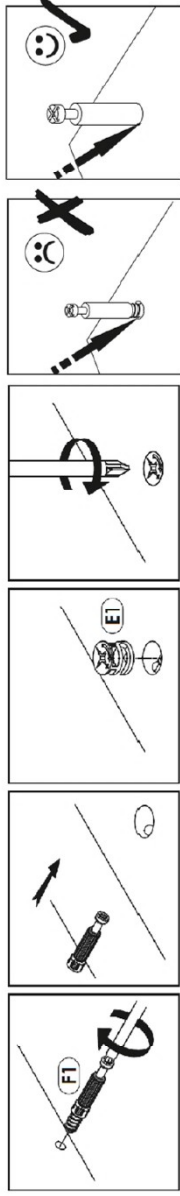

R-80D1P4

