

(PL) Instrukcja montażu

(CZ) Návod k montáži

(D) Montageanleitung

(GB) Assembly instruction

(F) Model d'emploi

(HU) Szerelési útmutató

(I) Istruzione di montaggio

(NL) Handleiding voor de montage

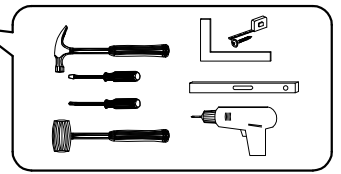
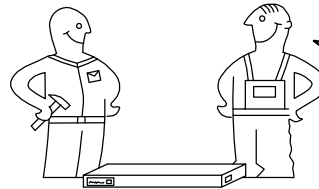

(RU) Инструкция по монтажу

(RO) Instrucțiuni de montare

(SK) Návod k montáži

(TR) Montaj talimatı

**⚠ Uwaga • Upozornění • Achtung • Attention • Caution • Figyelem
Attenzione • Opgelet • Внимание • Atenție • Upozornenie • Dikkat ⚠**

PL Czystczenie należy wykonać wyłącznie za pomocą ściereczki lub lekko nawilżonego ręcznika. Nie stosować środków czyszczących do szorowania.

CZ Čistění je nutné vykonávat výhradně pomocí utěrky nebo lehké navlhčeného ručníku. Nepoužívejte čisticí prostředky obsahující abrazivní částice.

D Bitte nur mit einem Staubtuch oder leicht feuchtem Lappen reinigen. Keine scheuernden Putzmittel verwenden.

GB Please only clean with a duster or a damp cloth. Do not use any abrasive cleaners.

F Le nettoyage se fait uniquement à l'aide d'un torchon ou d'une serviette légèrement mouillée.

HU A tisztítás kizárólag törölrúha vagy enyhén nedvesített törölköző segítségével végezhető. Súroló hatású tisztítószerket nem szabad használni.

I Pulire esclusivamente con un panno o un asciugamano umido.

NL Reinig alleen met een stofdoek of een lichtjes vochtige doek. Gebruik geen schurende poetsmiddelen.

RU Очищайте от пыли тряпкой или слегка влажной ветошью. Не допускается применение чистящих средств, не предназначенных для ухода за мебелью.

RO Curățarea trebuie efectuată numai cu o cârpă sau cu un prosop ușor umezit. Nu utilizați agenți de curățare abrazivi.

SK Čistení je nutné vykonávať výhradne pomocí utierky alebo ľahko zvlhnutým ručníkom. Nepoužívajte čistiace prostriedky obsahujúci abrazívni častice.

TR Lütfen sadece bir toz bezile veya hafif nemli yumuşak bir bezle siliniz. Aşındırıcı temizlik malzemeleri kullanmayınız.

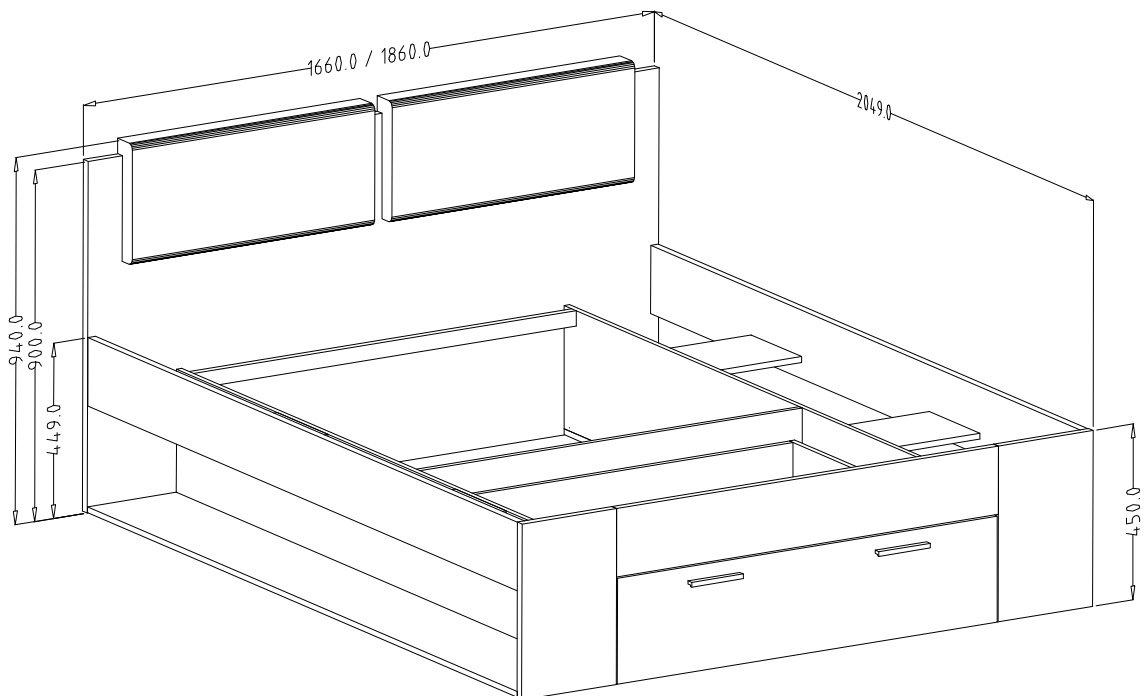
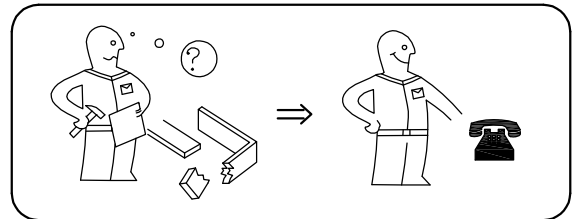
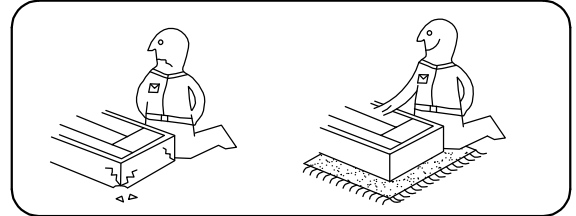

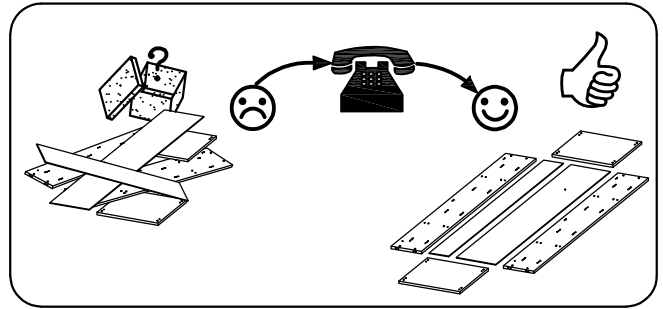
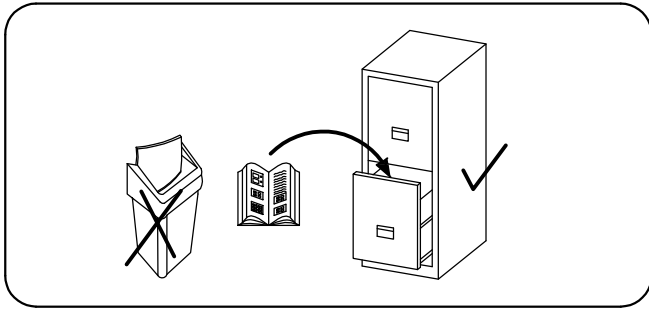

L - 1400 -

- GY-990
- GY-950
- GY-969
- GY-962
- GY-929
- GY-7490
- GY-069
- GY-190

L - 1600 -

- GY-991
- GY-951
- GY-971
- GY-963
- GY-930
- GY-7500
- GY-070
- GY-191

L - 1800 -

- GY-992
- GY-952
- GY-972
- GY-964
- GY-931
- GY-7510
- GY-071
- GY-192

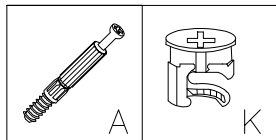
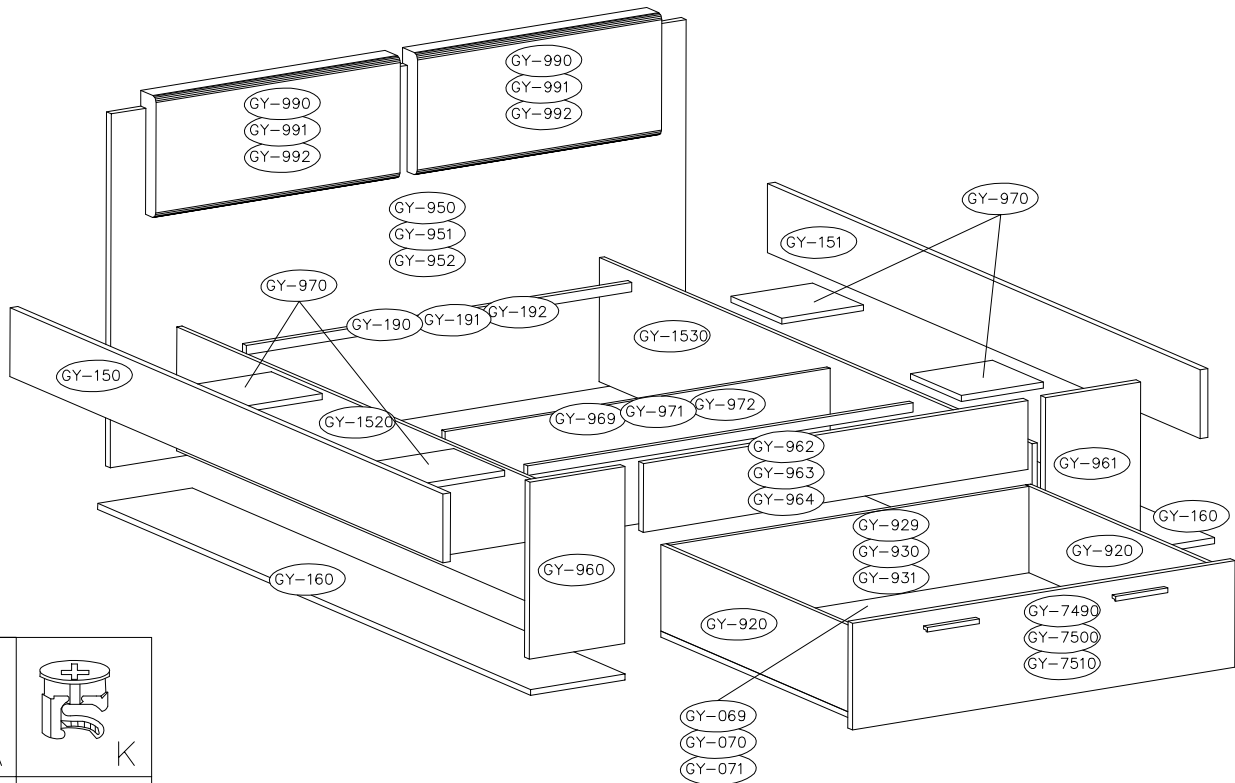

49

12

45	8	54	4	8	4	64	4	4	
4	12	4	8	1	4	8	2	1	12

1

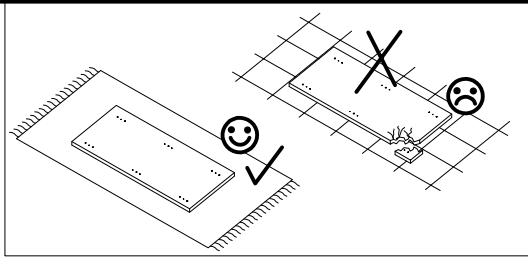

S1
4

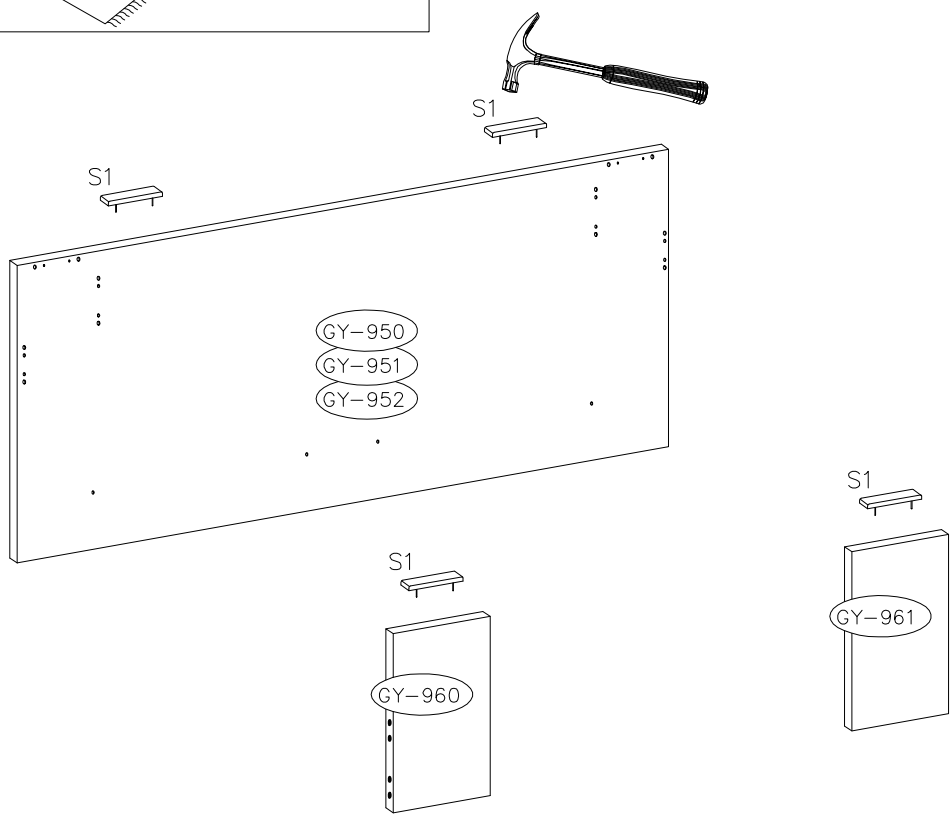

2

K	D2	F2	I
8	4	4	1

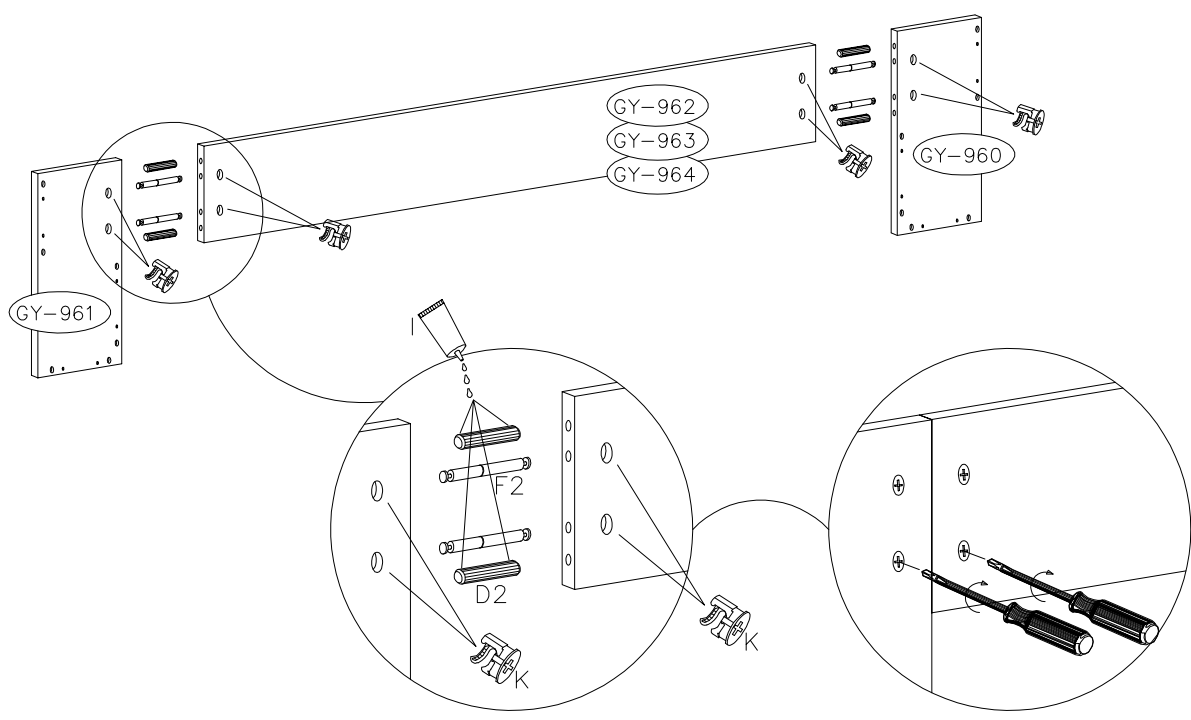

3



A

12

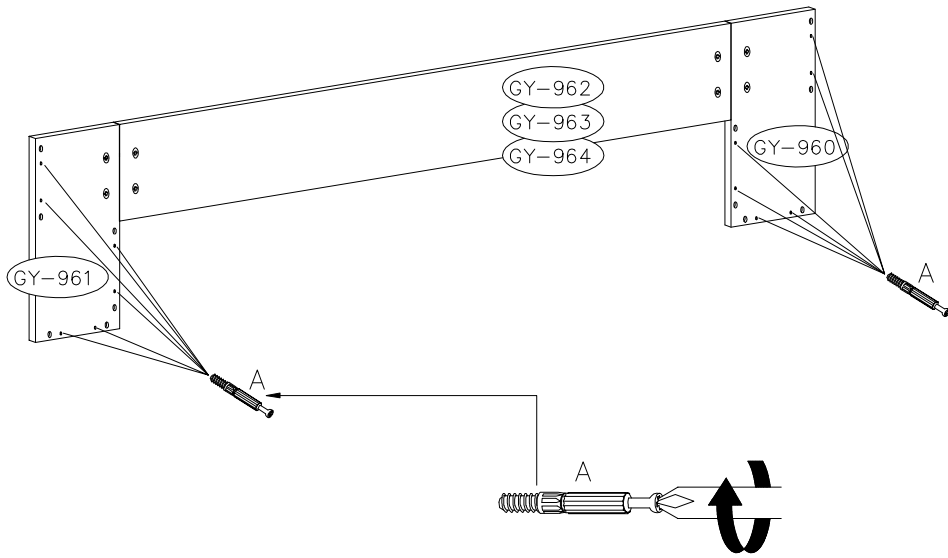

4







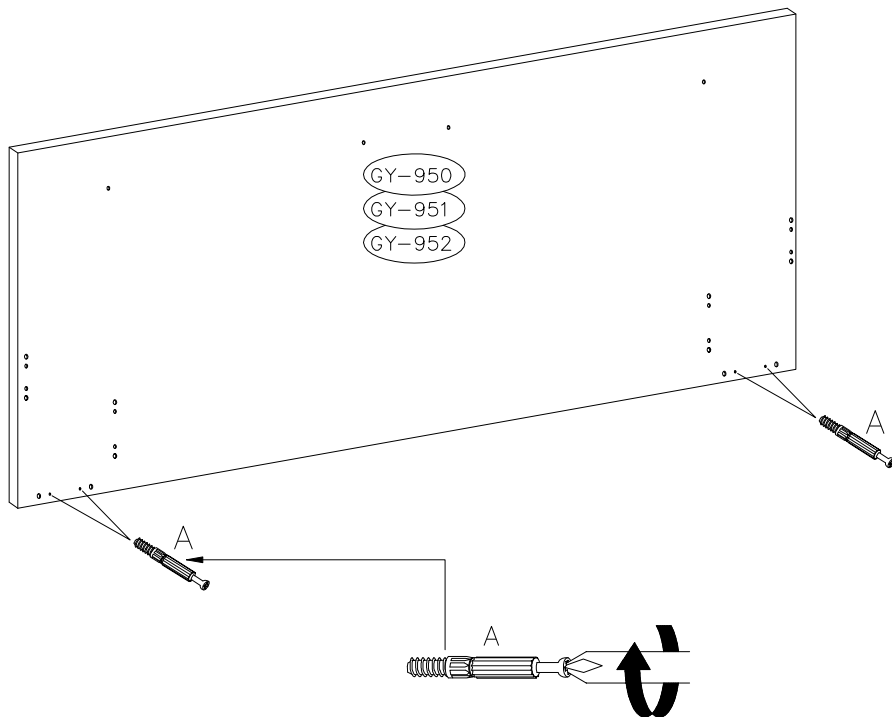

A

4



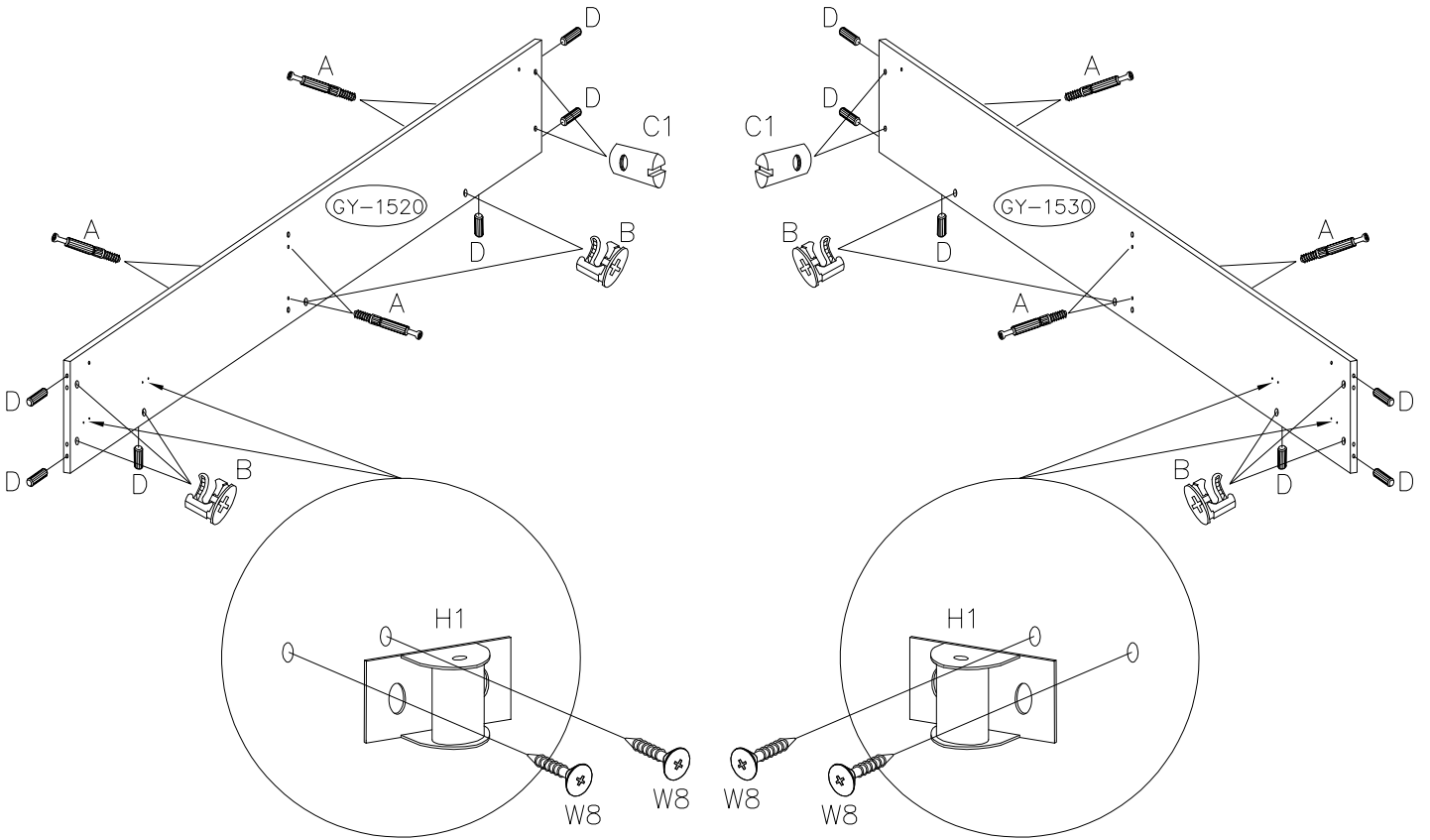

5

10X13  C1	 B	8.0X30  D	 A	3.5X13  W8	7.404  H1
4	10	12	12	8	4







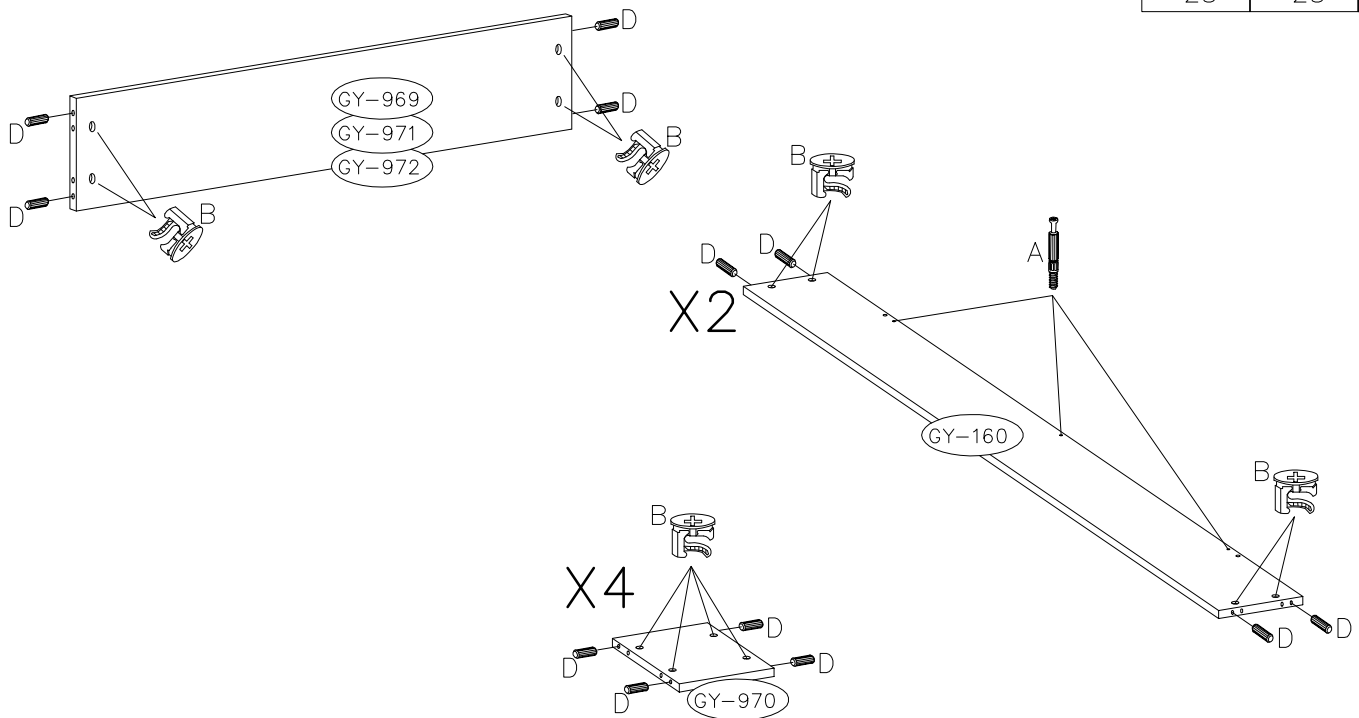

6

 B	8.0X30  D	 A
28	28	6



7

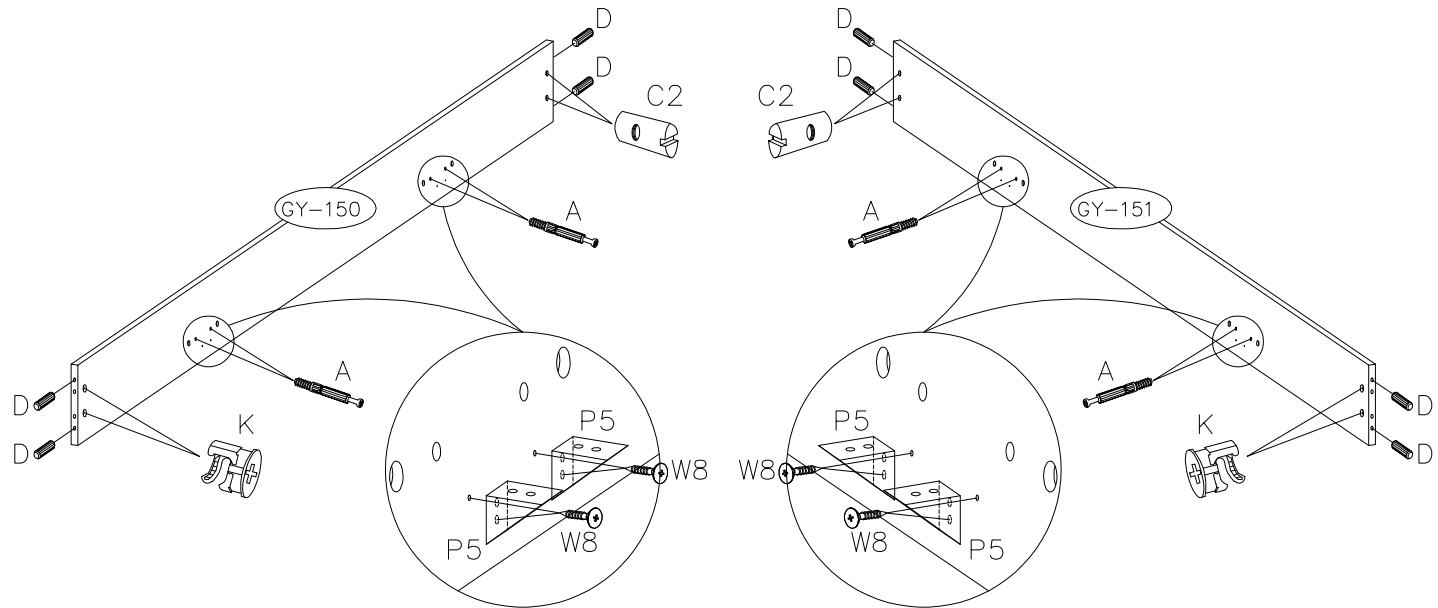

10X17  C2	 K	8.0X30  D	 A	3.5X13  W8	 P5
4	4	8	8	16	8

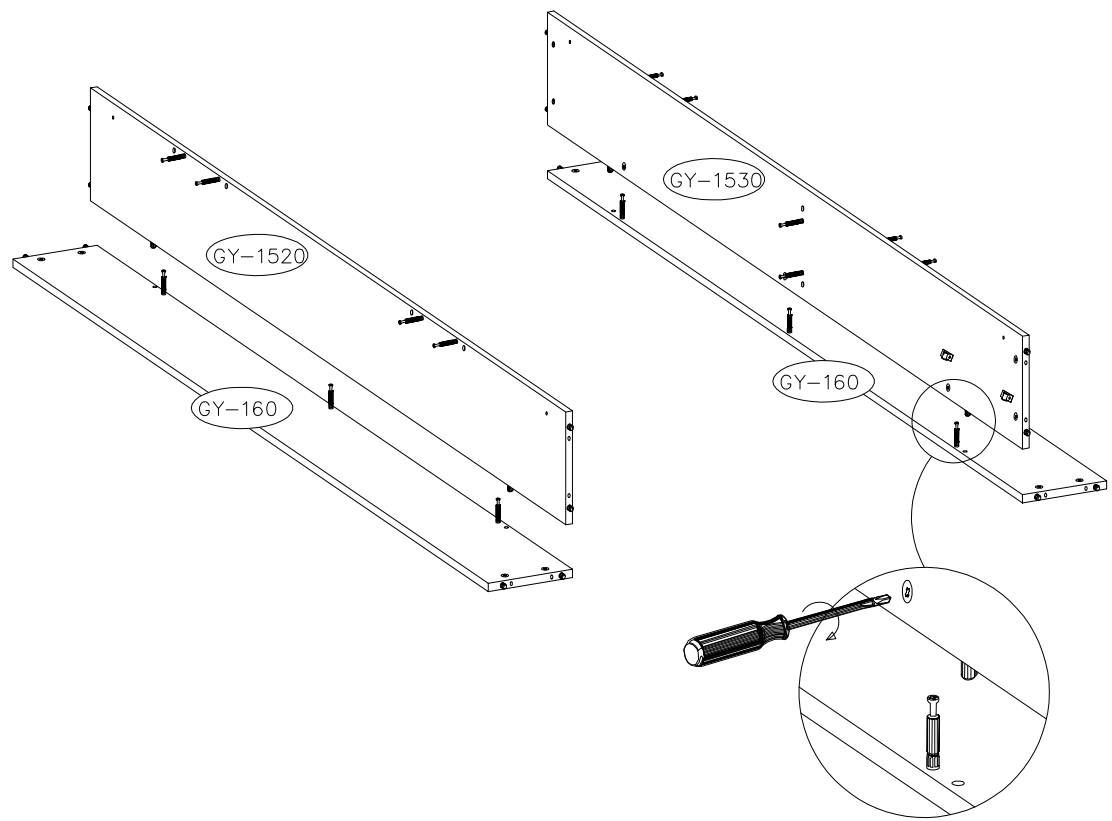

8



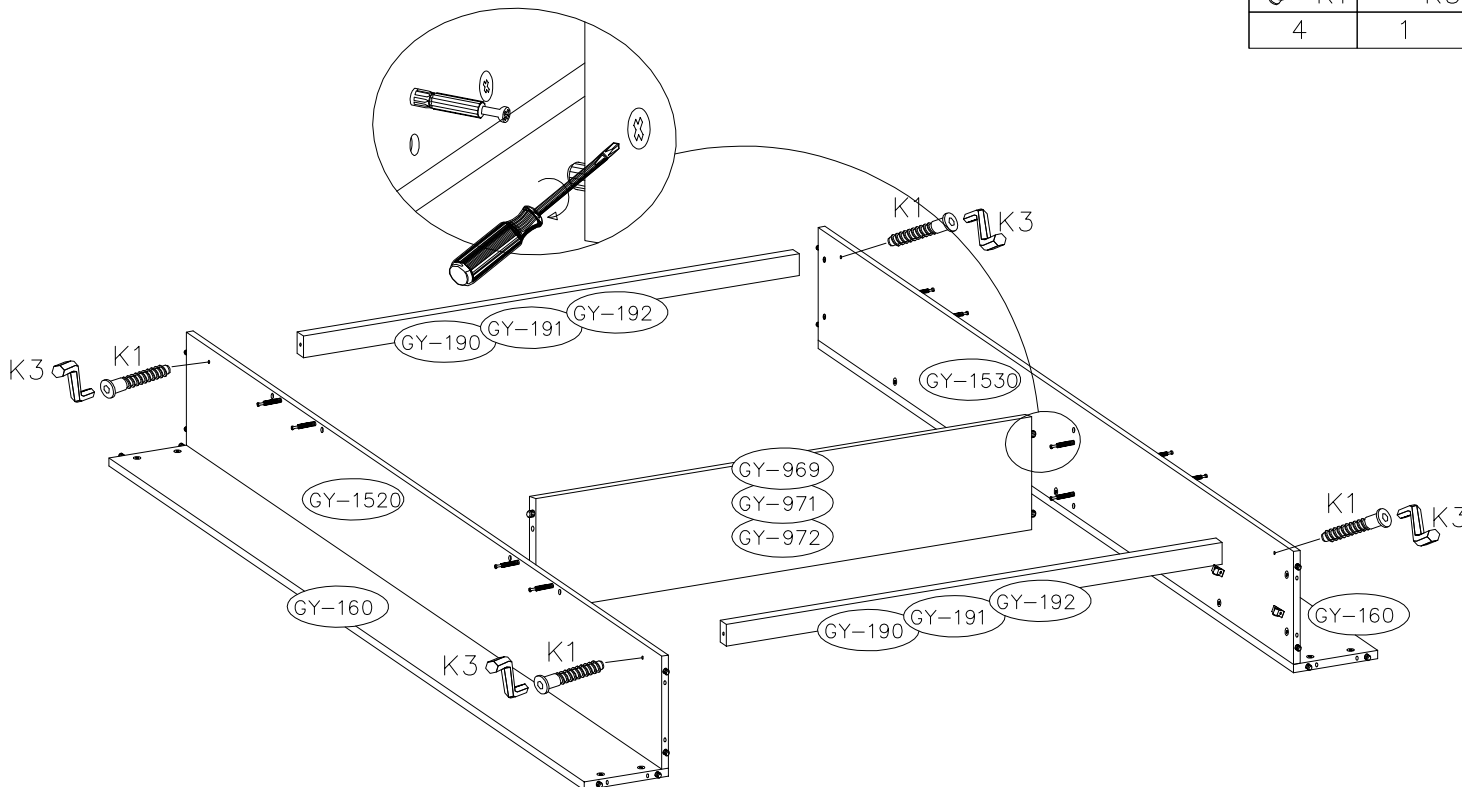

9

6.4X50 	4mm 
K1	K3
4	1



10

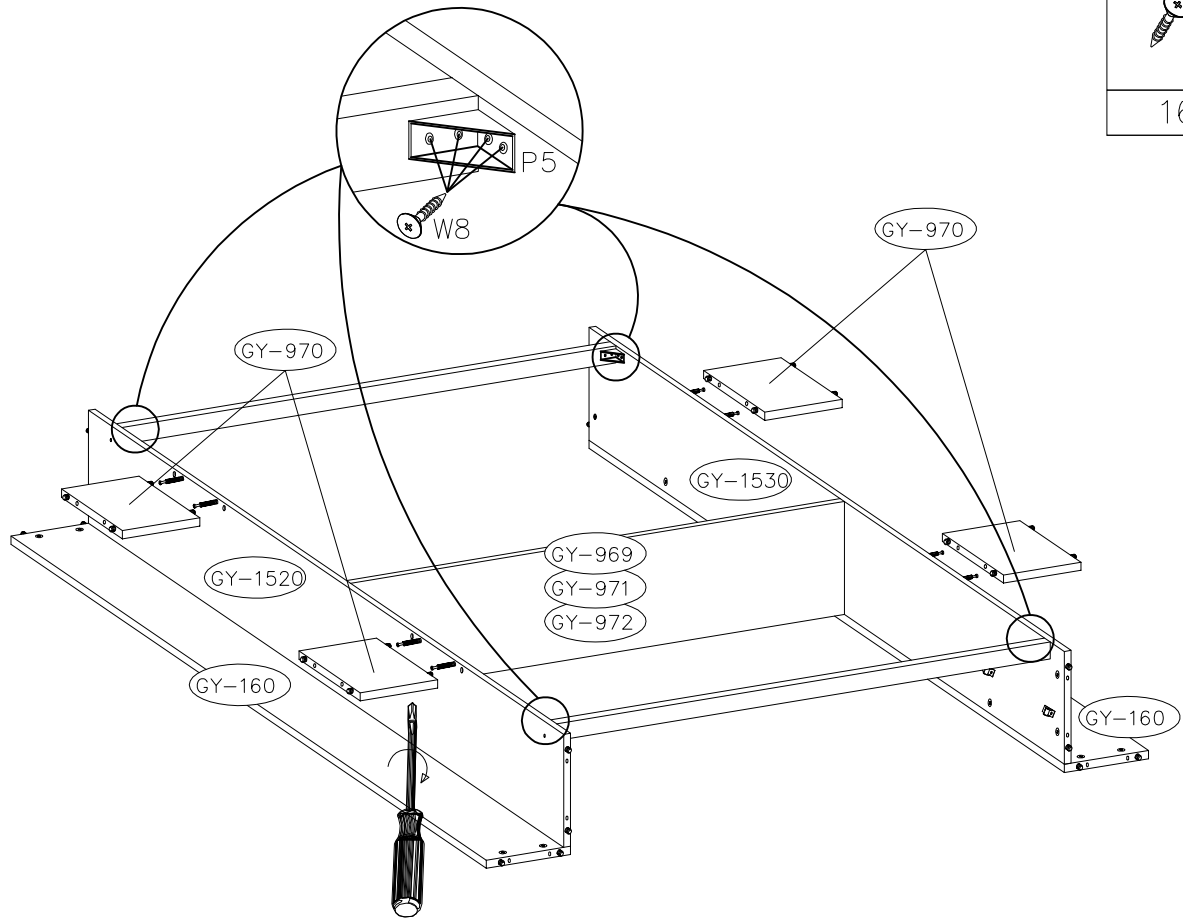

3.5X13 	
W8	P5
16	4

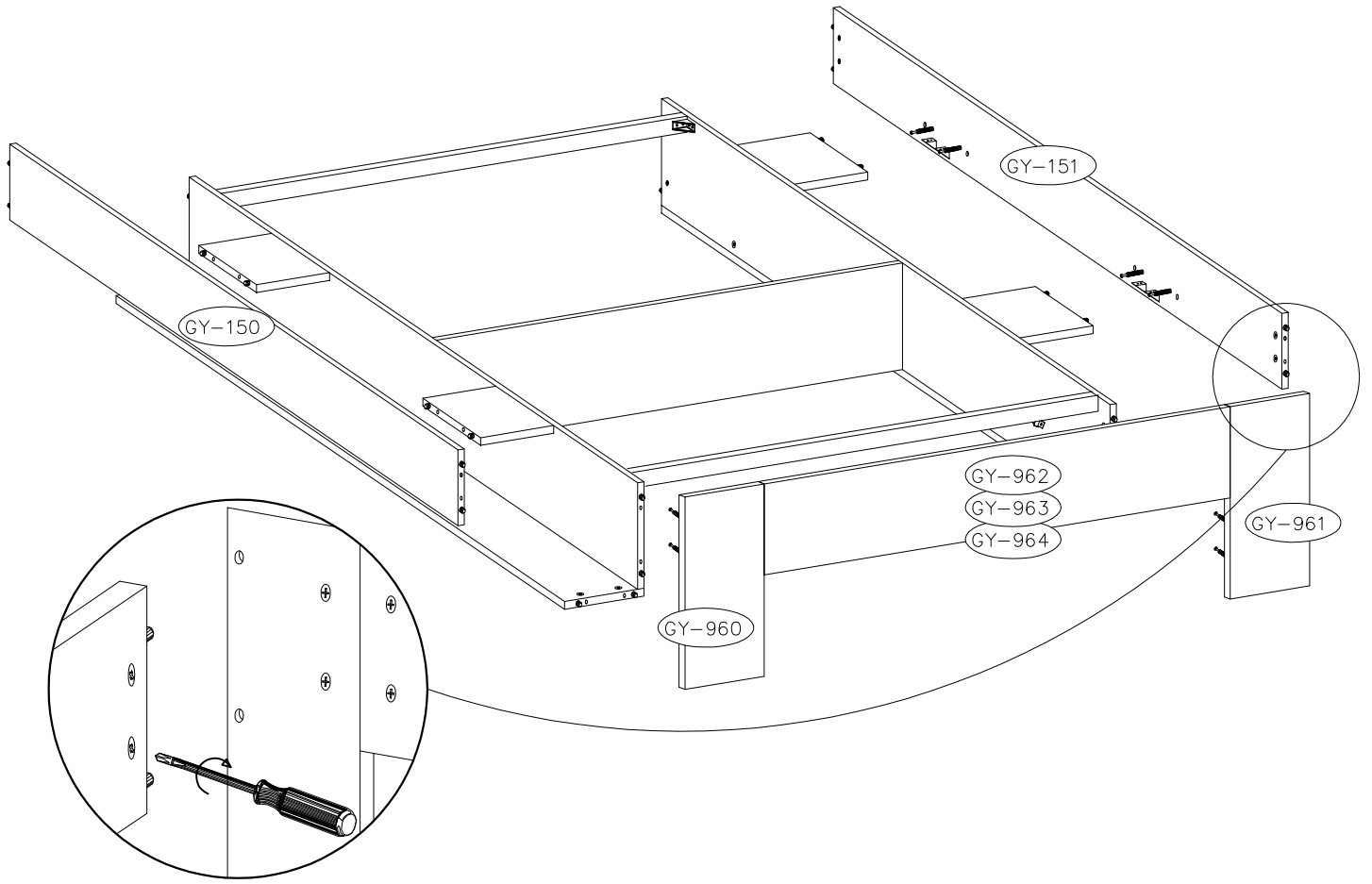

11





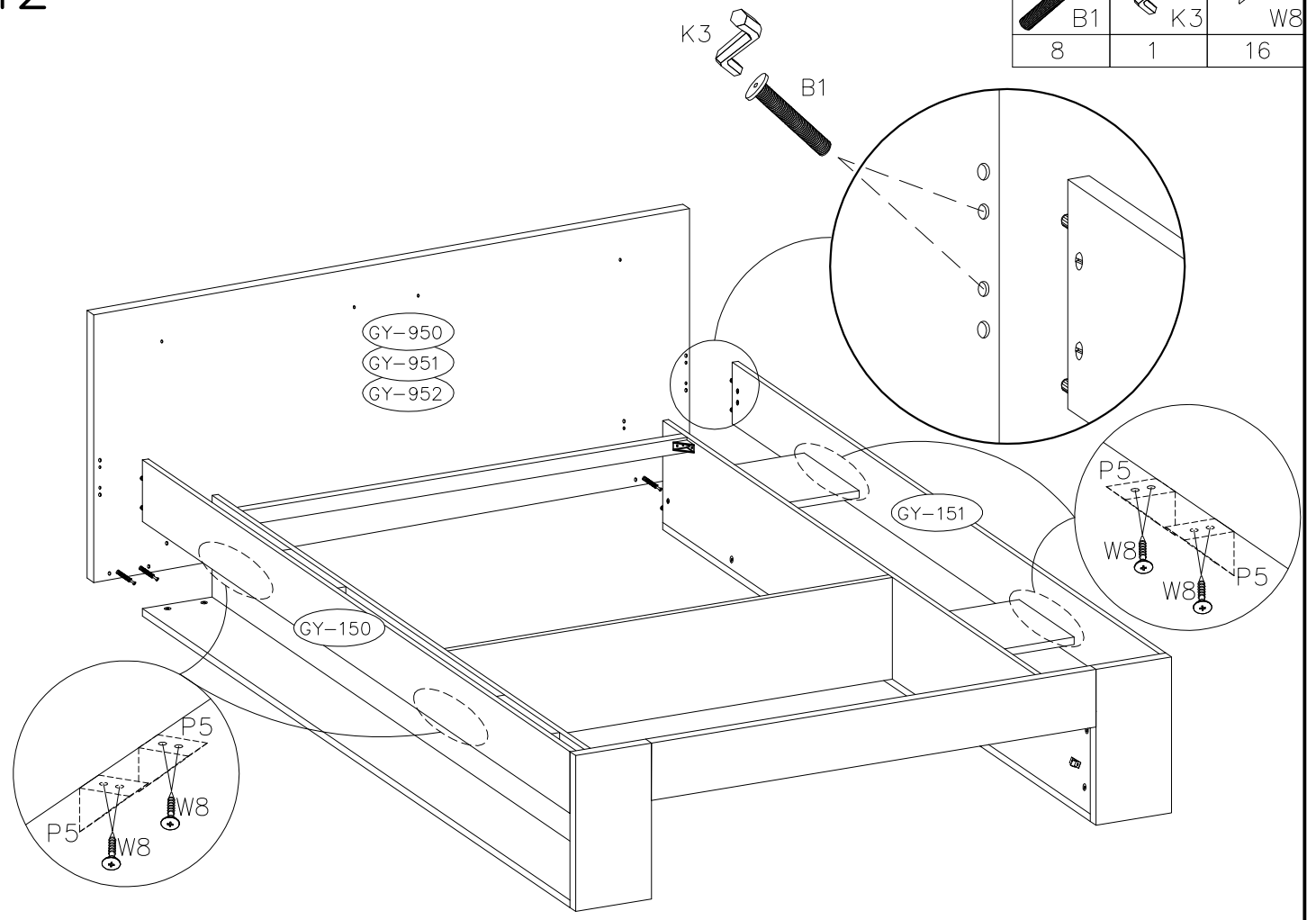

12

M6.0X55	4mm	3.5X13
 B1	 K3	 W8
8	1	16



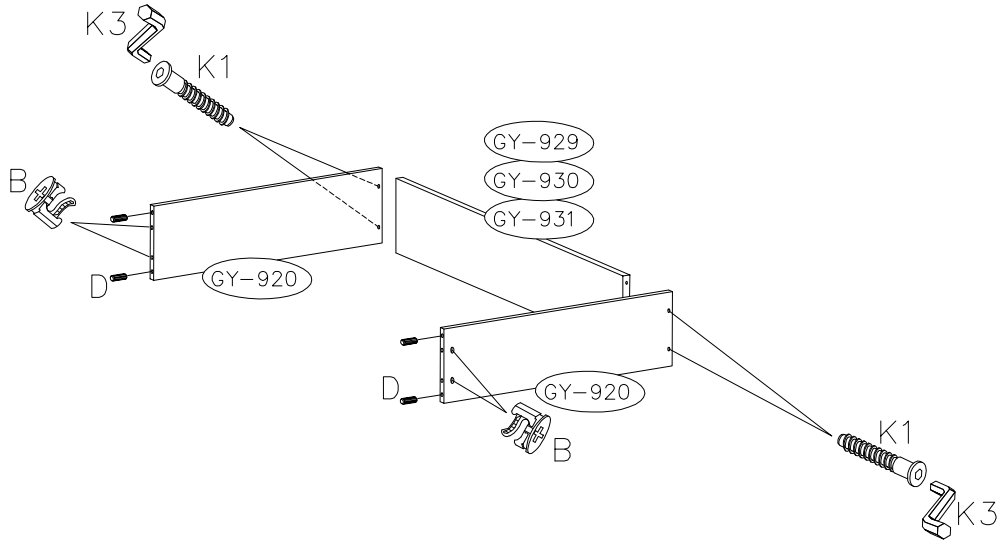

13

	8.0X30 	6.4X50 	4mm 
B	D	K1	K3
4	4	4	1



14

		8.0X30 
A	B	D
7	3	2

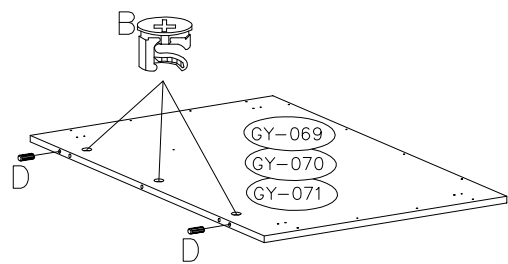
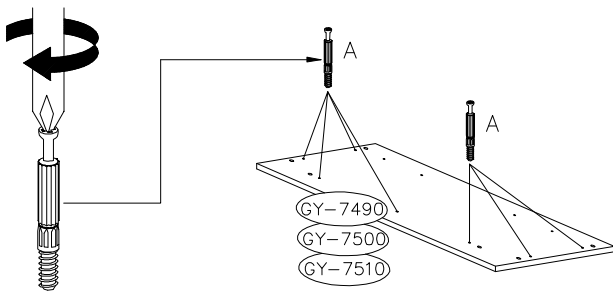

15

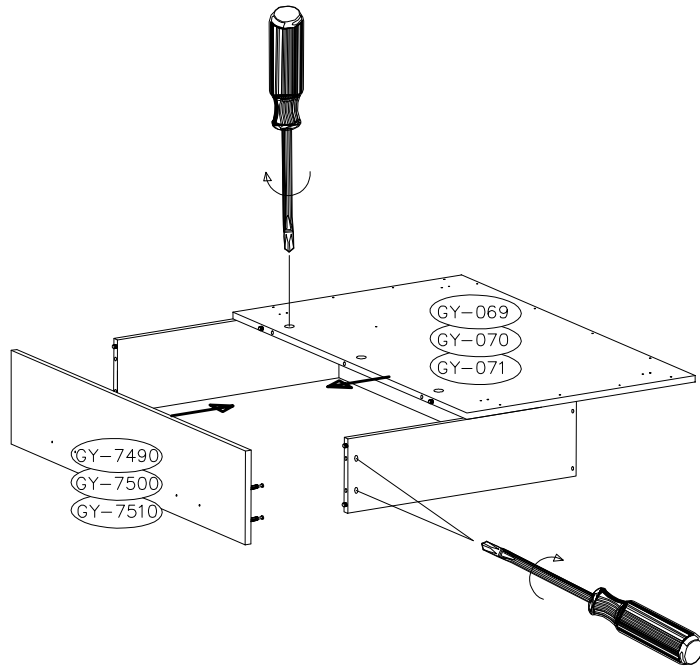

16

3.5X30





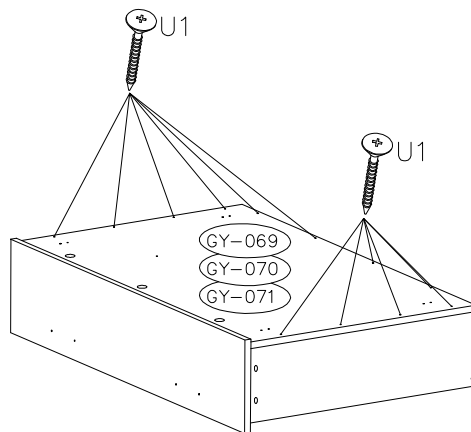

U1

12



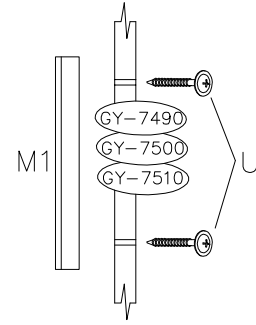
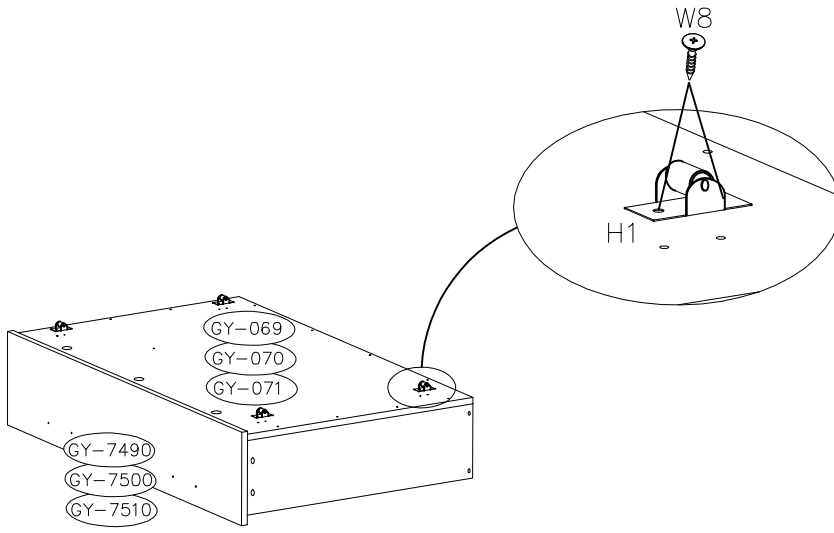

17

3.5X13 	7.404 	4.0X25 	
8	4	4	2



18

4mm 	M6.0X32 	
1	4	8

