

20 min

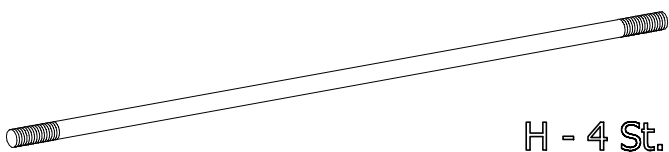

H - 4 St.

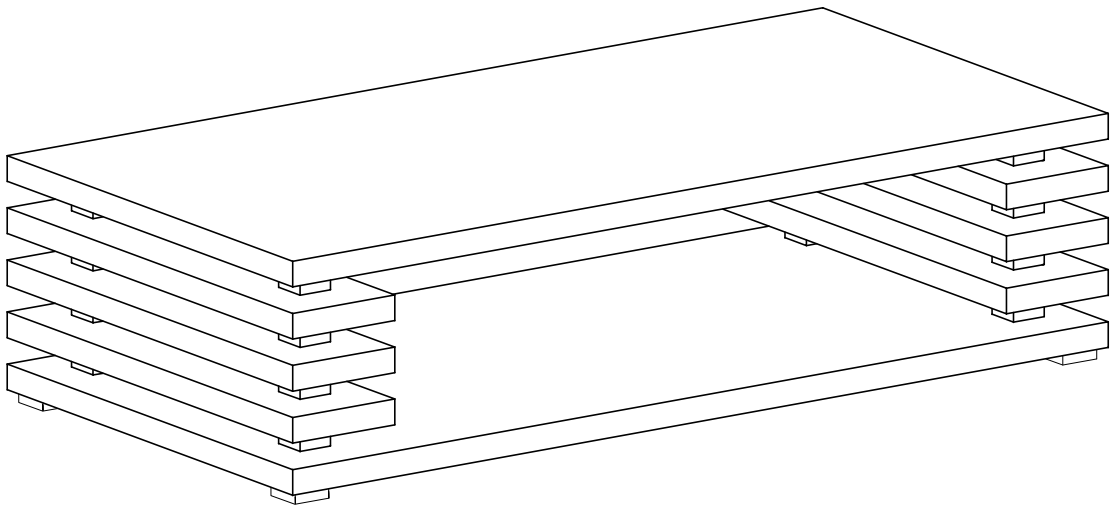
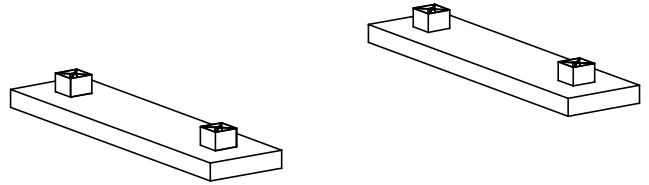
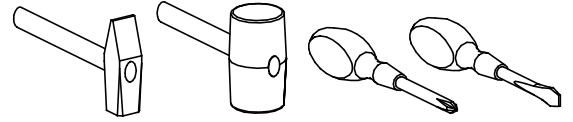
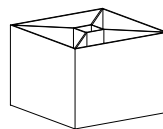

G - 16 St.

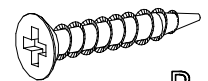

R - 16 St.
4 x 30 mm

16

B - 4 St.

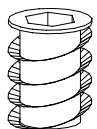

F - 4 St.

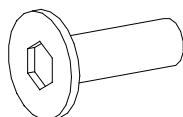

P - 4 St.

