

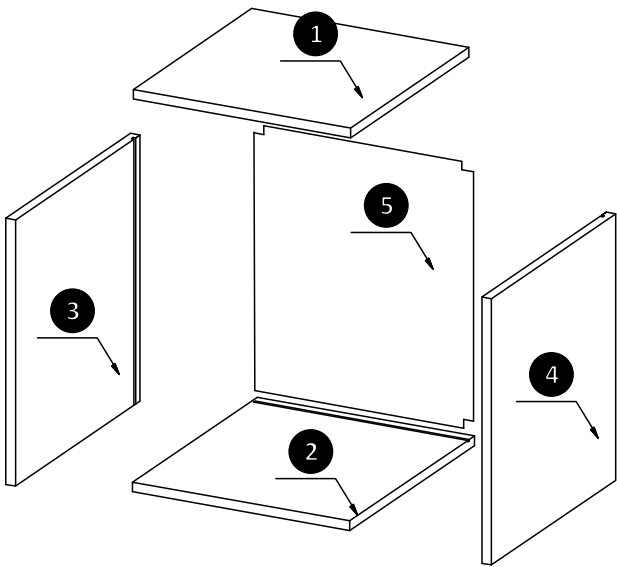

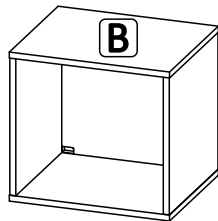

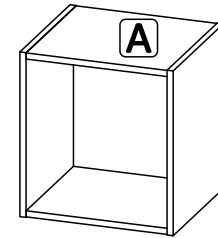



E10



1	1	368	359	16
2	1	368	359	16
3	1	430	360	16
4	1	430	360	16
5	1	406	378	3



A0  8x30 8	C0  8	C2  8	C7  8	D0  3x15 4	D13  4x30 4	M1  4	P4  2
--	---	---	---	---	--	---	---

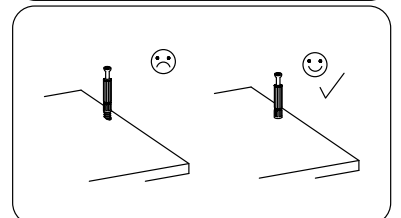
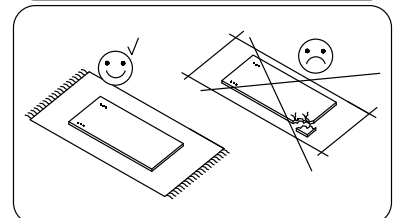
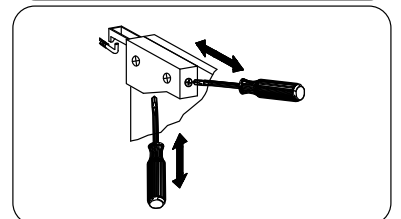
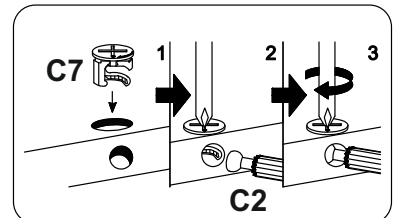
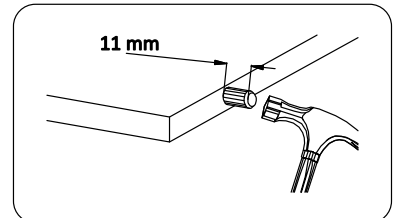
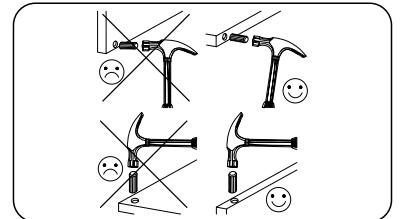
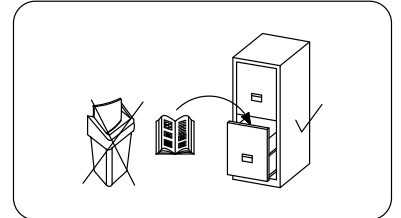
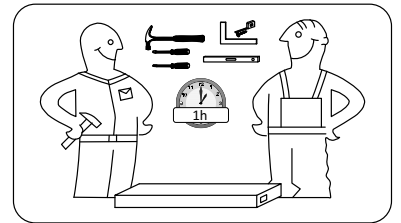

A

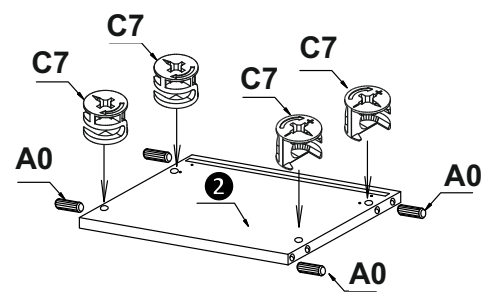
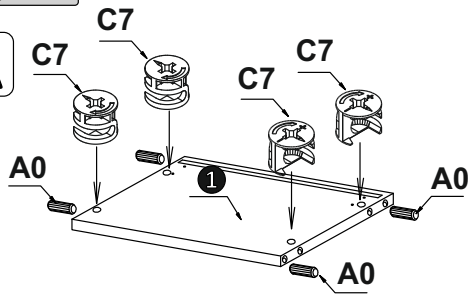

A

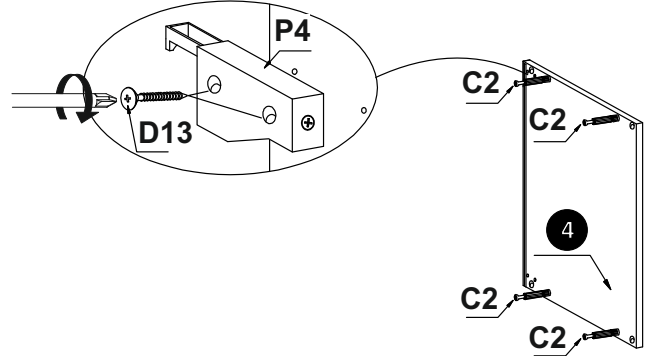
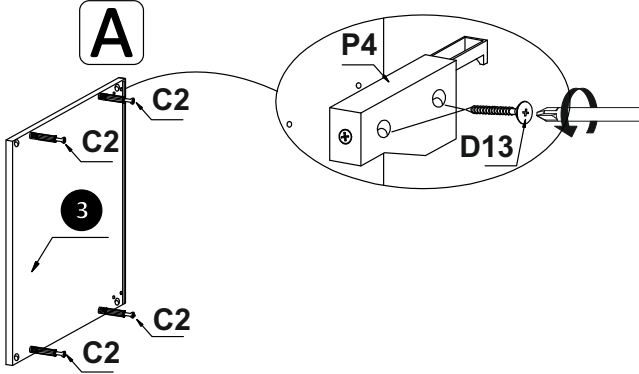

A

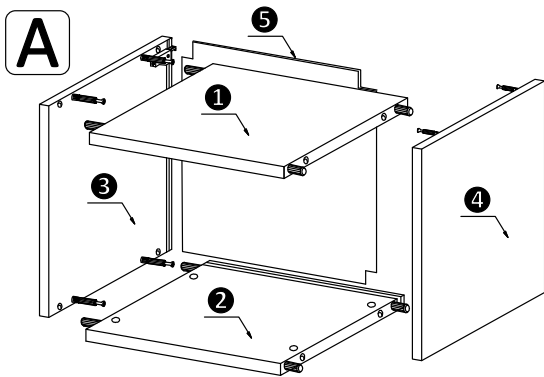

B

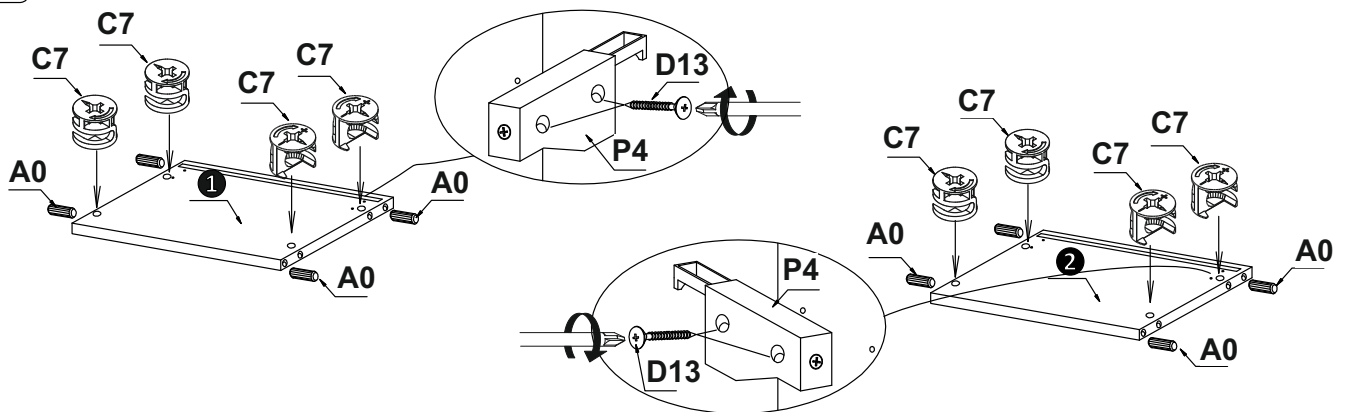

B

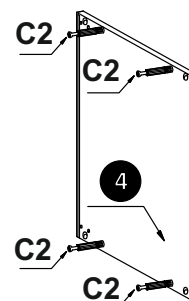
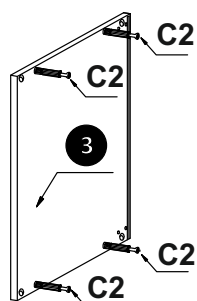

B

