











6,4 x 50mm  B	±7/2mm  J5	 K7	±6,3x9mm  M4	 O	5/45mm  O3	±10x50mm  O7
4	2	2	4	1	2	2

	FLA.305	1100x160x22
1/1	FLA.910	1200x180x16

ISM-FLA-11

1

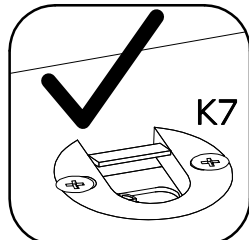
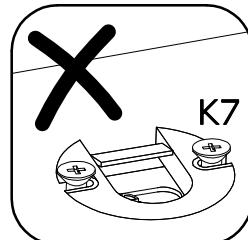
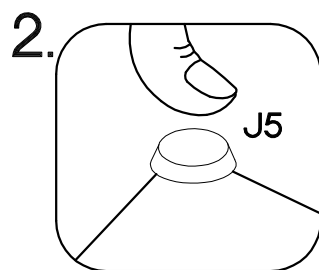
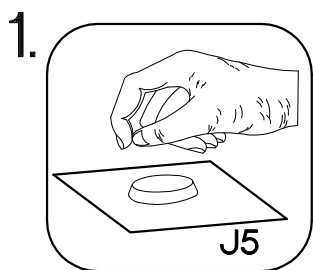
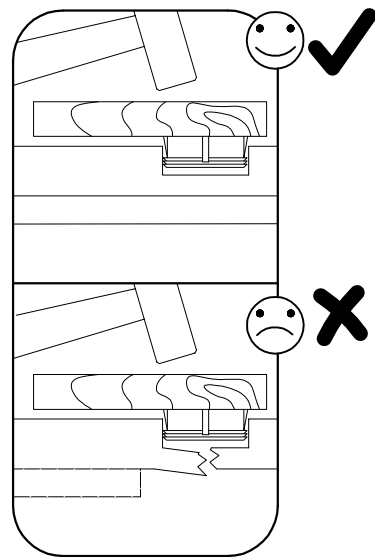
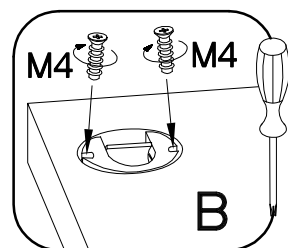
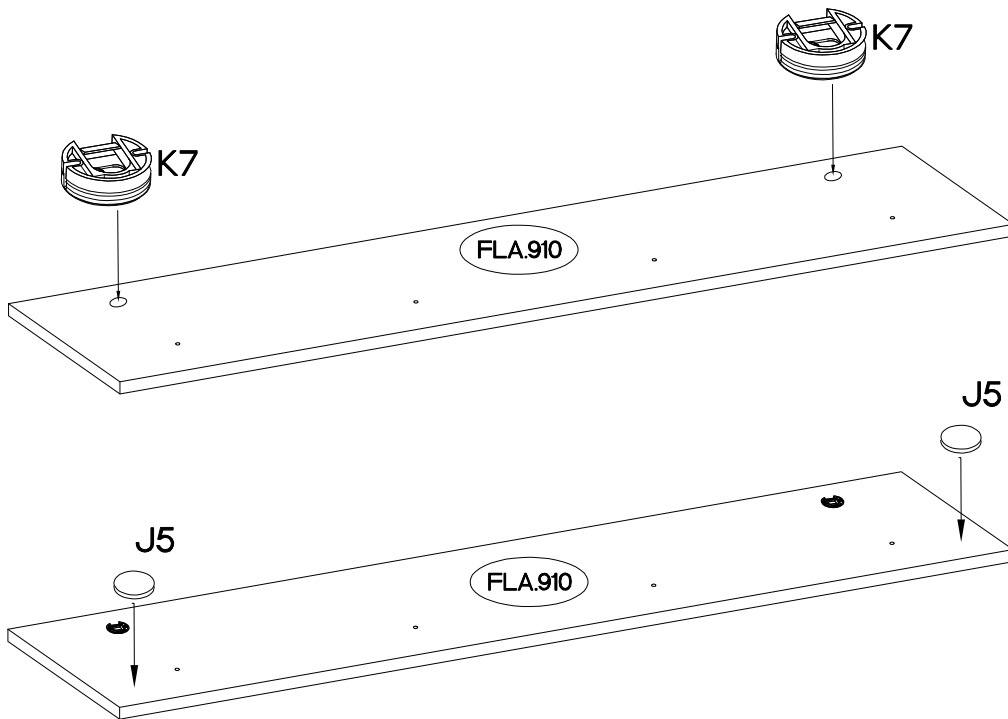
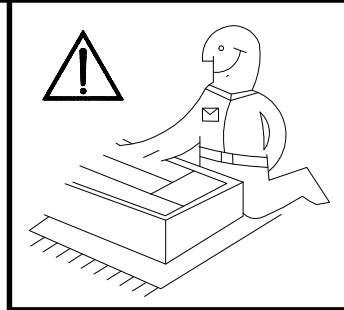
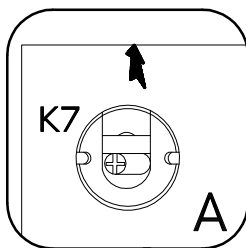

+7/2mm  J5 2	 K7 2	+6,3x9mm  M4 4
---	---	---

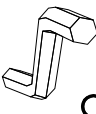
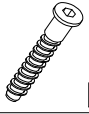

2

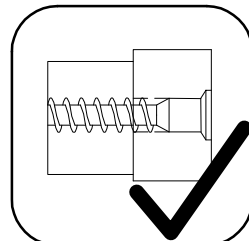
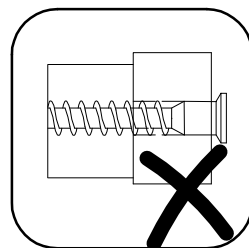
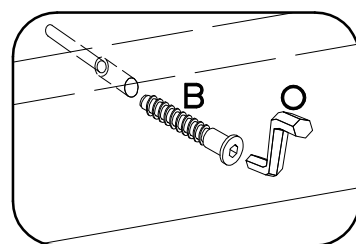
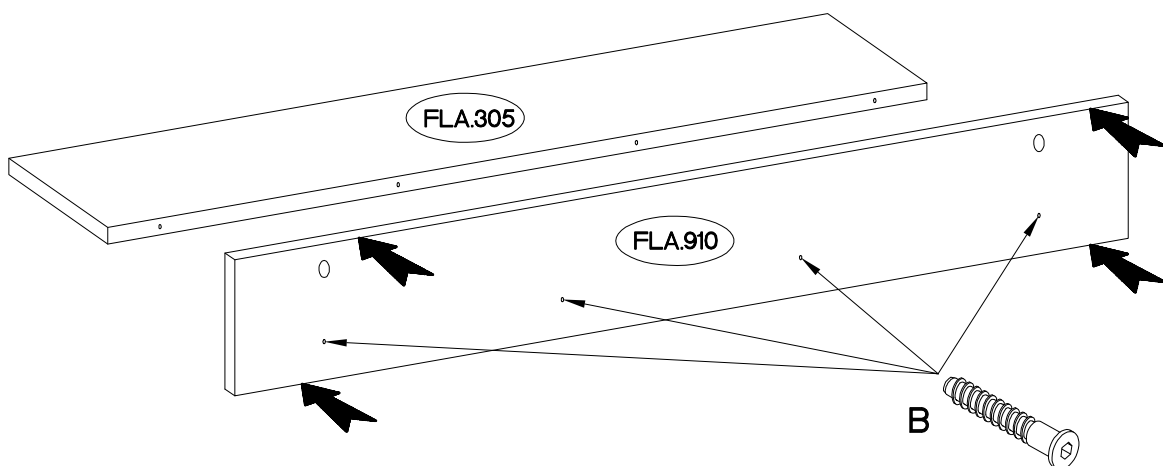
 O 1	6,4 x 50mm  B 4
---	---

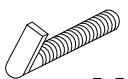

5/45mm	†10x50mm
	
O3	O7
2	2

