

10  
9  
8  
7  
6  
5  
4  
3  
2  
1  
0

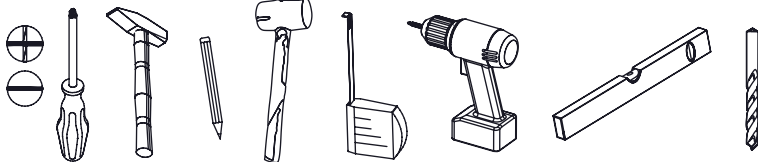

[ 1 ]

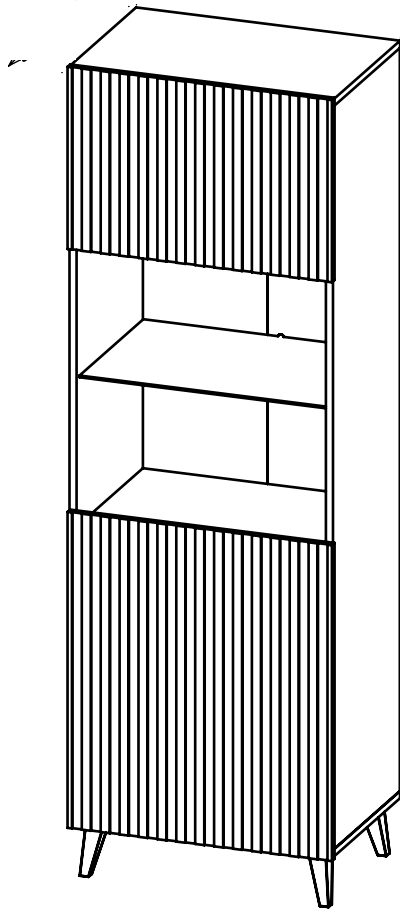
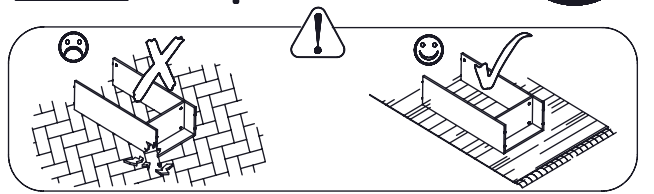

v 1.0

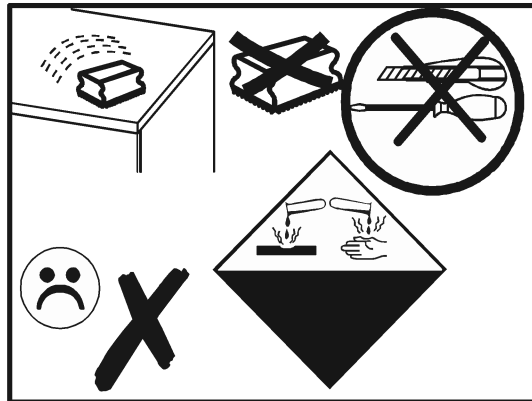
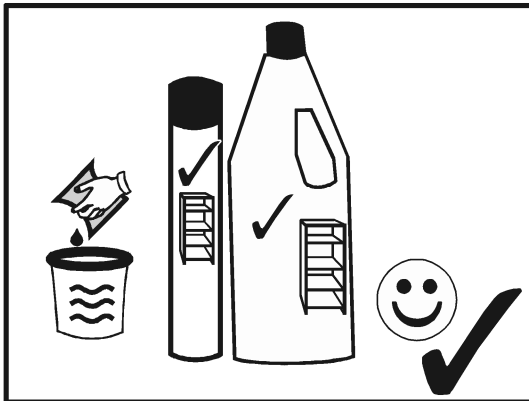
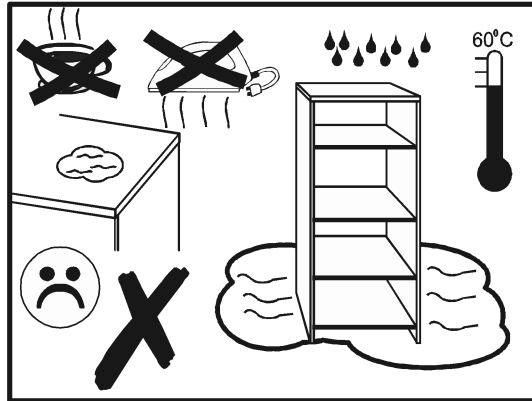
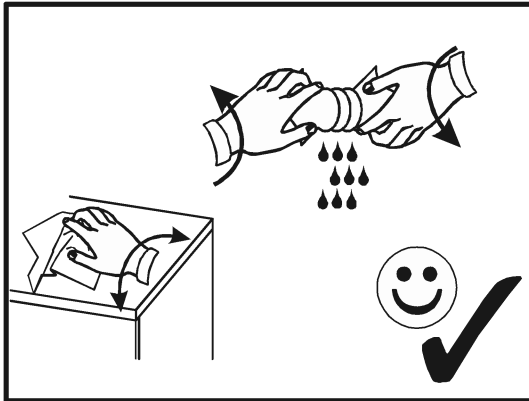
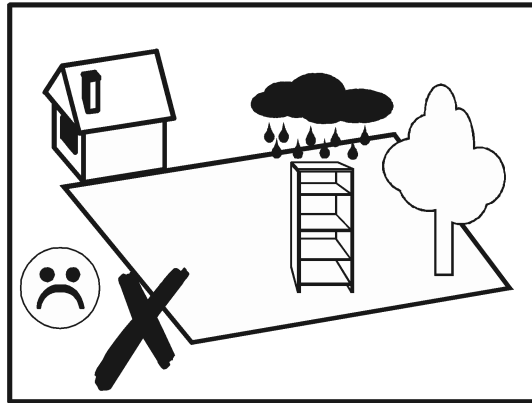
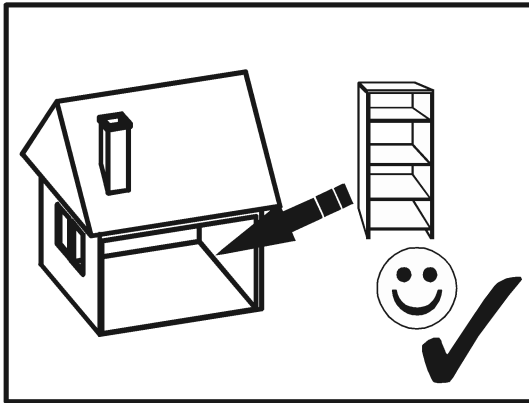

**A**

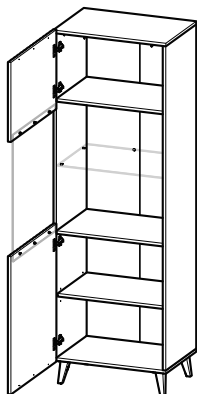



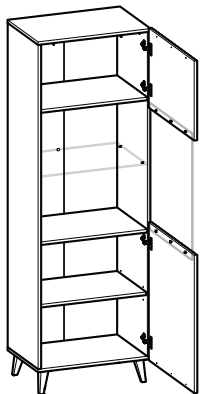



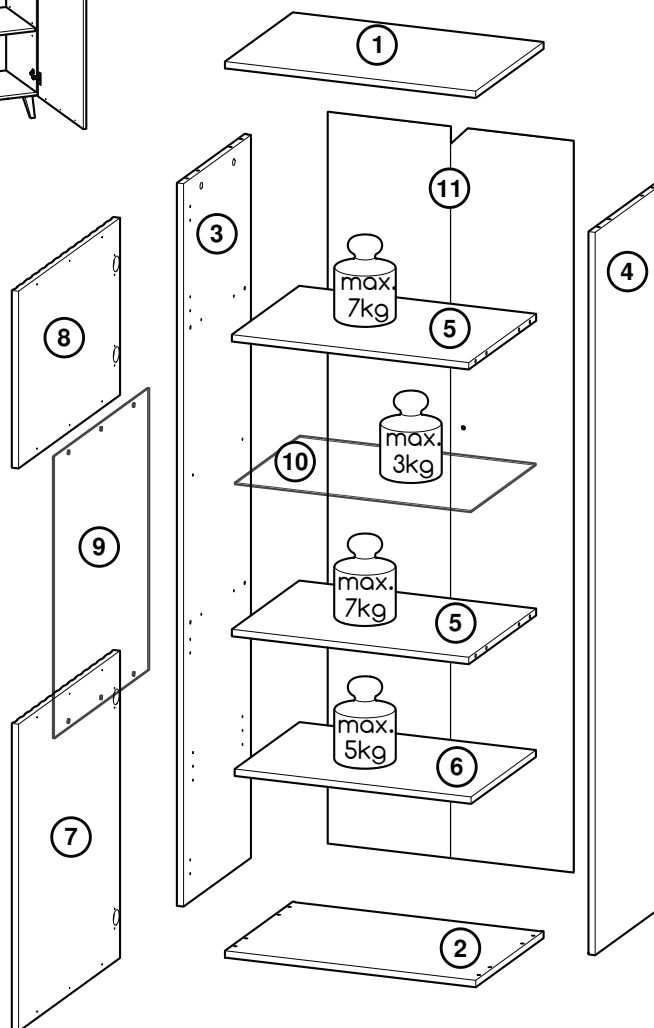



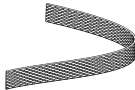





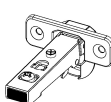

**B**

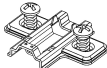

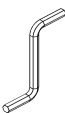
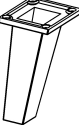
| Nr | Xmm  | Ymm  | Zmm | x |
|----|------|------|-----|---|
| 1  | 597  | 400  | 16  | 1 |
| 2  | 597  | 400  | 16  | 1 |
| 3  | 1668 | 400  | 16  | 1 |
| 4  | 1668 | 400  | 16  | 1 |
| 5  | 564  | 397  | 16  | 2 |
| 6  | 563  | 382  | 16  | 1 |
| 7  | 598  | 709  | 16  | 1 |
| 8  | 598  | 409  | 16  | 1 |
| 9  | 558  | 650  | 4   | 1 |
| 10 | 562  | 382  | 4   | 1 |
| 11 | 585  | 1688 | 2,5 | 1 |



|   |  |  |   |   |   |
|---|--|--|---|---|---|
| <b>S26</b><br><br>2x<br>Ø6/16  | <b>G37</b><br><br>1x<br>Ø4x13 | <b>G17</b><br><br>1x<br>4x45    | <b>J24</b><br><br>1x<br>L150  | <b>U6</b><br><br>1x<br>Ø8x40 | <b>A1</b><br><br>4x<br>Ø7x50 |
| <b>K1</b><br><br>12x<br>Ø15x12 | <b>K5</b><br><br>12x<br>34mm  | <b>I20</b><br><br>12x<br>Ø4/Ø17 | <b>B1</b><br><br>16x<br>Ø8x35 | <b>F2</b><br><br>4x<br>Ø5    | <b>I18</b><br><br>1x<br>Ø14  |
| <b>C3</b><br><br>4x<br>SOFT    | <b>G5</b><br><br>8x<br>4x13   | <b>D3</b><br><br>4x<br>SOFT     | <b>W4</b><br><br>64x           | <b>W2</b><br><br>1x<br>4mm   | <b>P46</b><br><br>4x<br>h120 |
| <b>G11</b><br><br>16x<br>4x20  | <b>F11</b><br><br>4x<br>Ø5    | <b>I3</b><br><br>6x             | <b>G50</b><br><br>6x<br>3,5x16 |   |   |

I

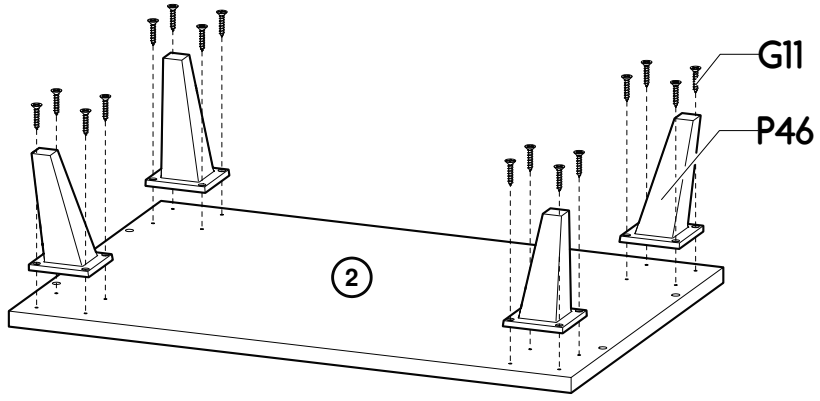

II

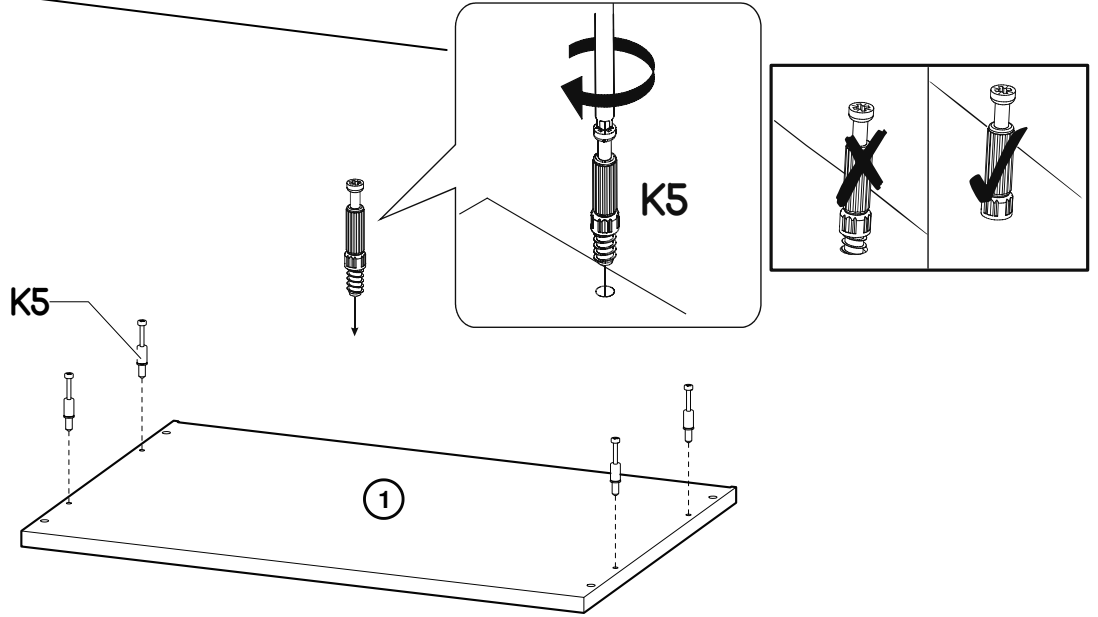

III

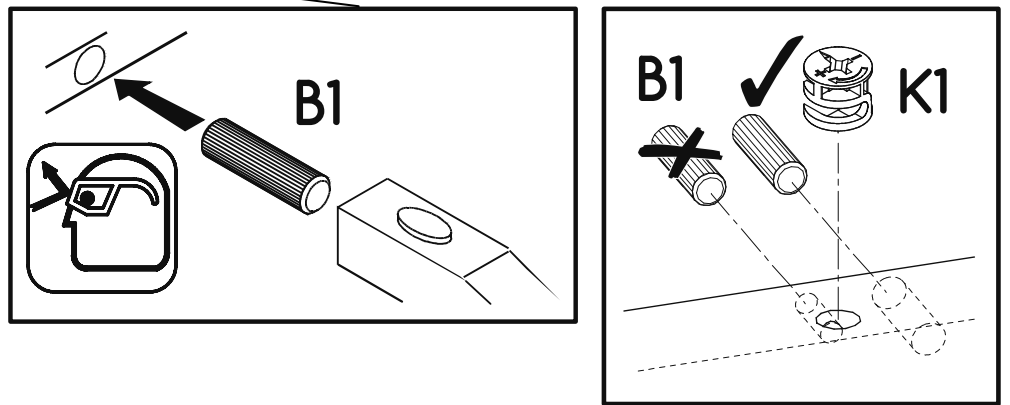

x2

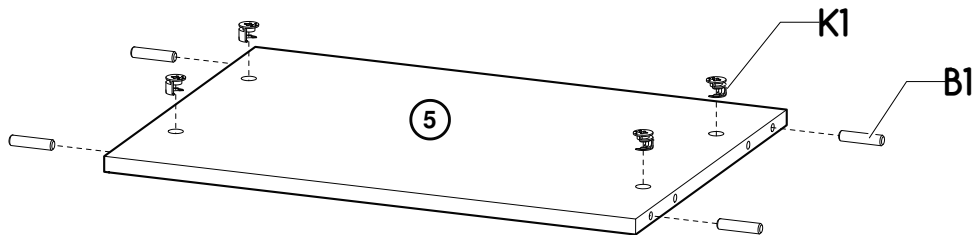

IV

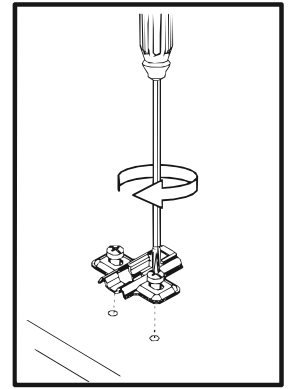
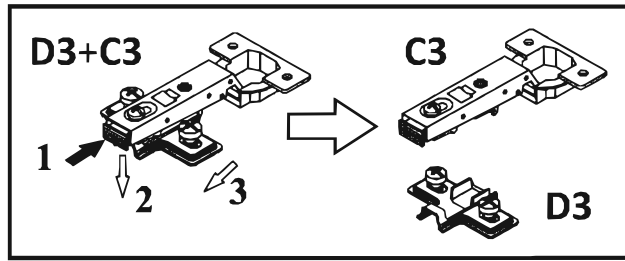

A

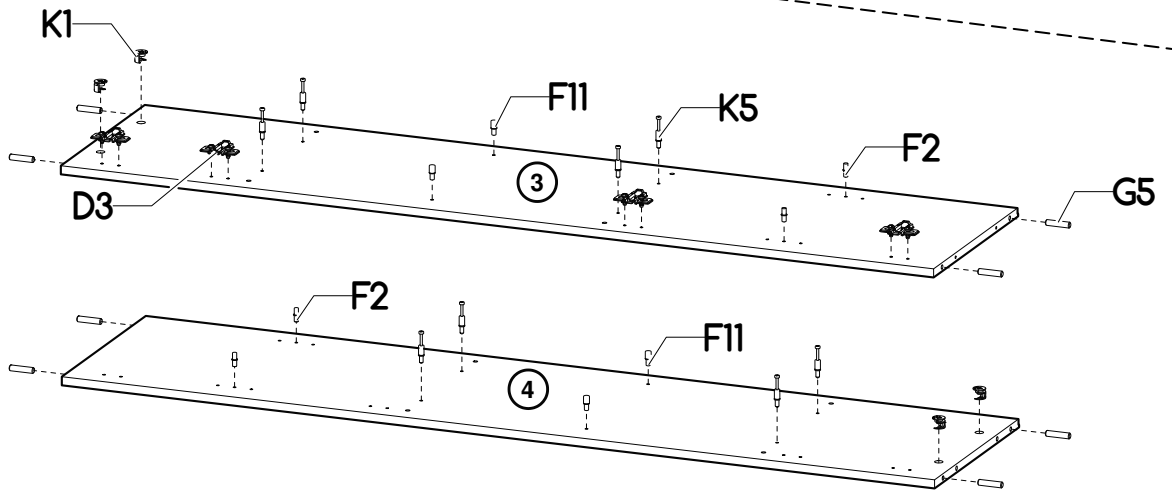
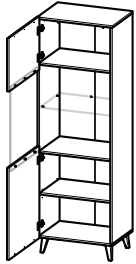

B

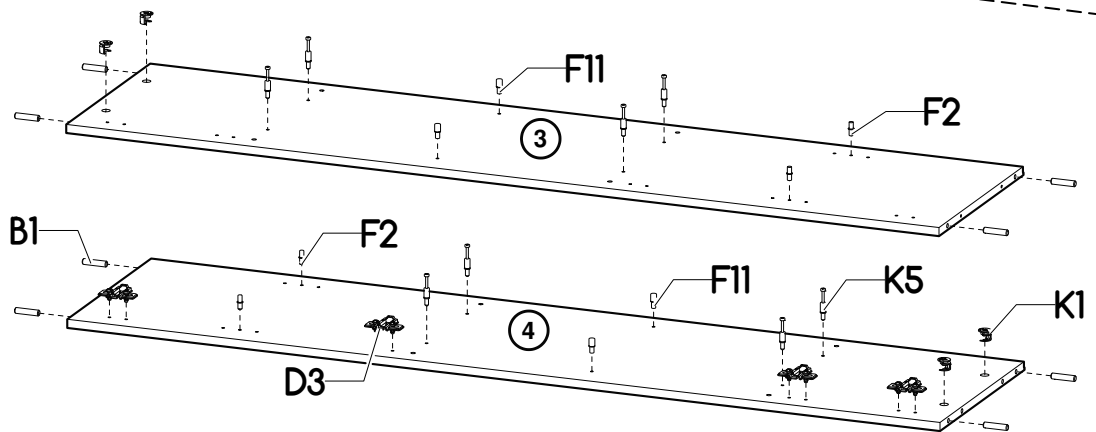

V

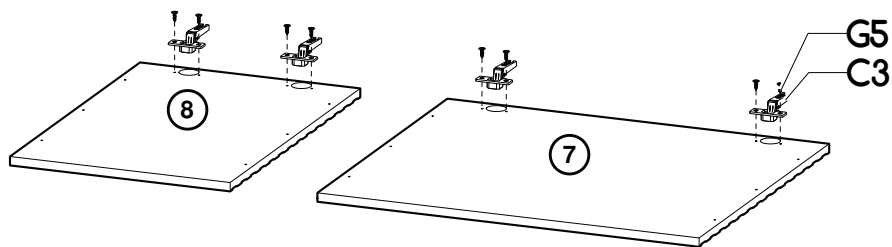

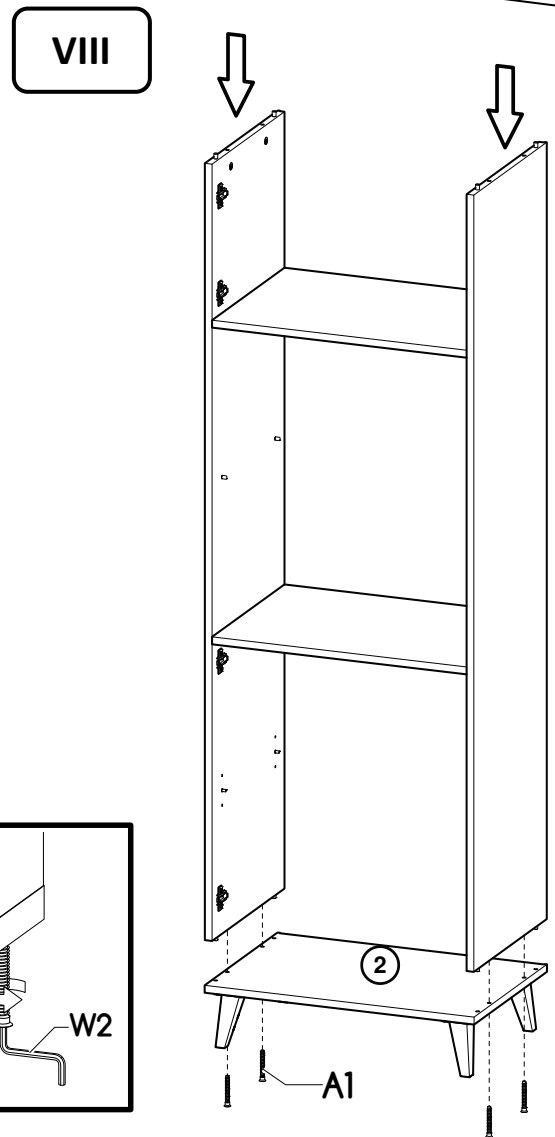
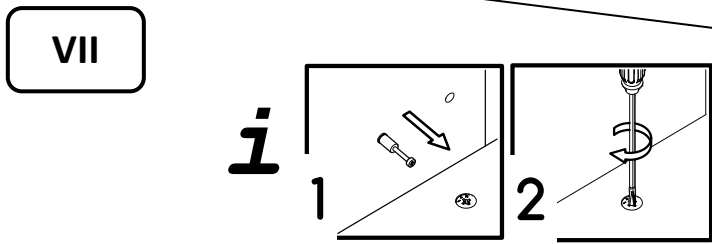
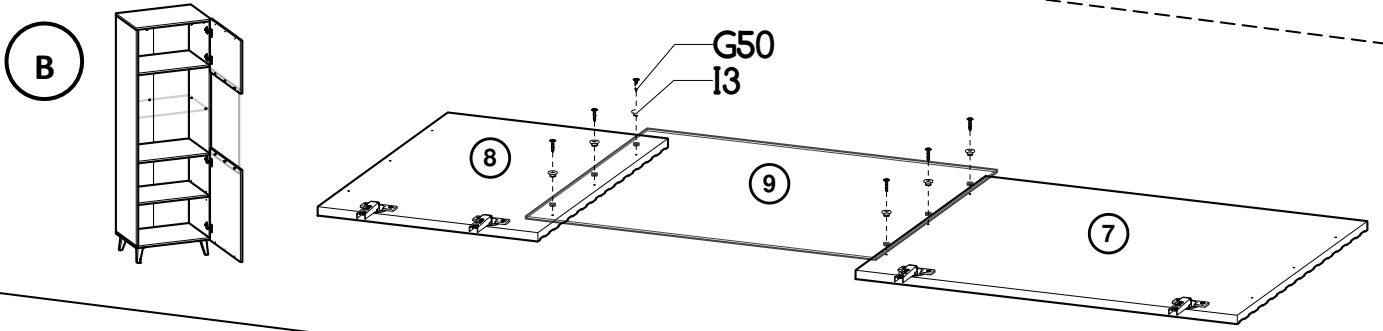
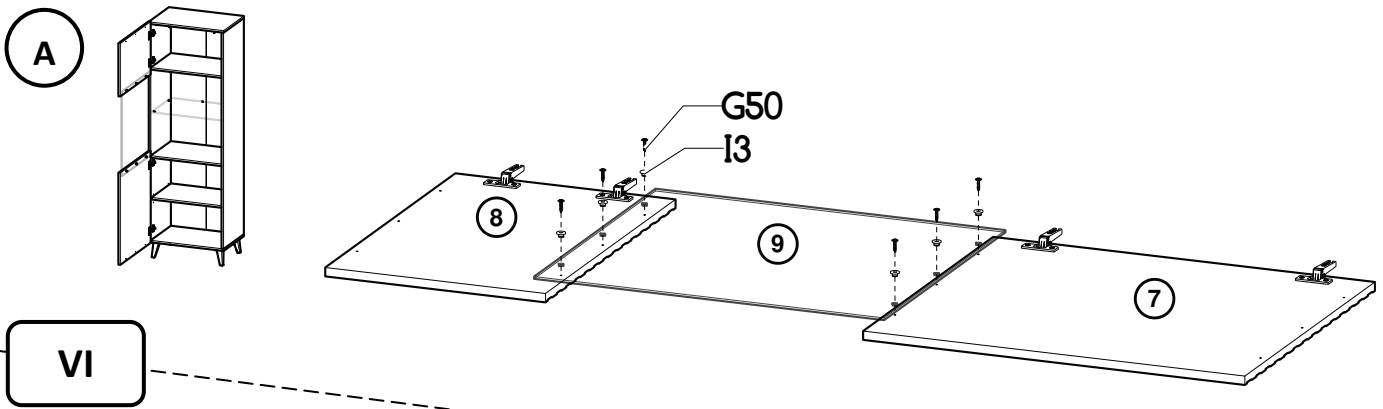

IX

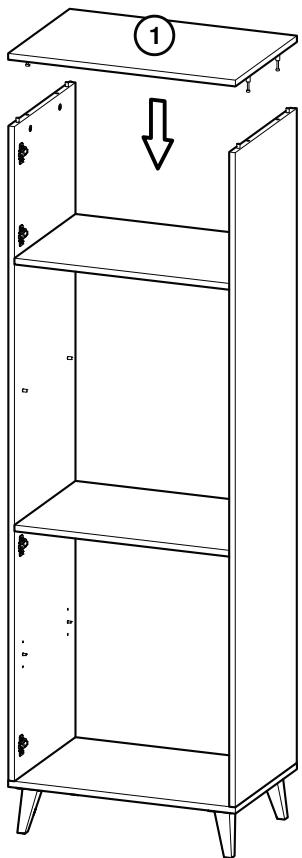

X

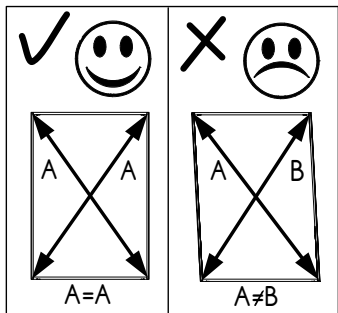
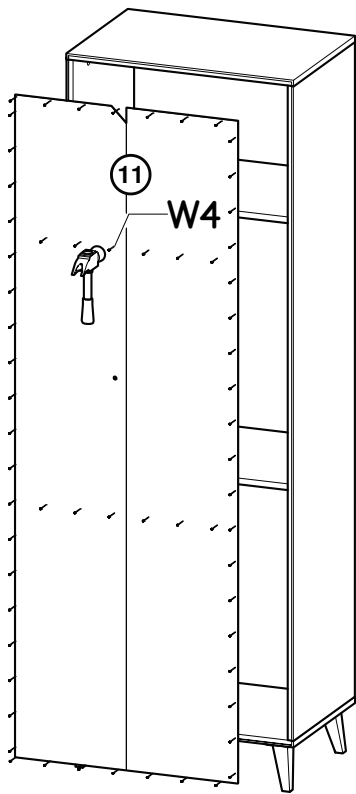

XI

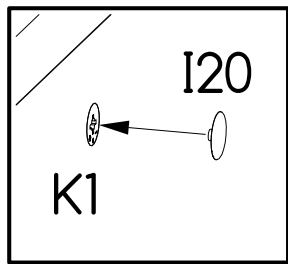
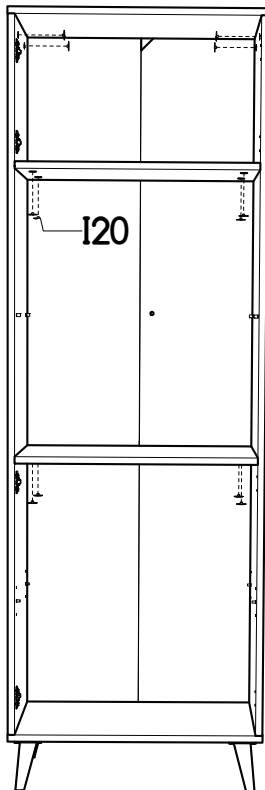

XII

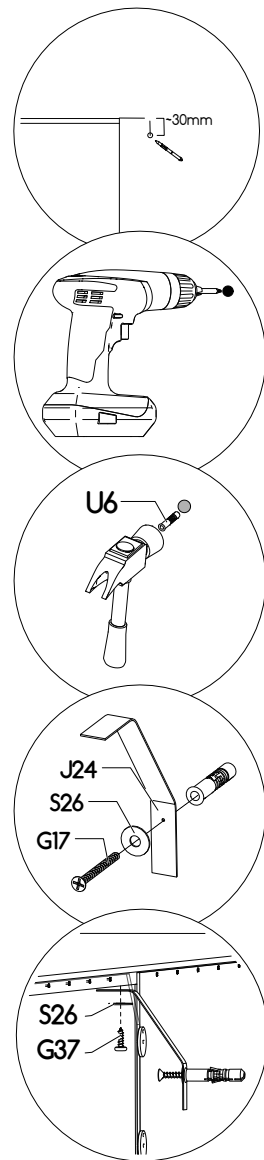
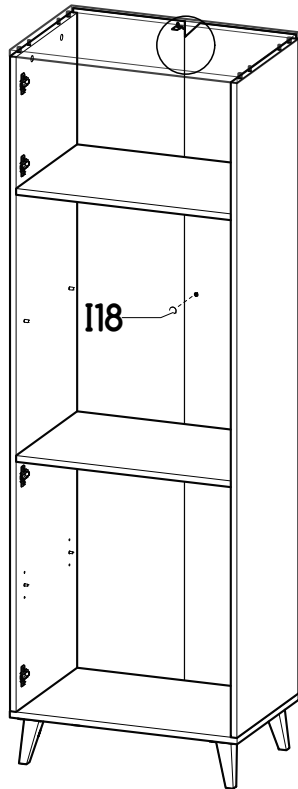

XIII

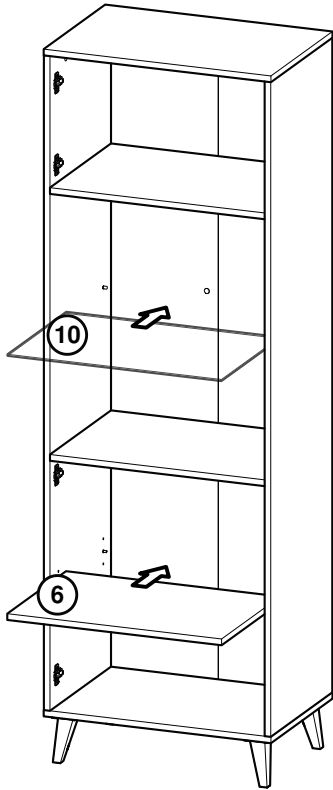

XIV

A

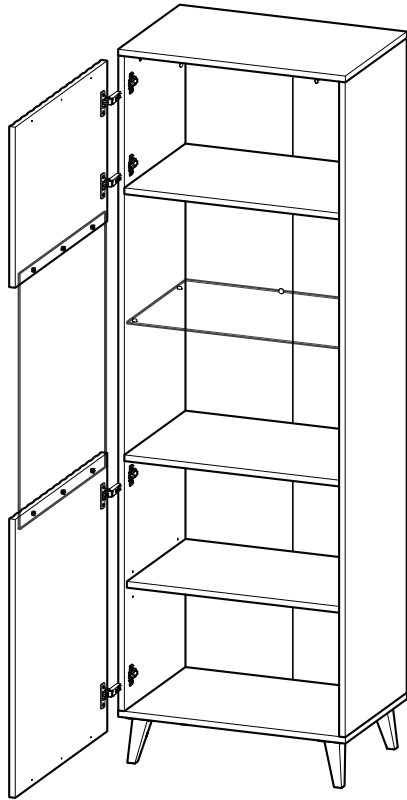

B

