

 †10x50mm O7 2	 †5.0x70mm P29 2	 †20 E11 2	 †8x30mm A 20	 6,4 x 50mm B 24	 †5/18mm C6 10	 L=20mm D2 10	 E 10	 60x40x20 F1 4	 †4.0x25mm P14 8	 O 1
---------------------------------------	---	-----------------------------------	--------------------------------------	---	---------------------------------------	--------------------------------------	--------------------	---------------------------------------	---	-------------------

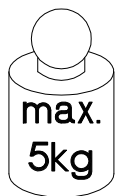

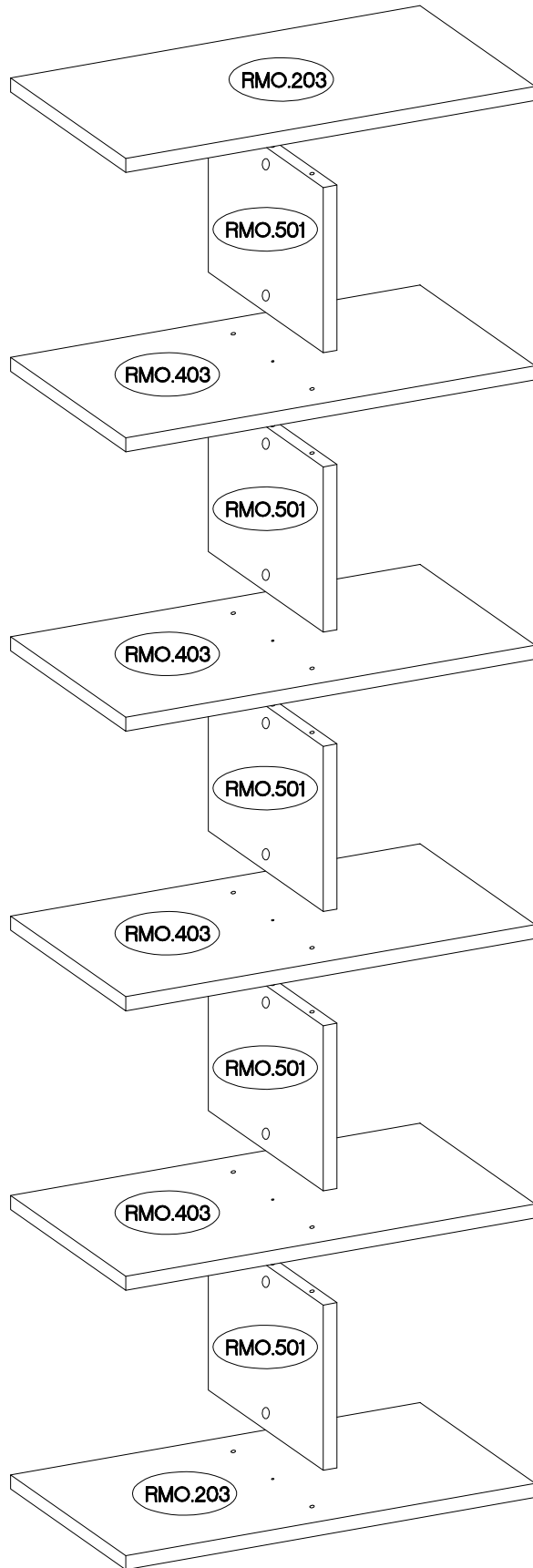

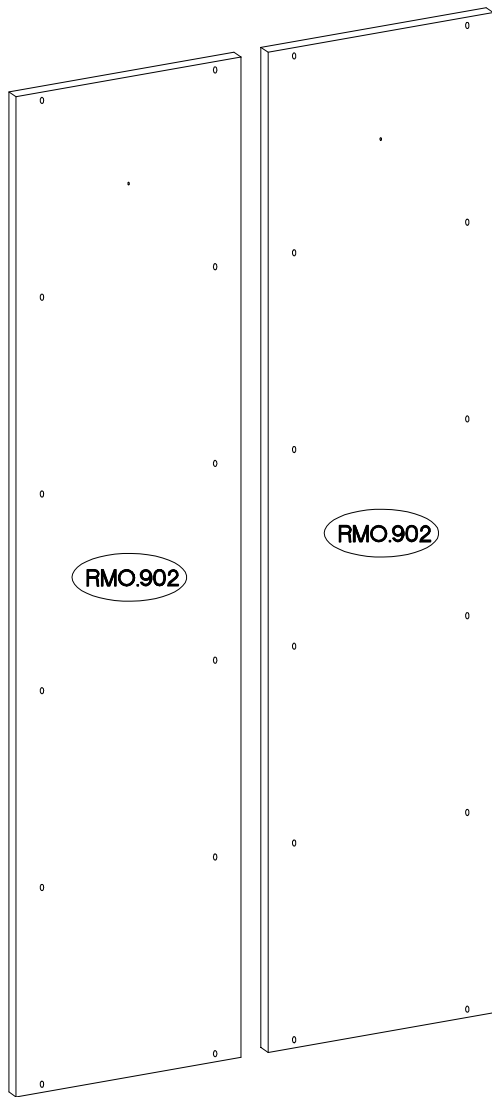

MSN.203

MSN.403

RMO.203	830x281x28
RMO.403 x 4	830x281x28
RMO.501 x 2	330x280x28
RMO.203	830x281x28
RMO.501 x 3	330x280x28
RMO.902 x 2	1820x416x16

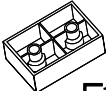
1

+8x30mm  A	+15/18mm  C6	L=20mm  D2	60x40x20  F1	+4.0x25mm  P14
20	10	10	4	8

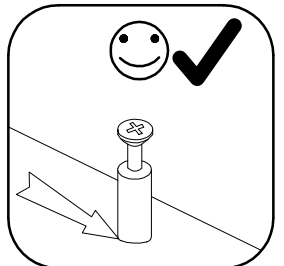
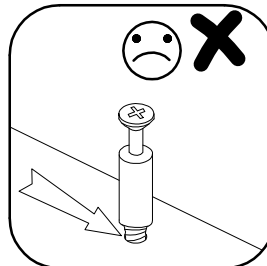
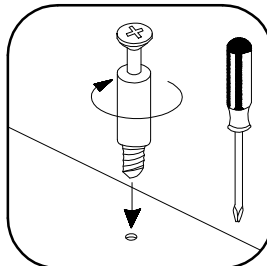
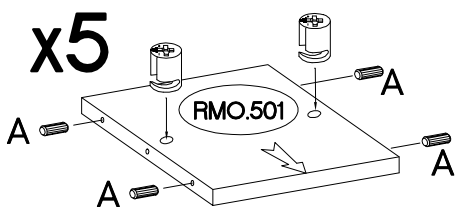
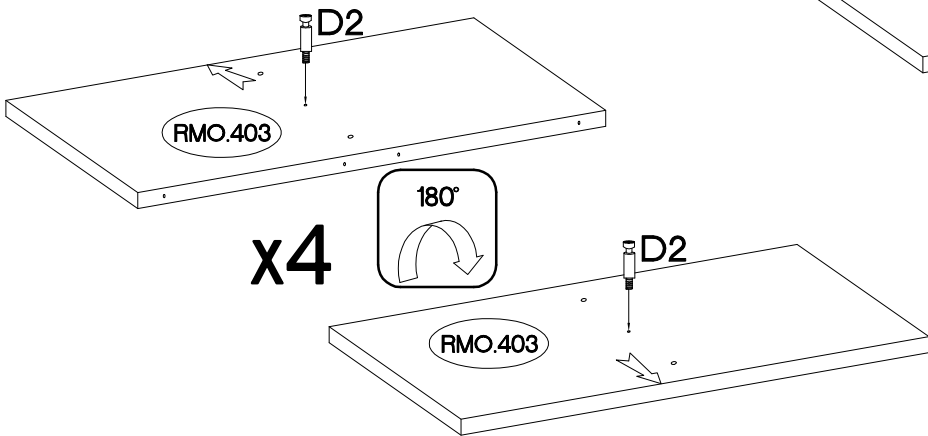
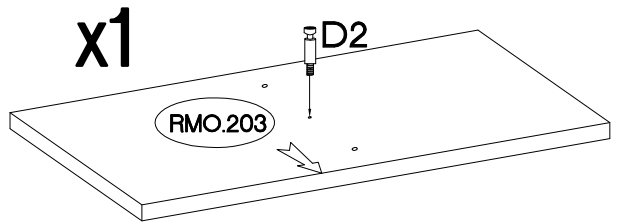
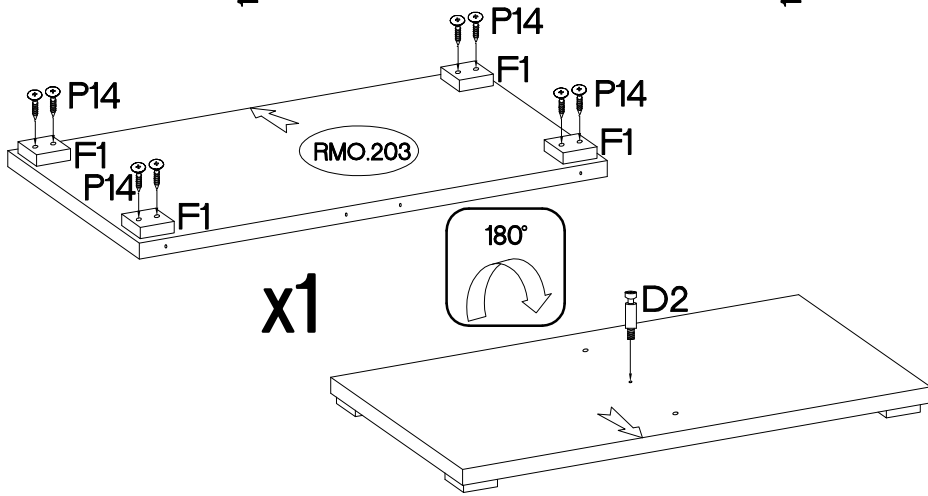
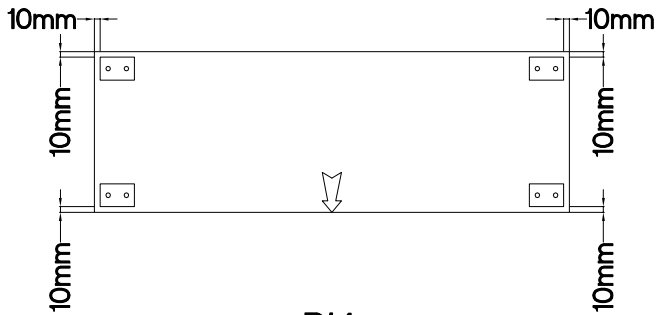
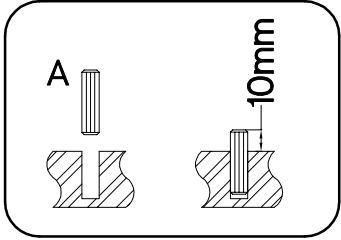
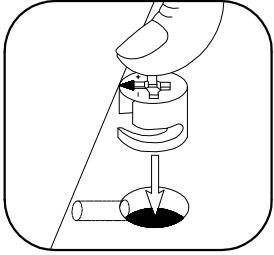
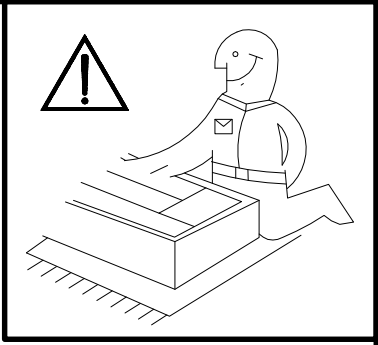

2

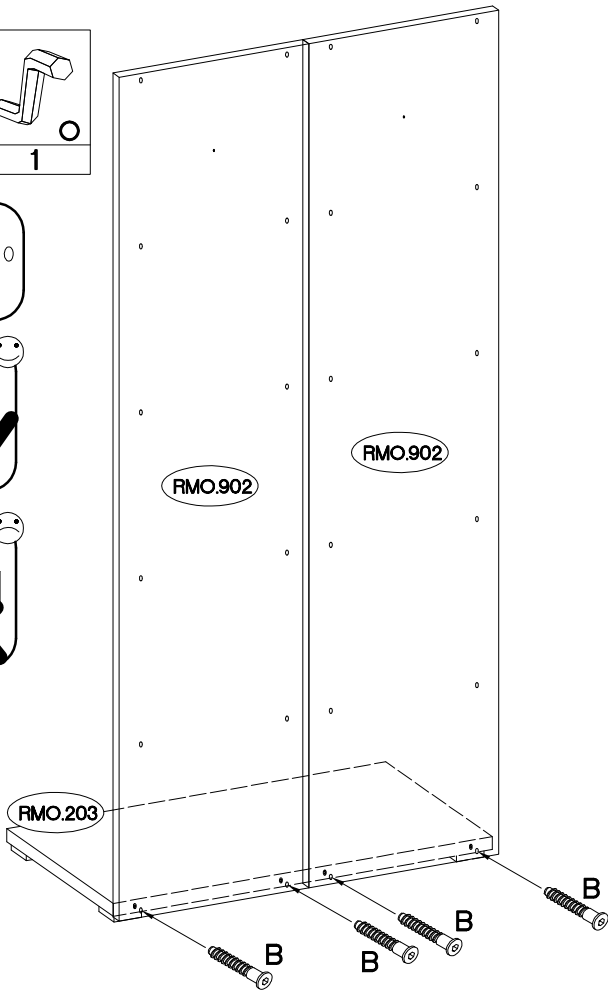
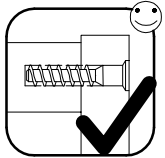
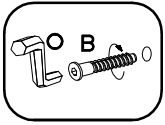
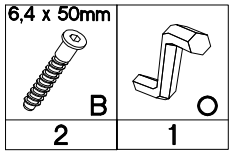

3

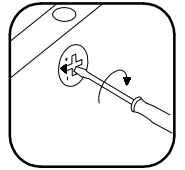
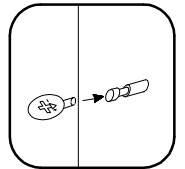
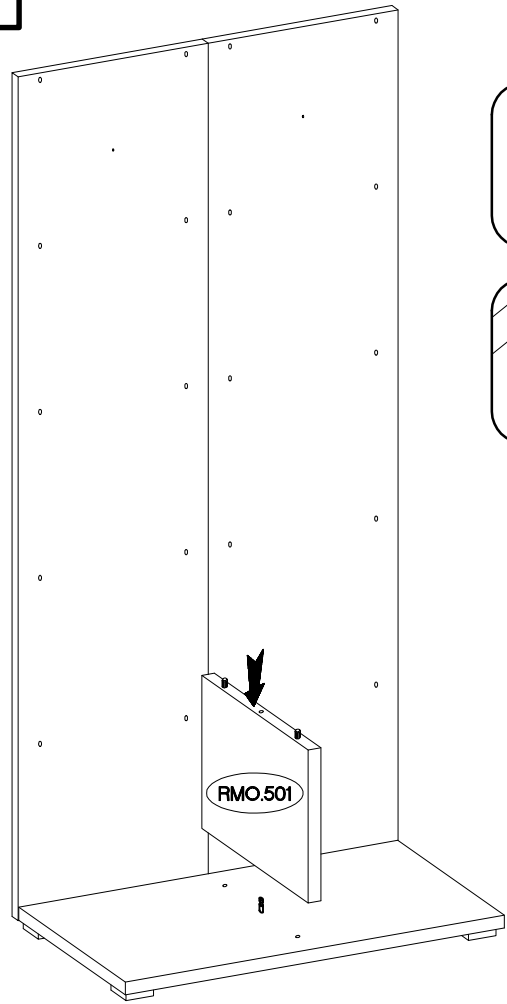

4

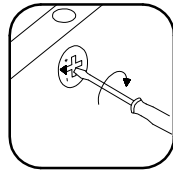
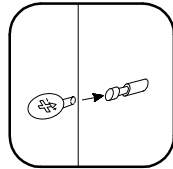
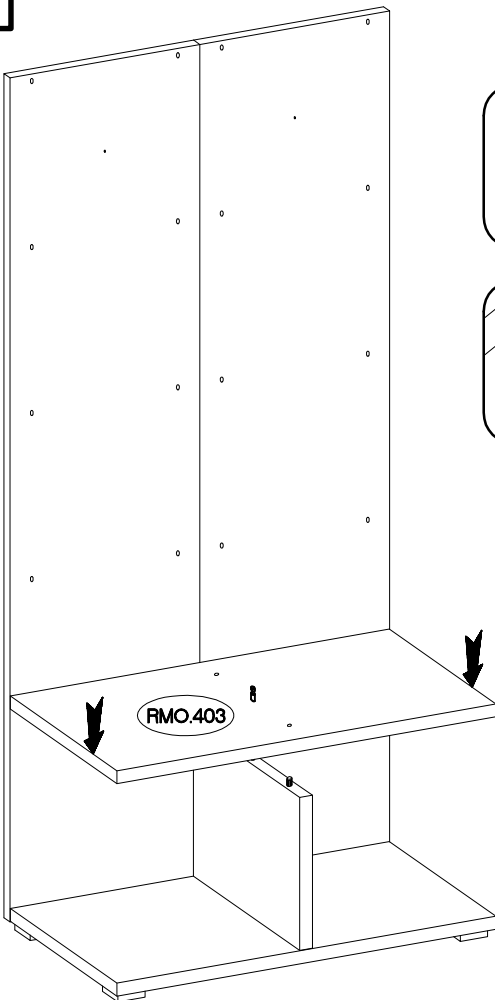

5

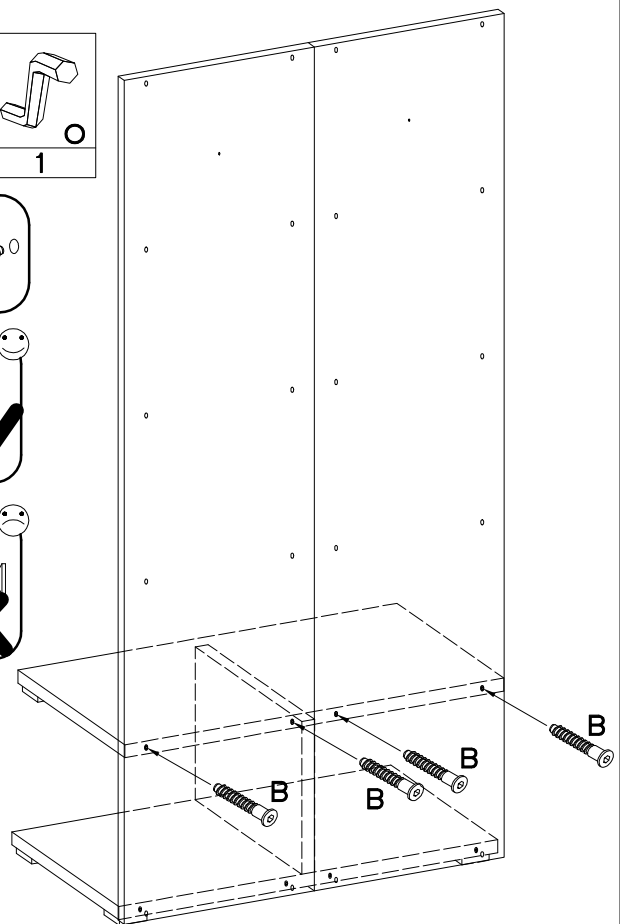
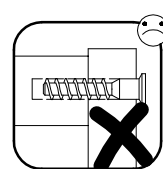
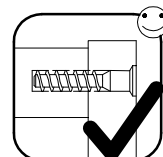
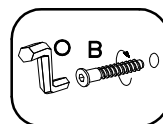
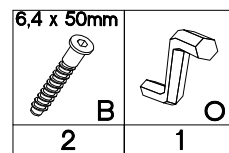

6

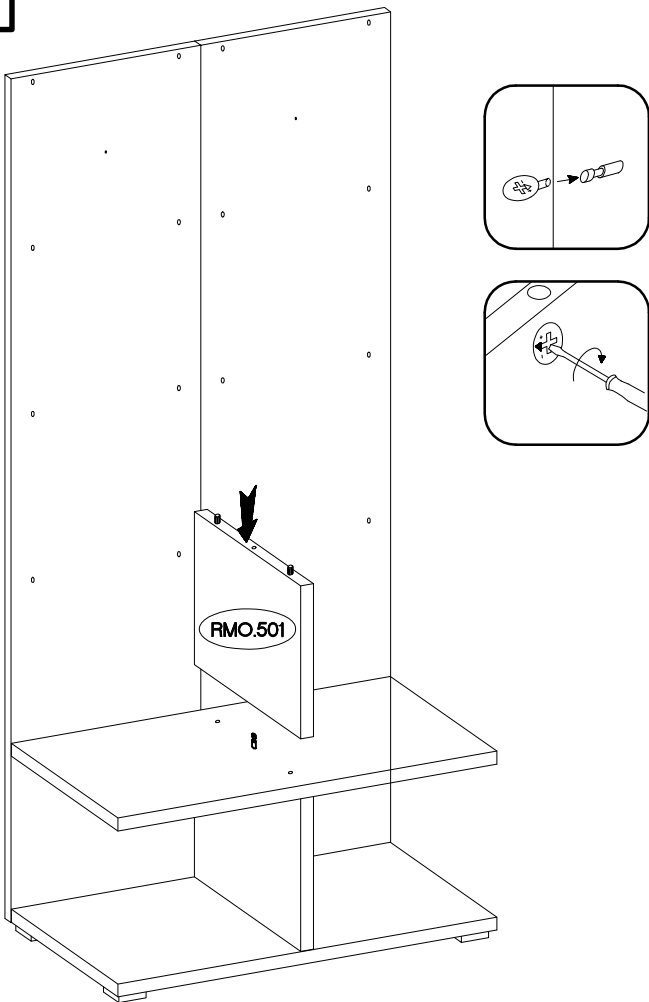

7

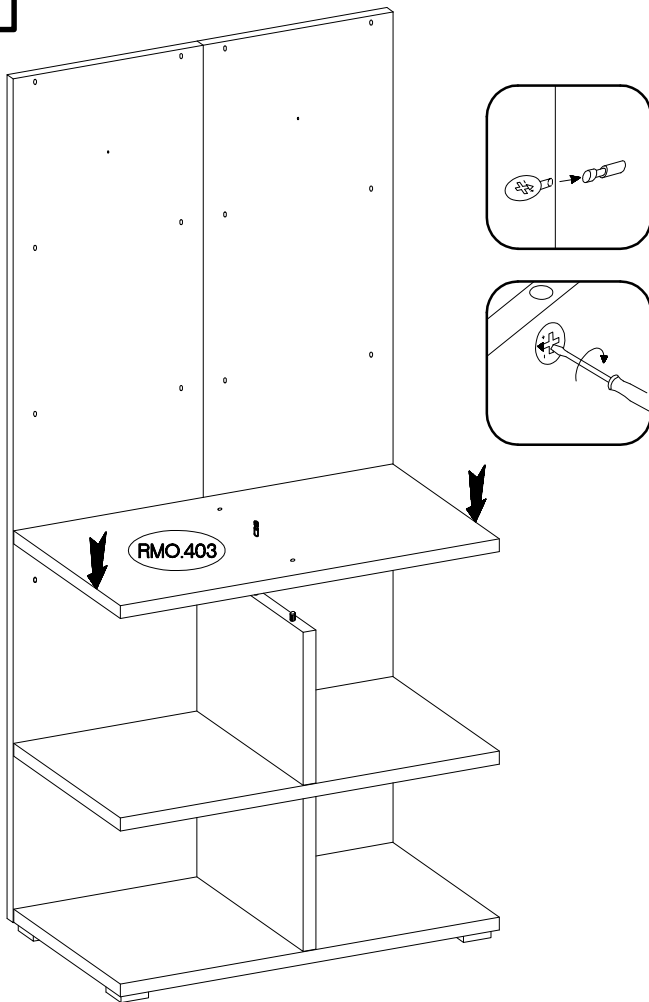

8

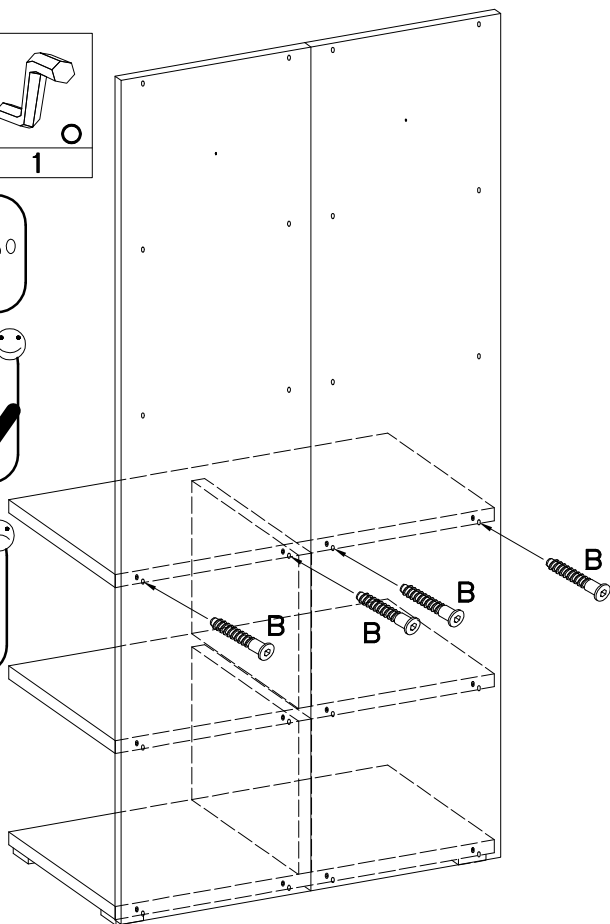
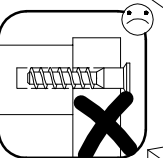
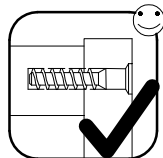
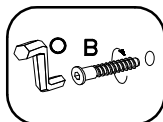
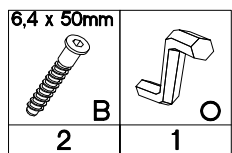

9

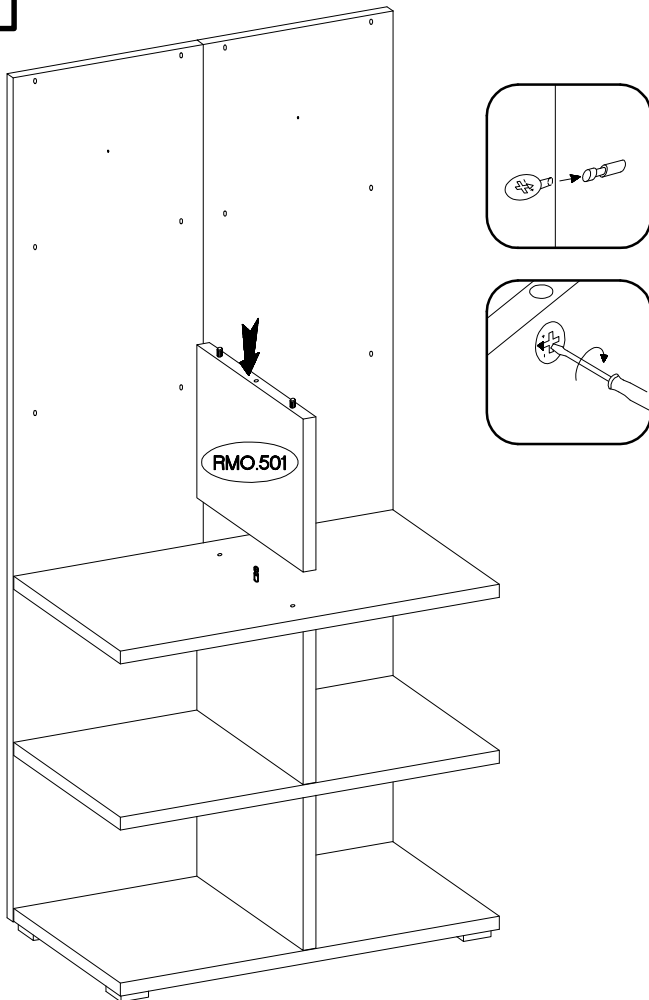

10

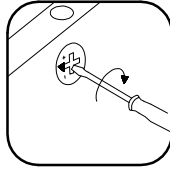
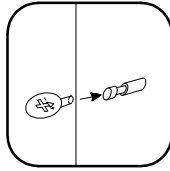
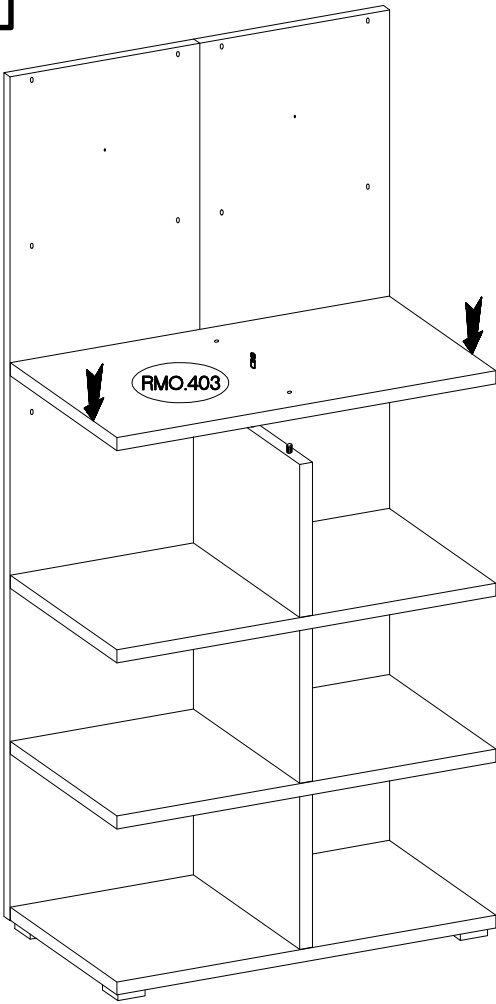

11

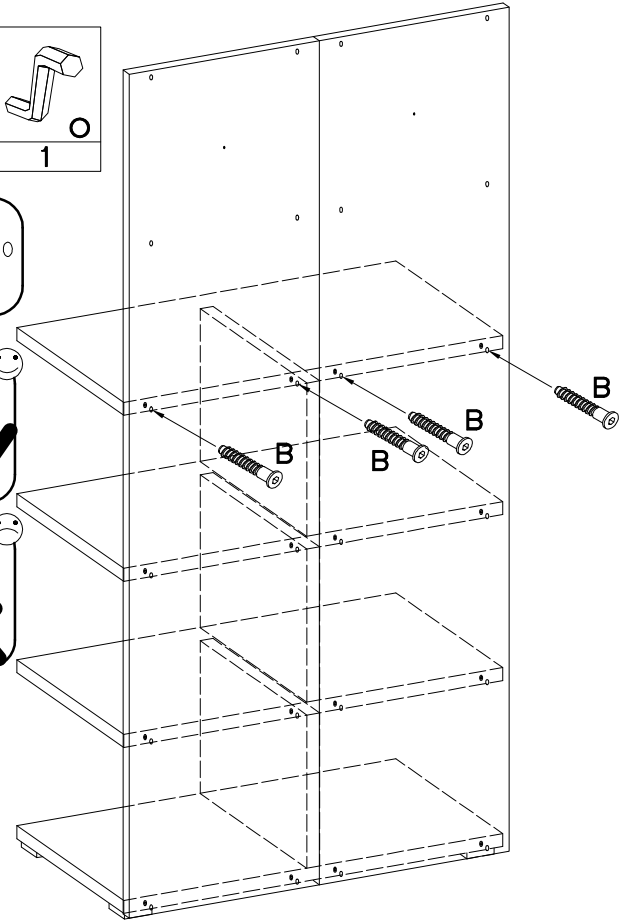
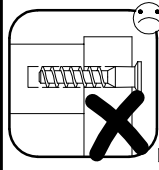
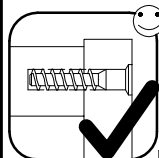
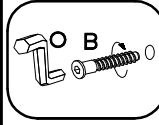
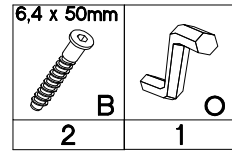

12

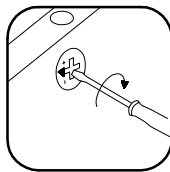
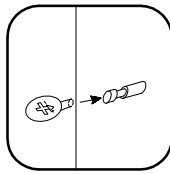
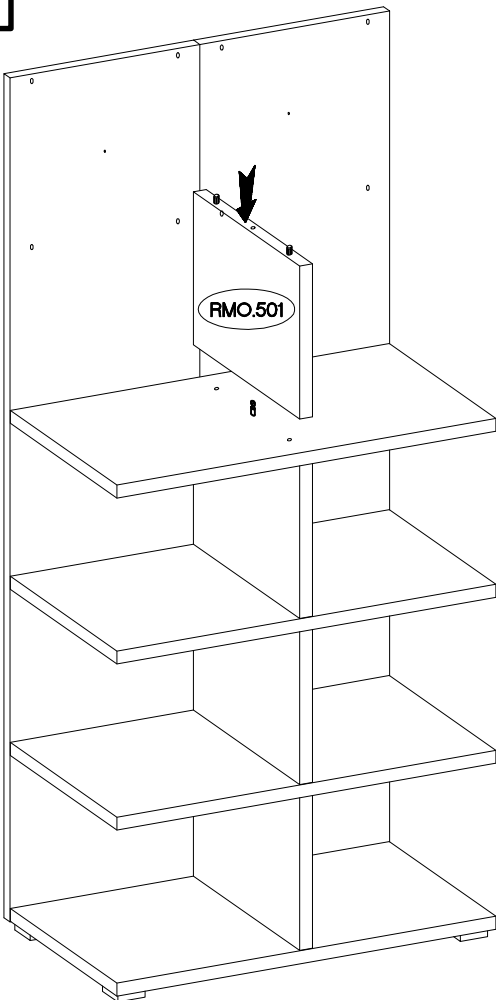

13

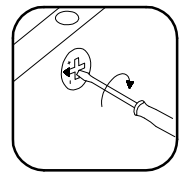
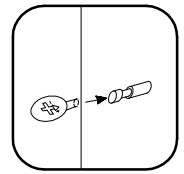
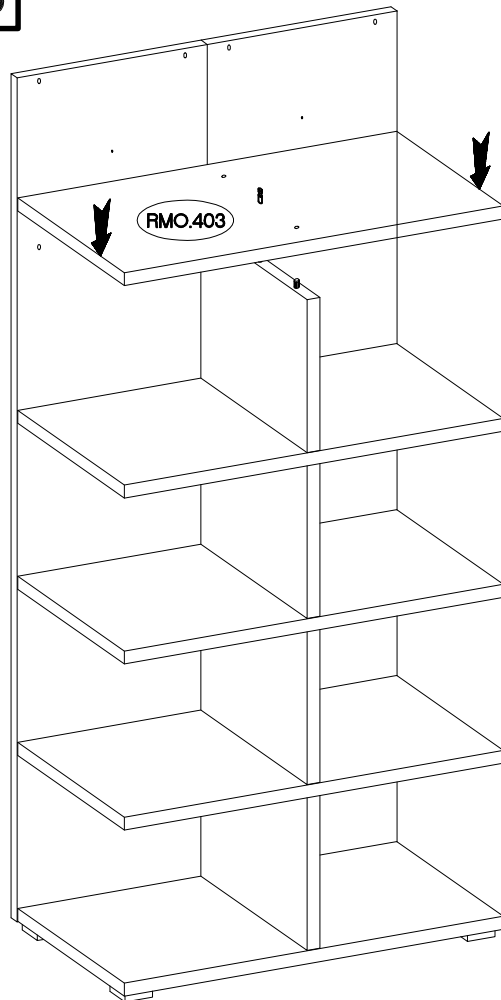

14

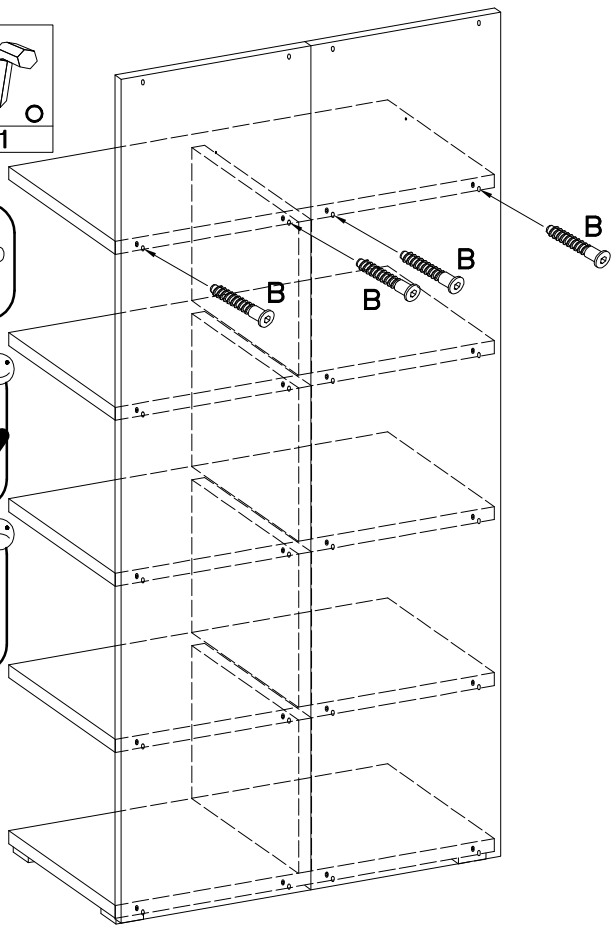
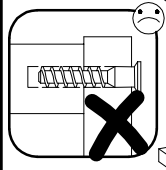
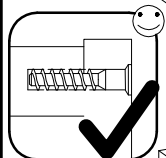
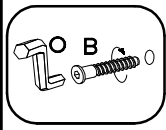
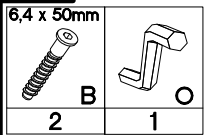

15

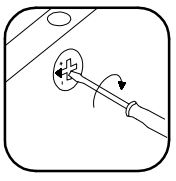
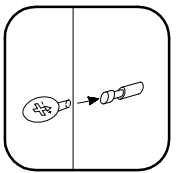
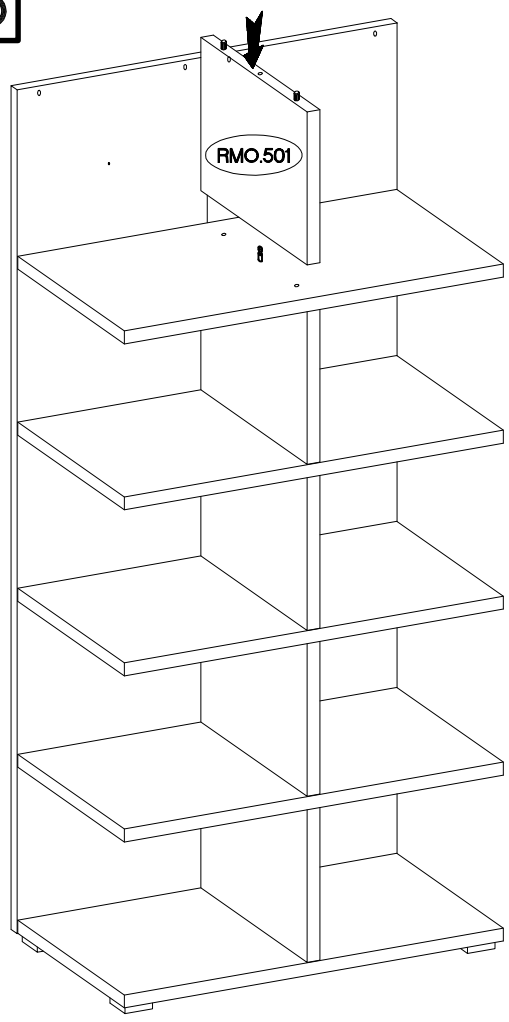

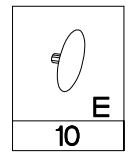
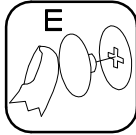
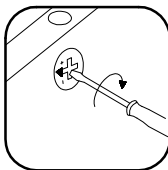
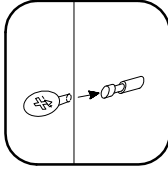
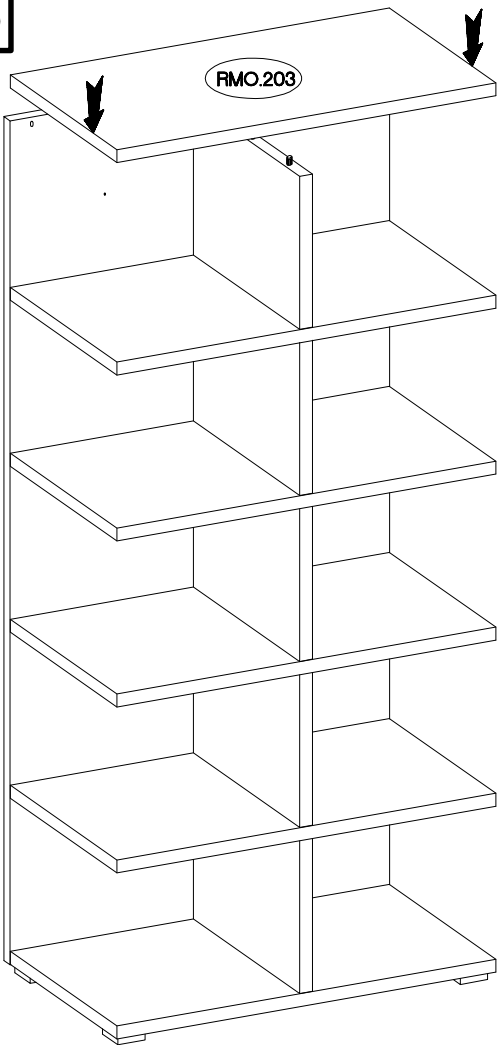

16

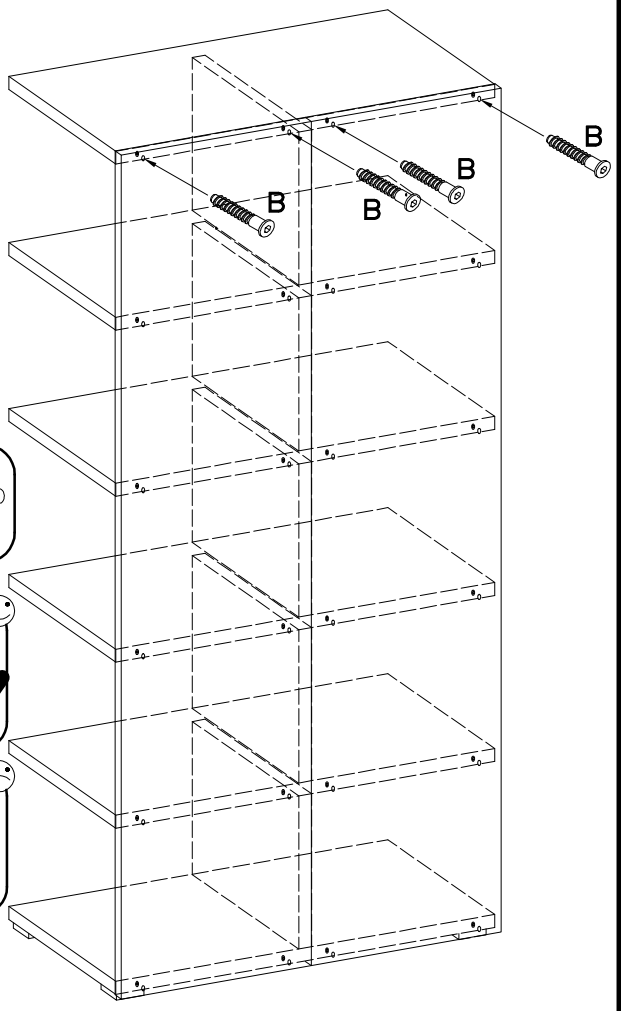
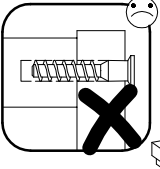
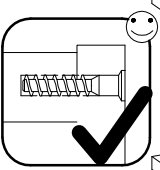
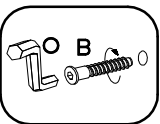
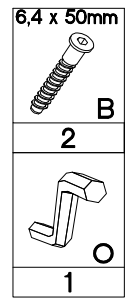

17



 $\varnothing 10 \times 50 \text{mm}$	 $\varnothing 5.0 \times 70 \text{mm}$	 $\varnothing 20$
O7 2	P29 2	E11 2

$\varnothing 10 \text{mm}$

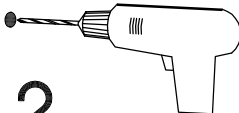

2.

O7

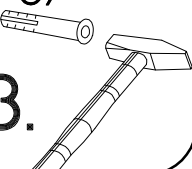

3.

