

# NVIF01

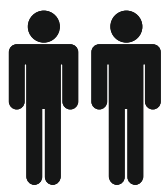

120 min

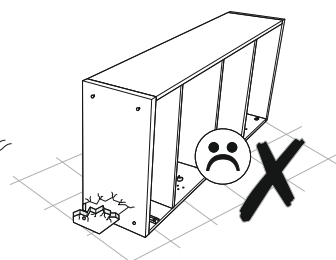

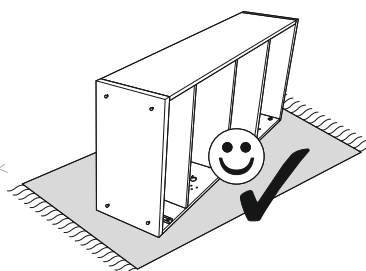
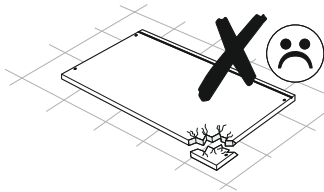
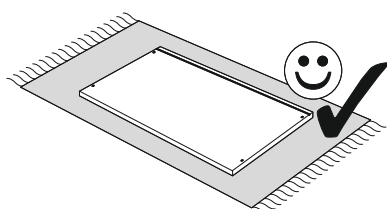
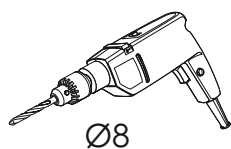
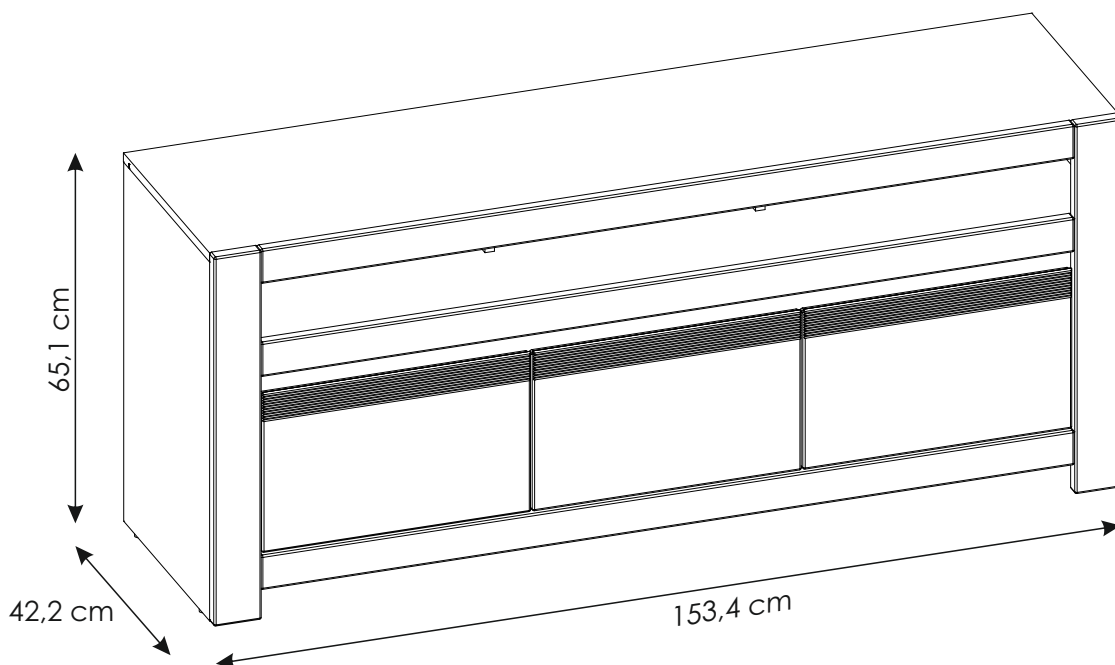
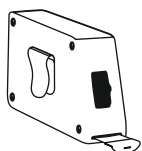
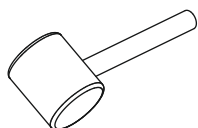
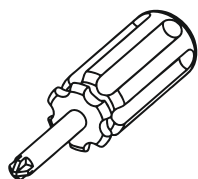
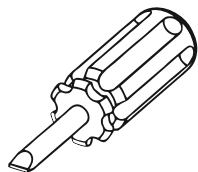
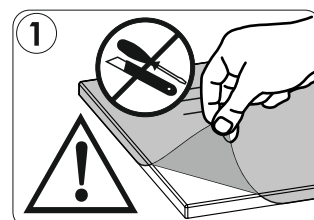
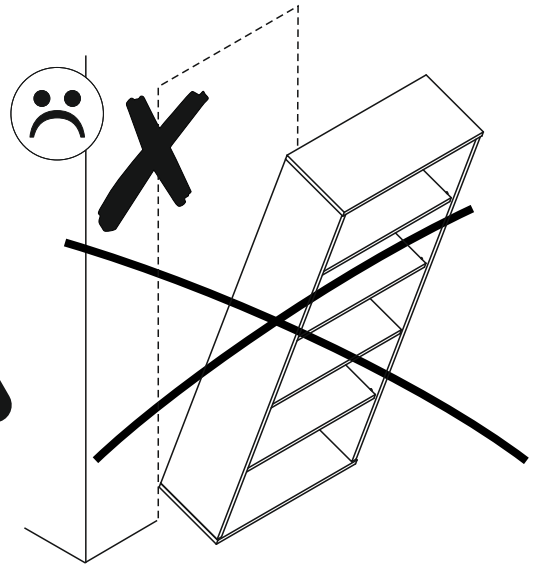
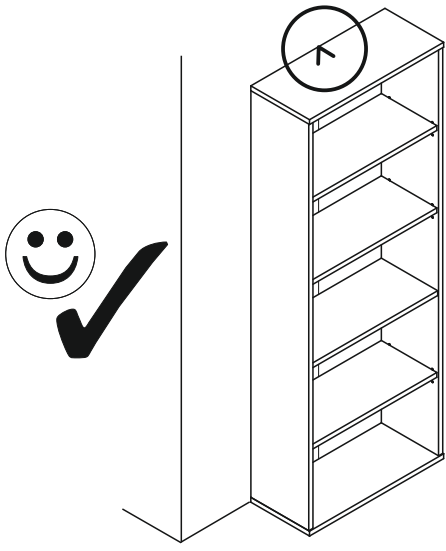

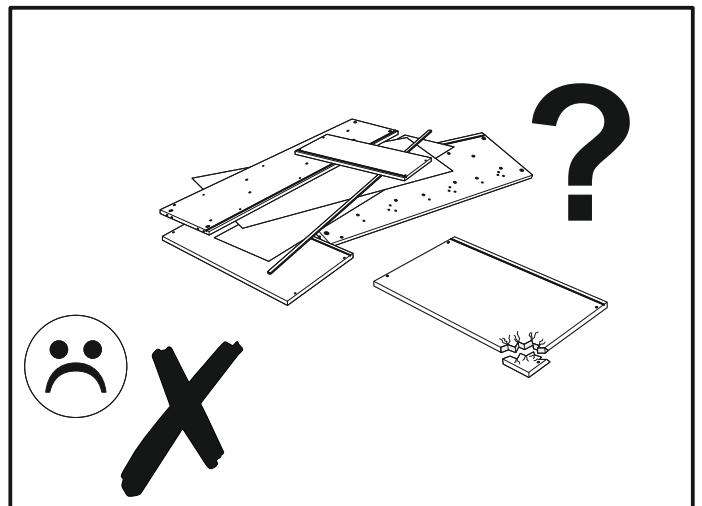
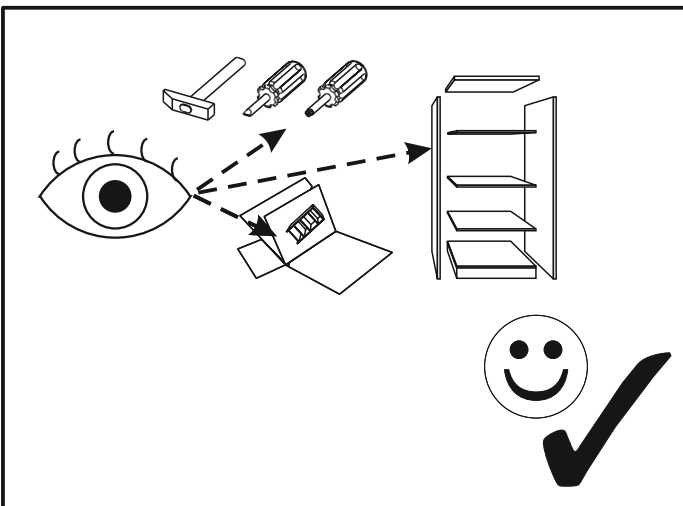
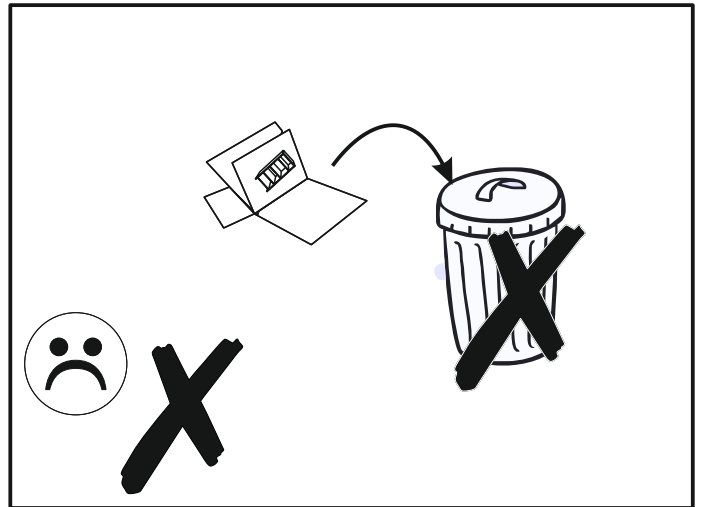
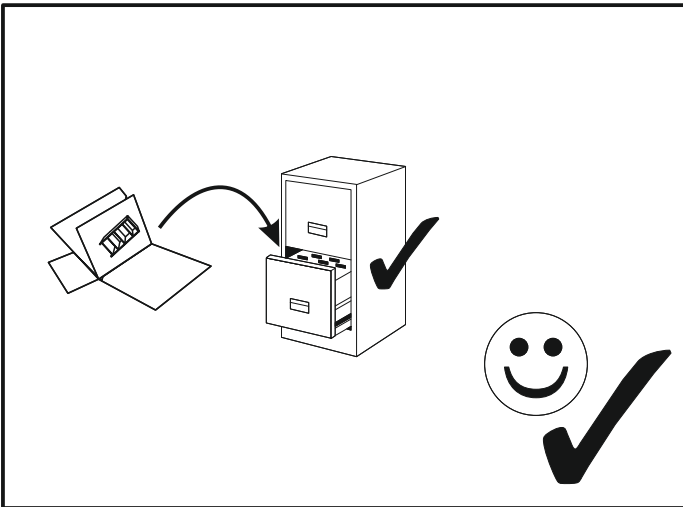
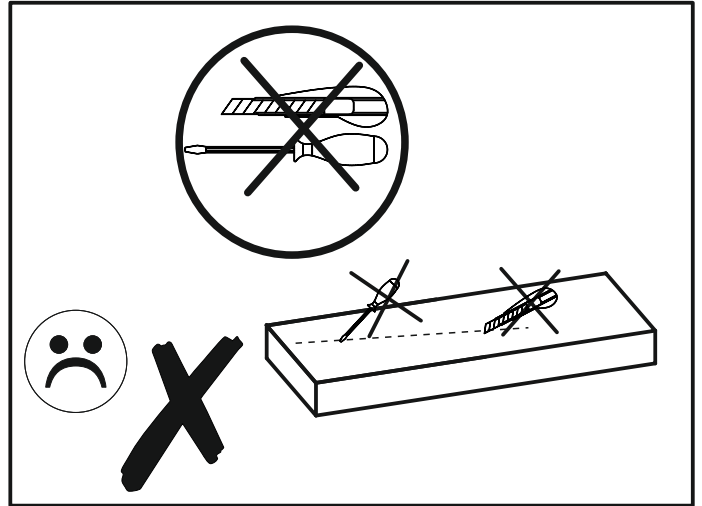
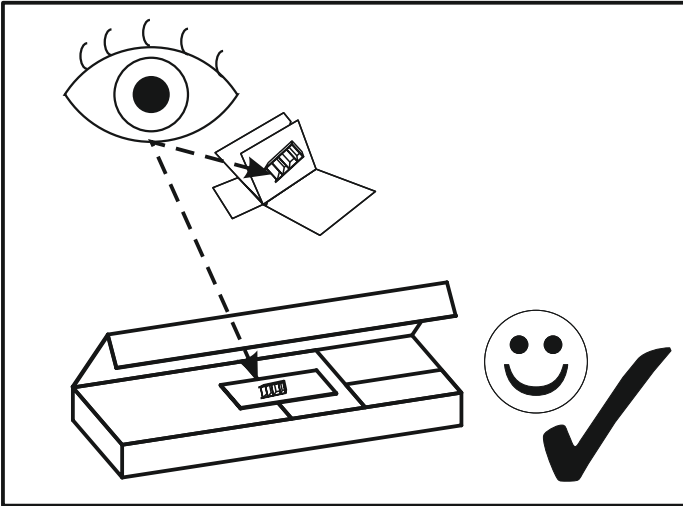



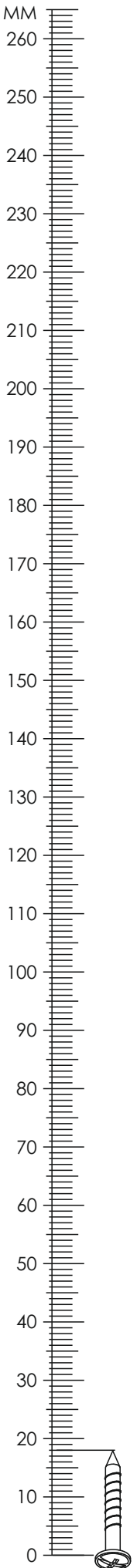

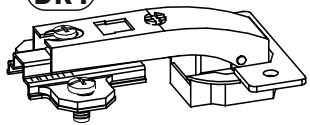



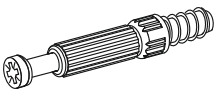
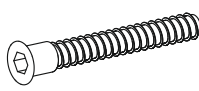

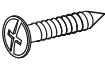
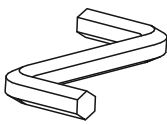
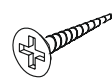
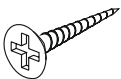
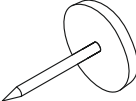
# NVIF01

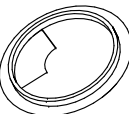
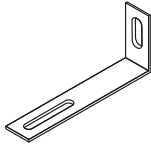
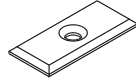
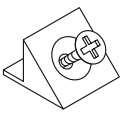
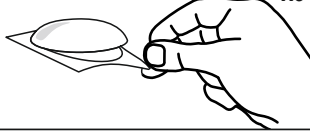
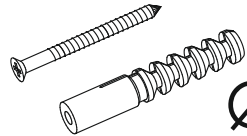
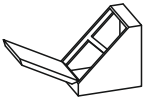

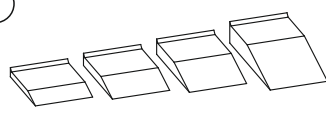
<b>A1</b> 8 x 35 mm x48 	<b>B7 + BR1</b> x4 	<b>C1</b> 4 x 13 mm x8 
<b>C2</b> 5 x 13 mm x4 	<b>E0</b> x37 	<b>E1</b> 15 x 12 mm x45 
<b>F1</b> 6 x 34 mm x45 	<b>G1</b> 7 x 50 mm x8 	<b>I2</b> 4 x 16 mm x2 
<b>I7</b> 3,5 x 27 mm x2 	<b>M</b> x1 	<b>N1</b> 3 X 16 mm x35 
<b>N2</b> 3,5 X 16 mm x16 	<b>O2</b> x6 	<b>PW</b> L - 350 mm x2 
<b>P24</b> x3 	<b>Q9</b> x2 	<b>R1</b> x10 
<b>R4</b> x9 	<b>R8</b> x6 	<b>S13</b> x2  Ø8
<b>W</b> x3 	<b>W1</b> x2 	<b>Z</b> x1 

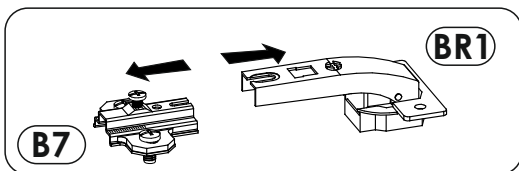

# NVIF01

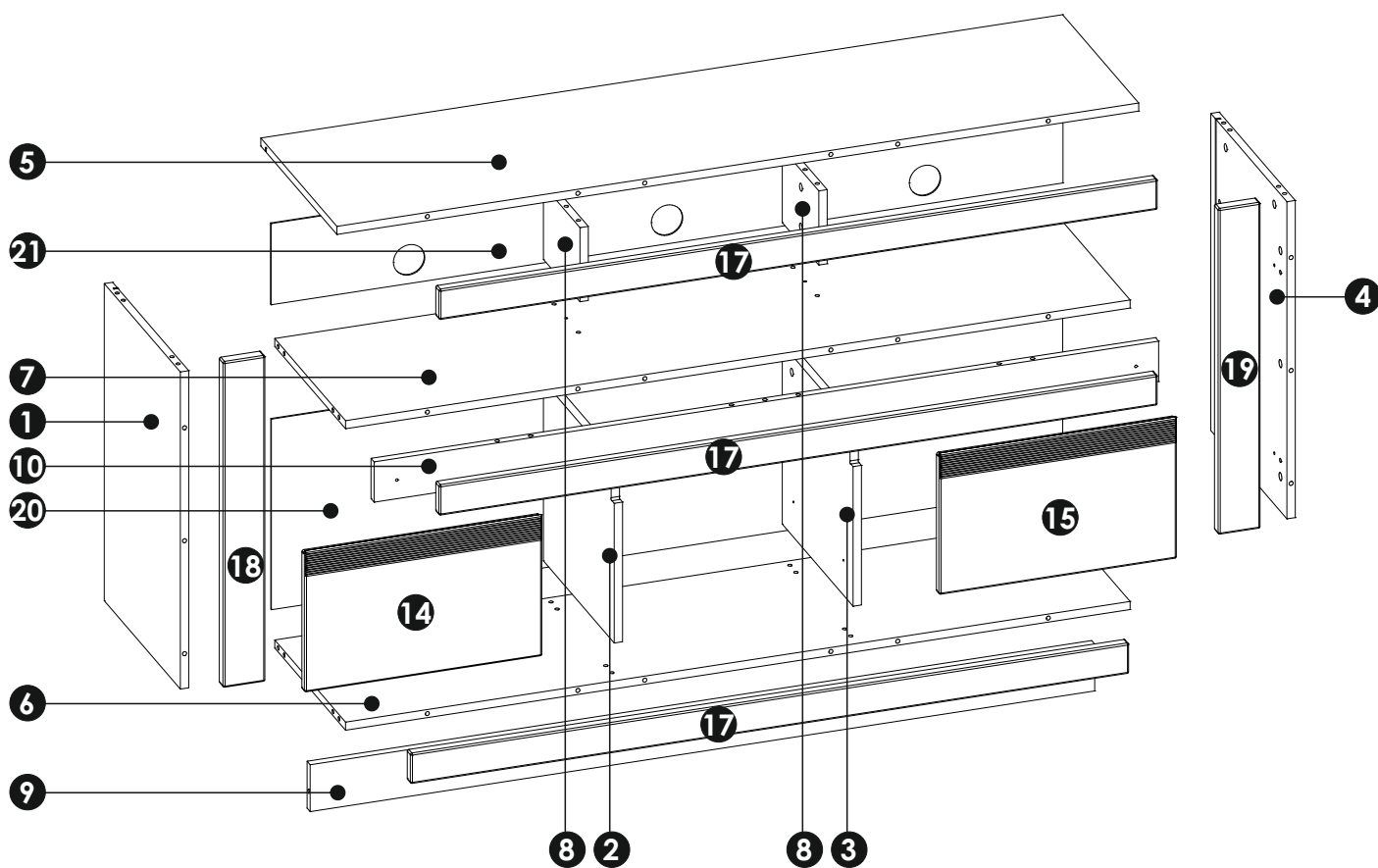
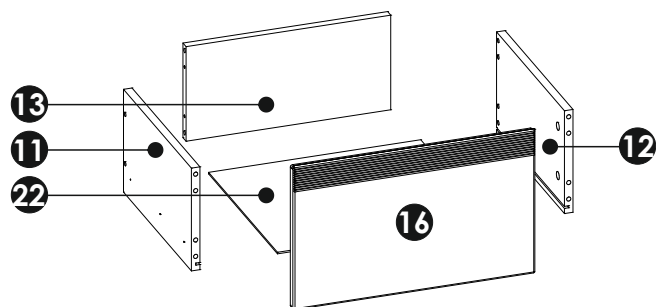
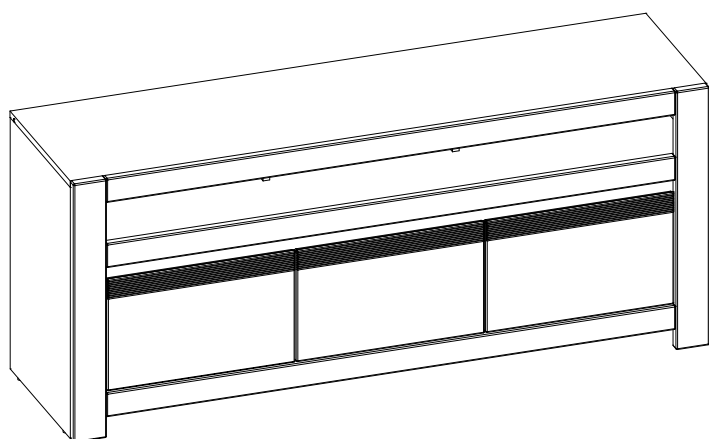

<b>1</b>	629	400	16	x1	1/2
<b>2</b>	357	372	16	x1	1/2
<b>3</b>	357	372	16	x1	1/2
<b>4</b>	629	400	16	x1	1/2
<b>5</b>	1534	400	16	x1	2/2
<b>6</b>	1501	372	16	x1	2/2
<b>7</b>	1501	372	16	x1	2/2
<b>8</b>	147	192	16	x2	1/2

<b>9</b>	1501	93	16	x1	2/2
<b>10</b>	1501	80	16	x1	2/2
<b>11</b>	350	200	16	x1	1/2
<b>12</b>	350	200	16	x1	1/2
<b>13</b>	384	184	16	x1	1/2
<b>14</b>	454	280	16	x1	1/2
<b>15</b>	454	280	16	x1	1/2
<b>16</b>	454	280	16	x1	1/2

<b>17</b>	1374	60	19	x3	2/2
<b>18</b>	646	80	22	x1	1/2
<b>19</b>	646	80	22	x1	1/2
<b>20</b>	1515	378	3	x1	2/2
<b>21</b>	1515	161	3	x1	2/2
<b>22</b>	398	355	3	x1	1/2

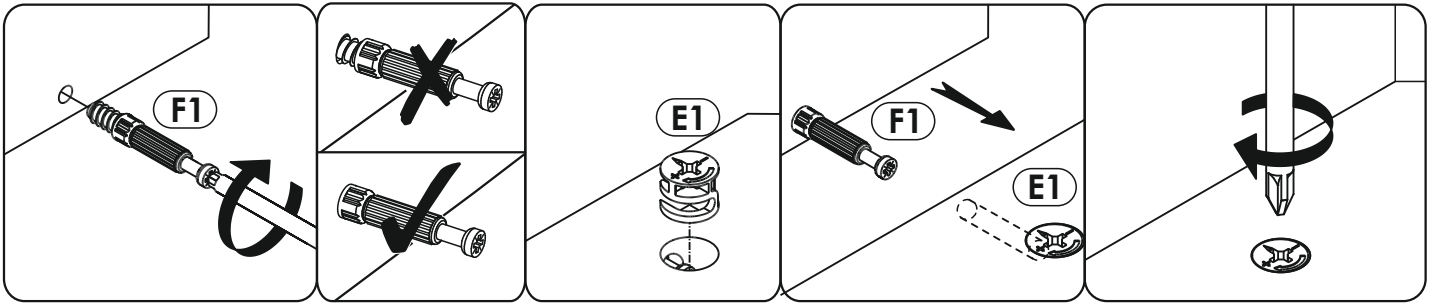

1 ▶

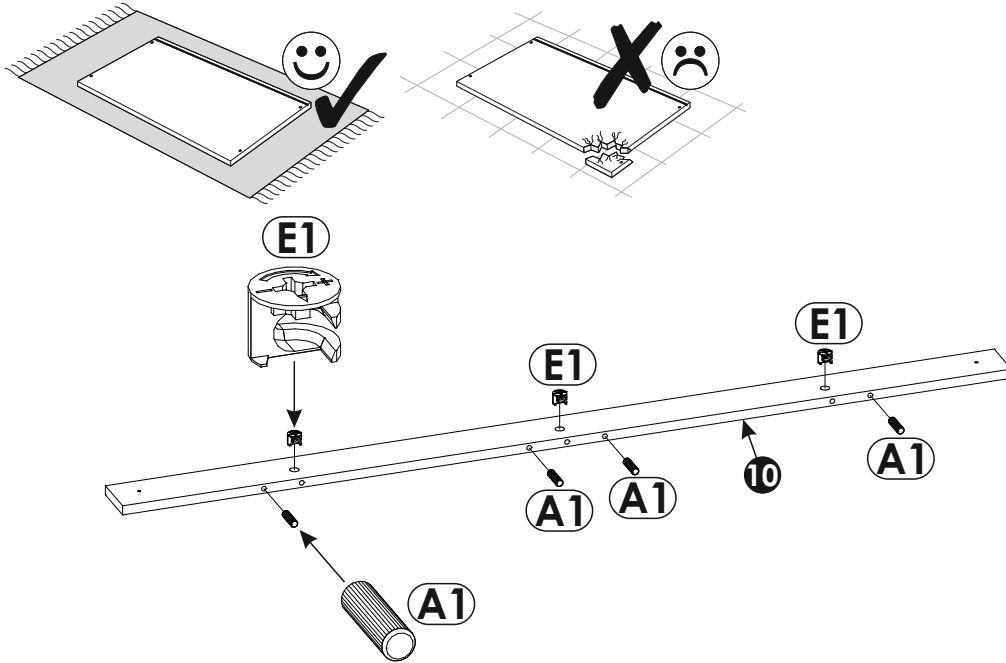

2 ▶

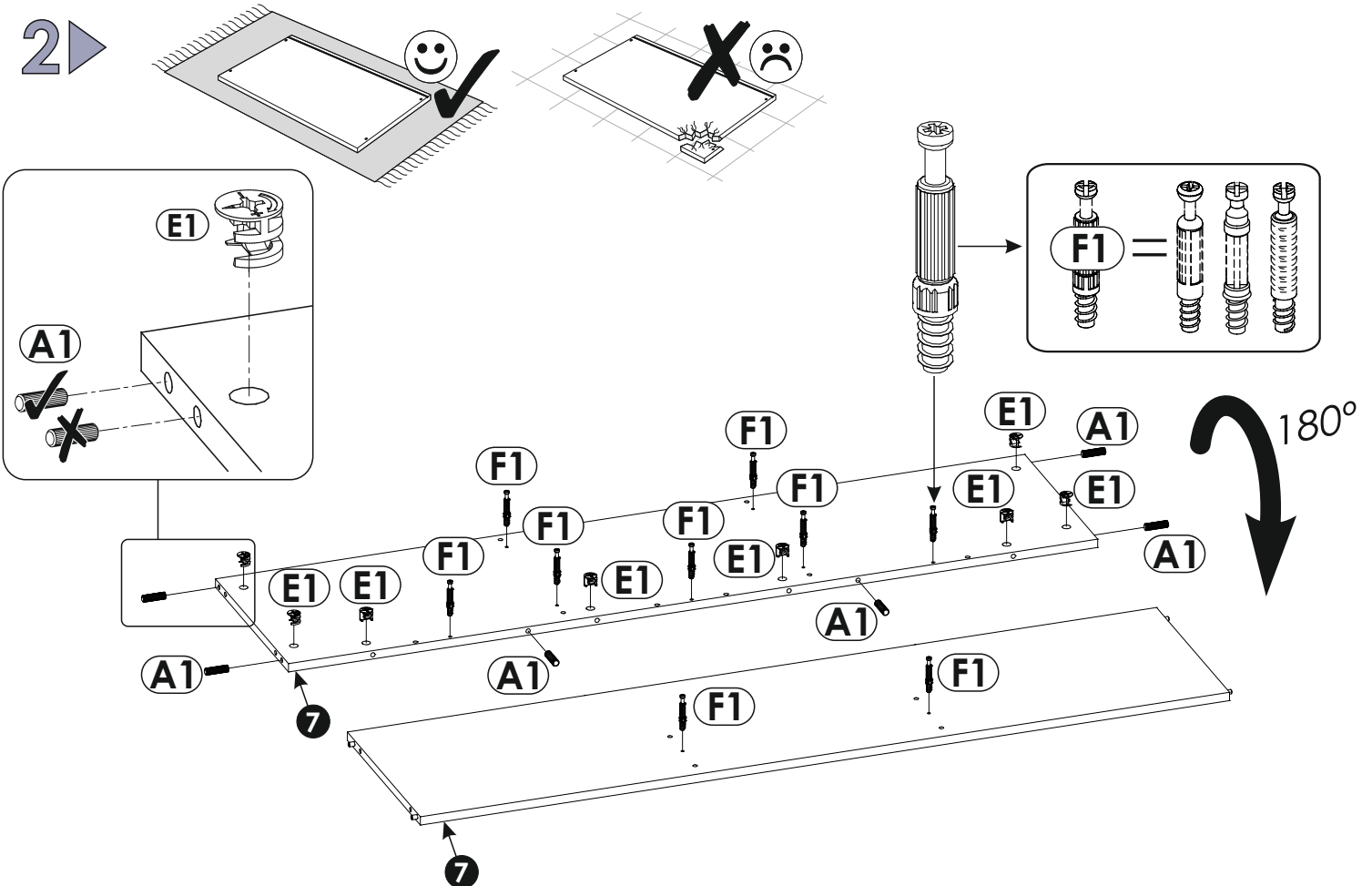

3 ▶

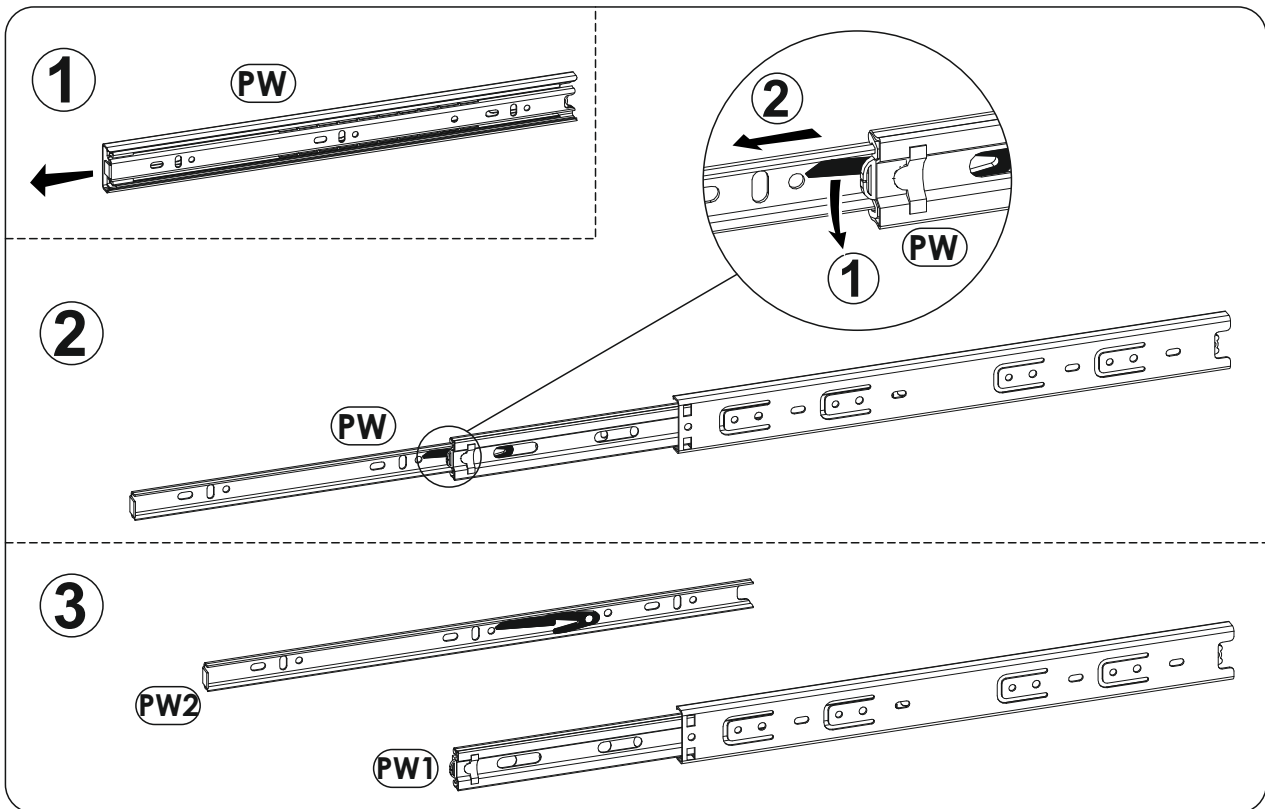
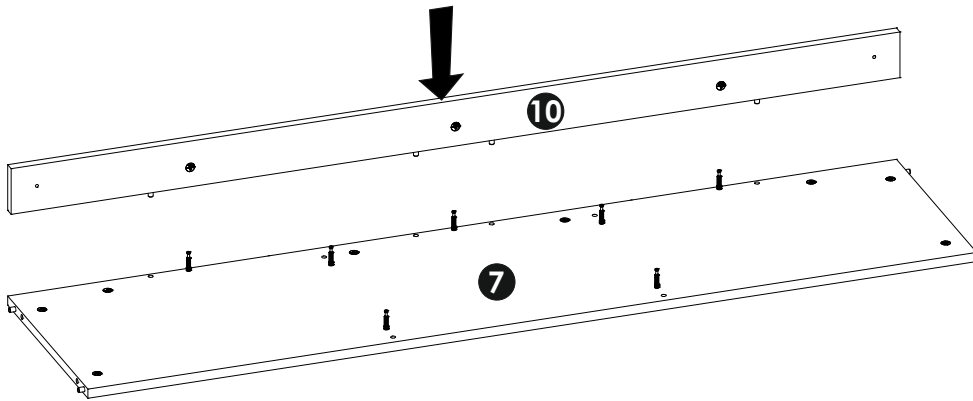
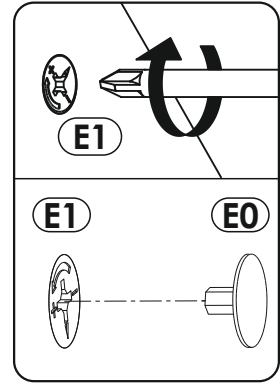
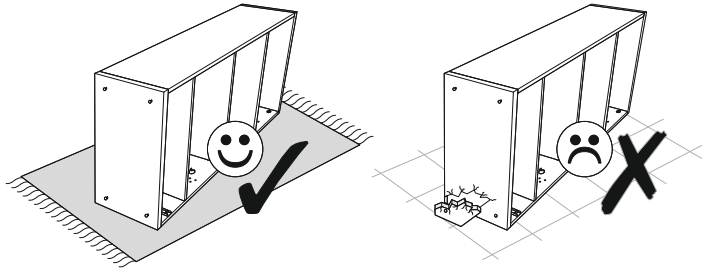

4 ▶

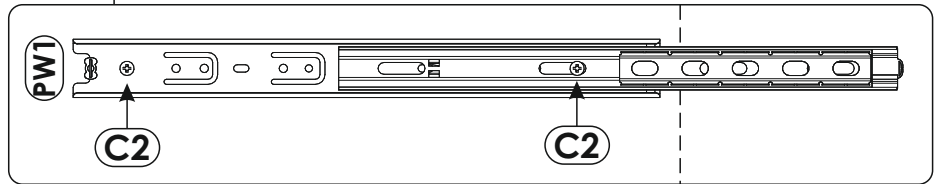
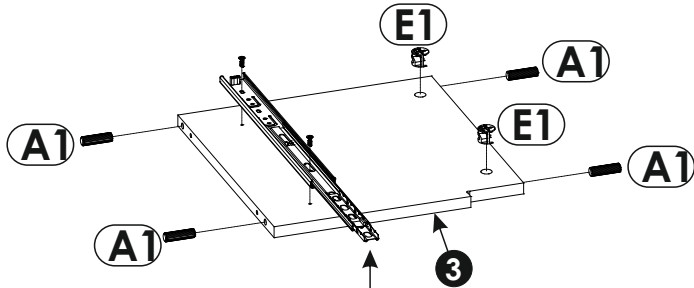
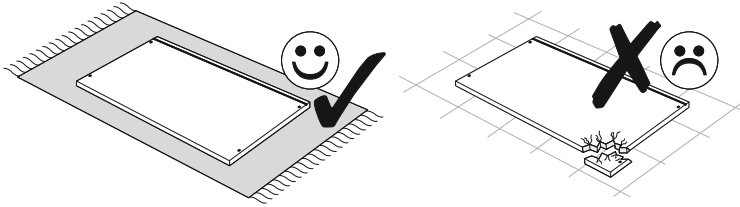

5 ▶

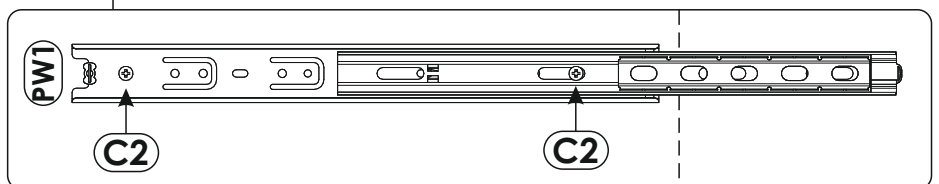
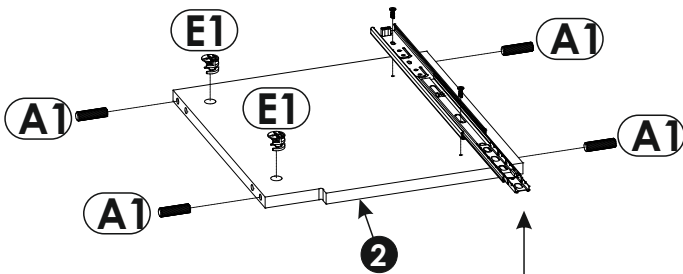
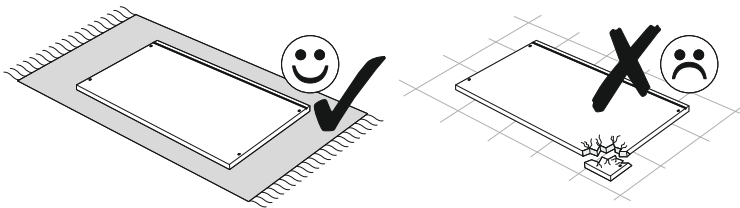



6 ▶

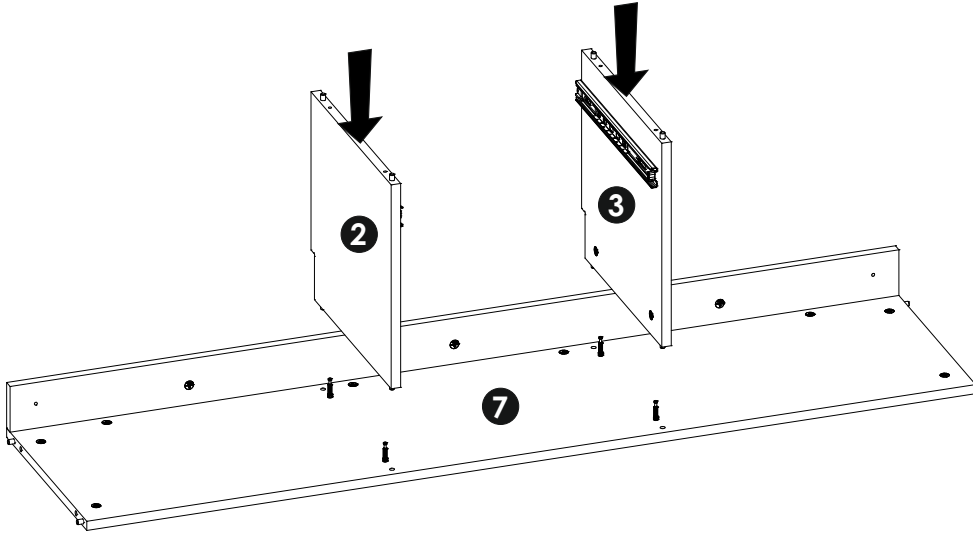
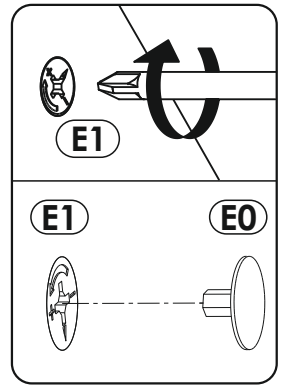
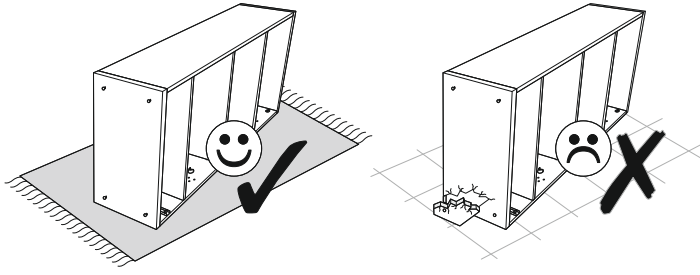

7 ▶

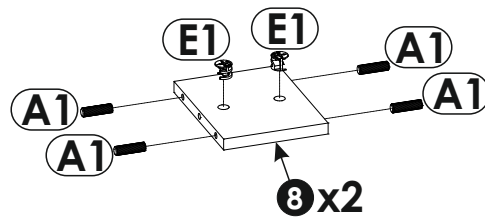
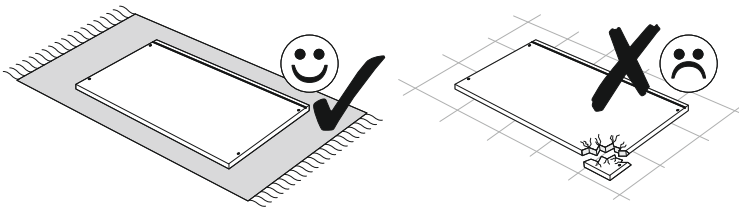

8 ▶

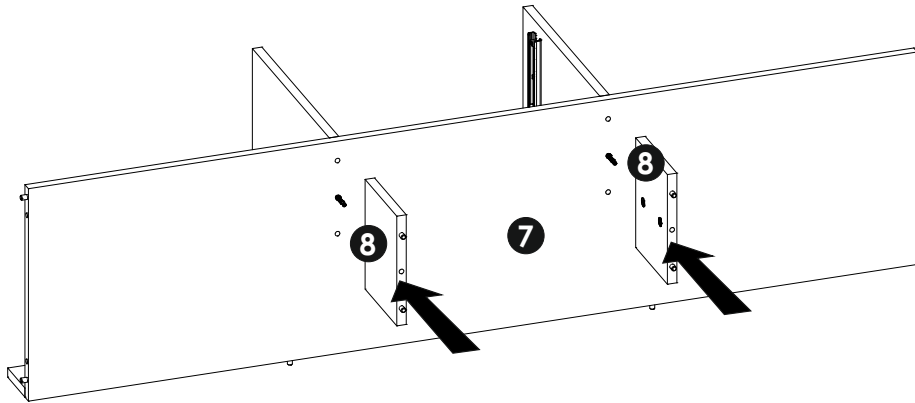
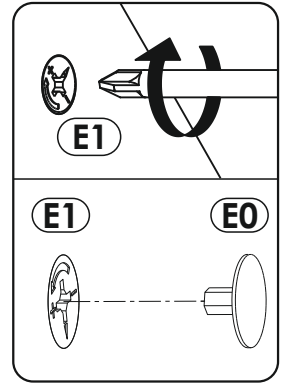
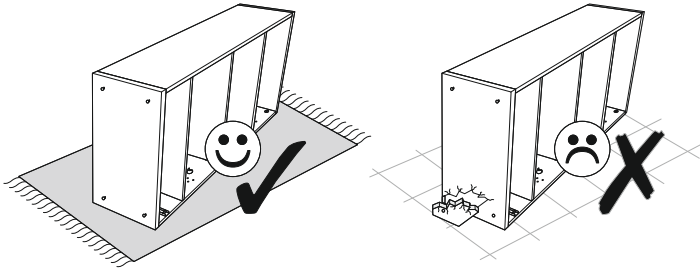

9 ▶

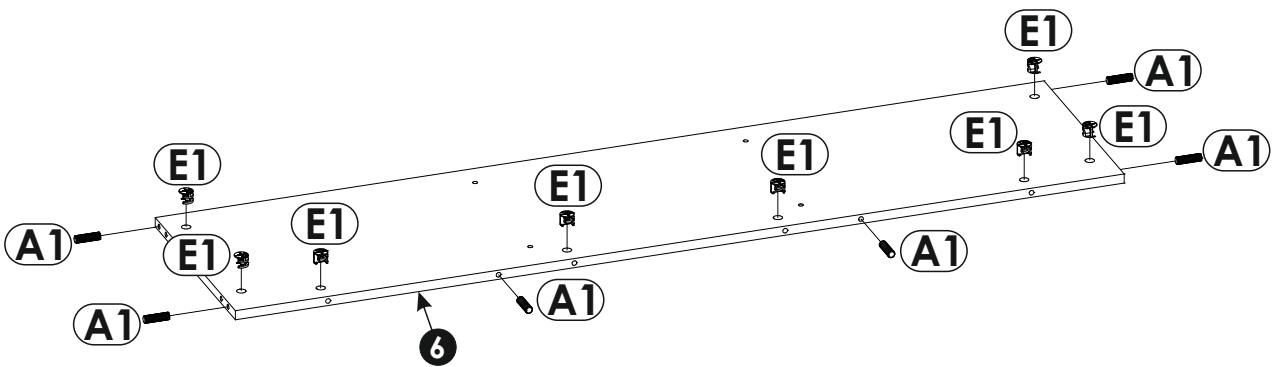
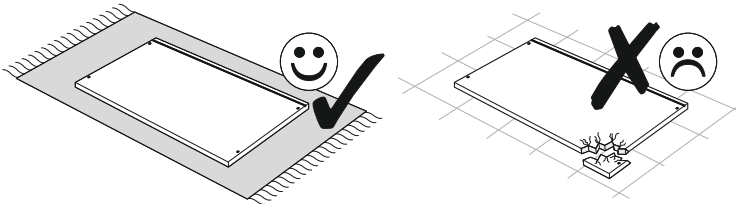

10 ▶

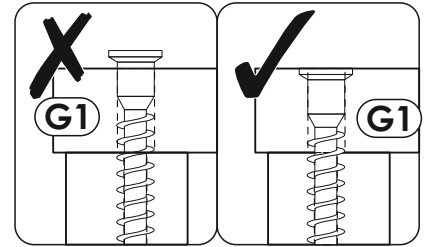
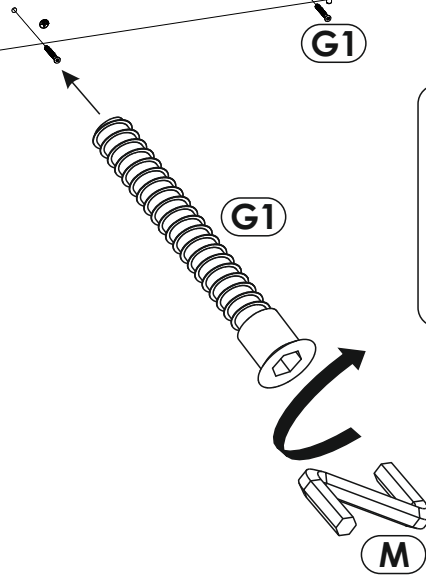
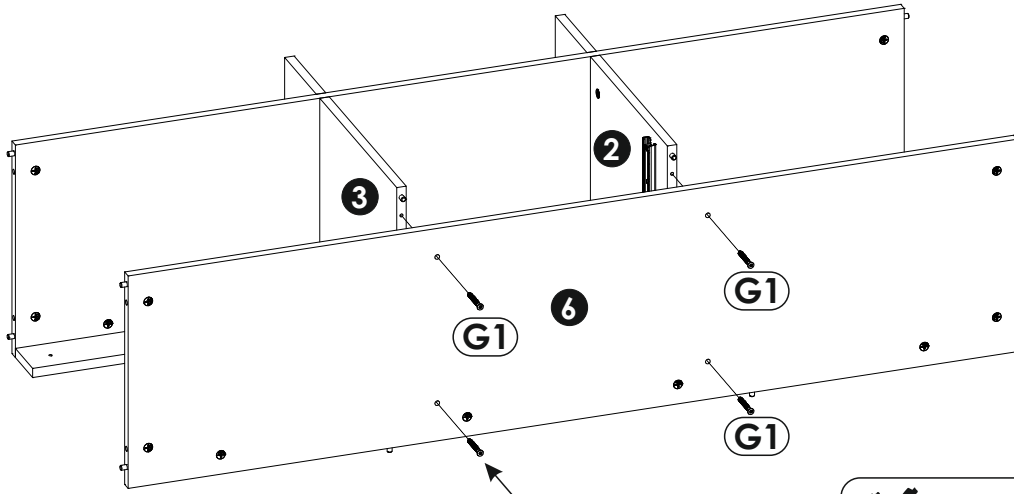
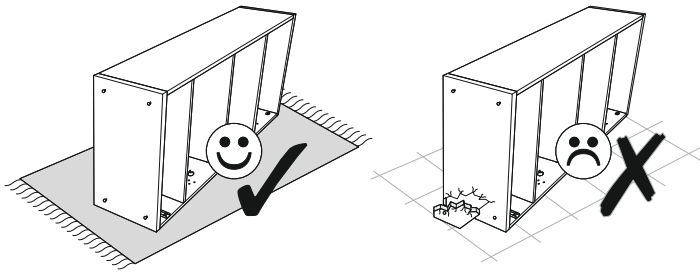

11 ▶

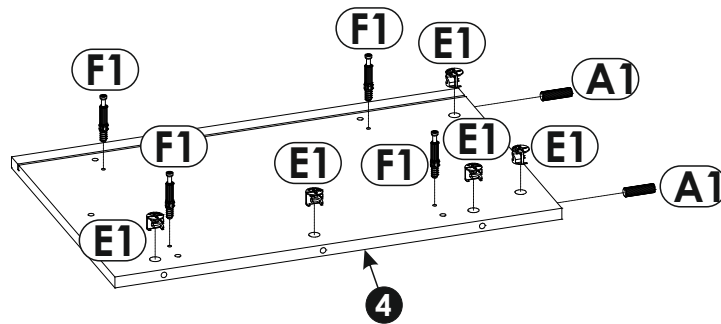
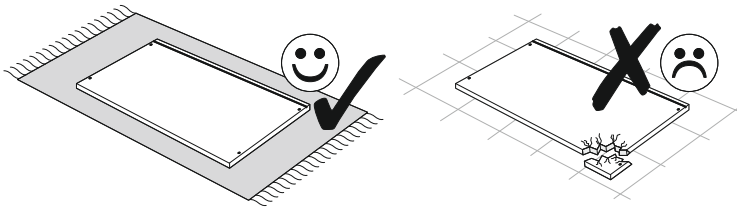

12 ▶

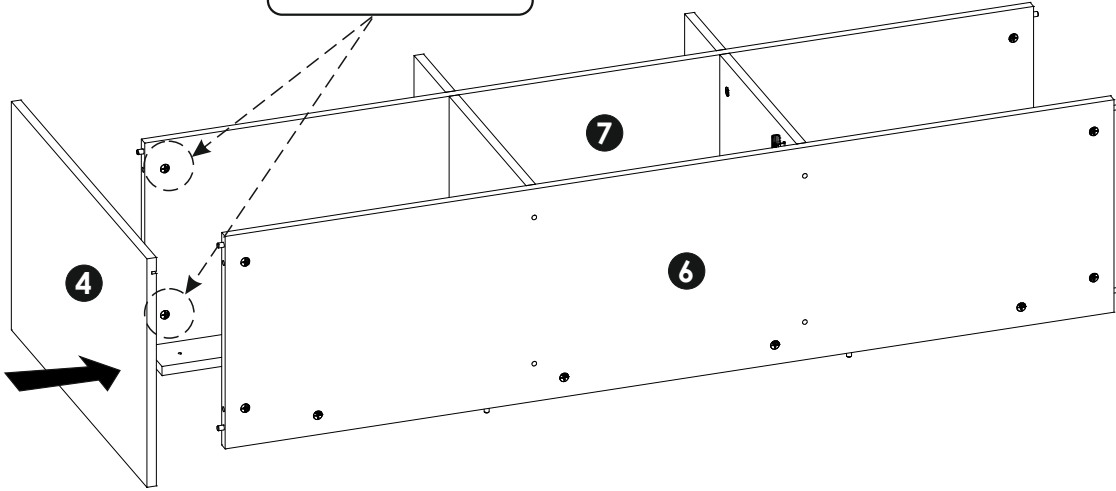
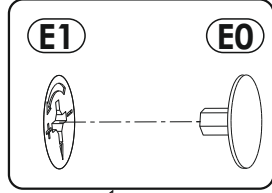
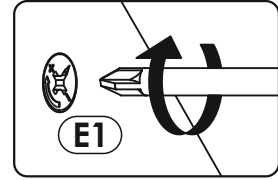
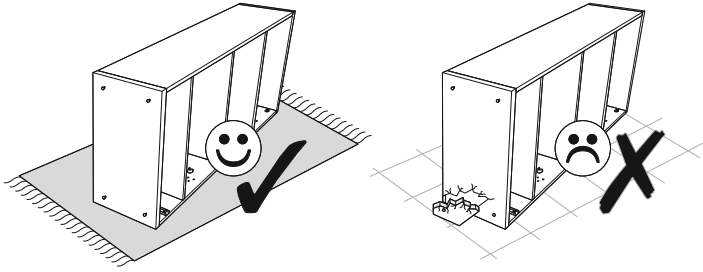

13 ▶

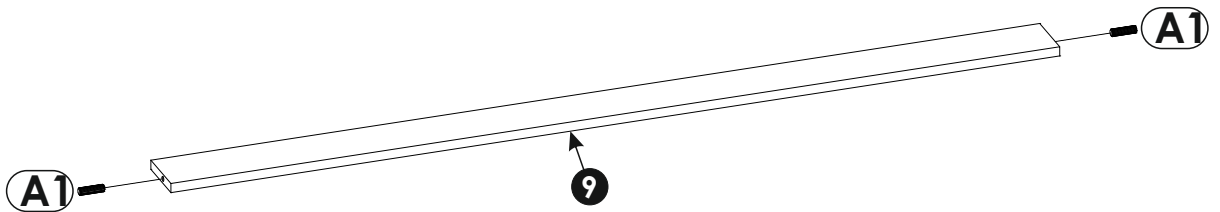
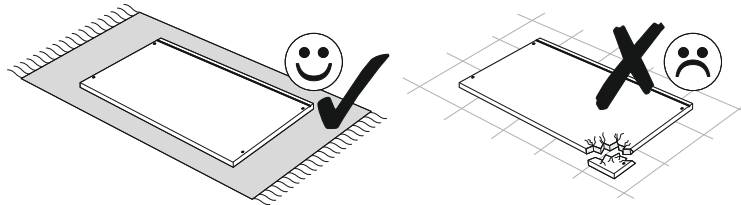

14▶

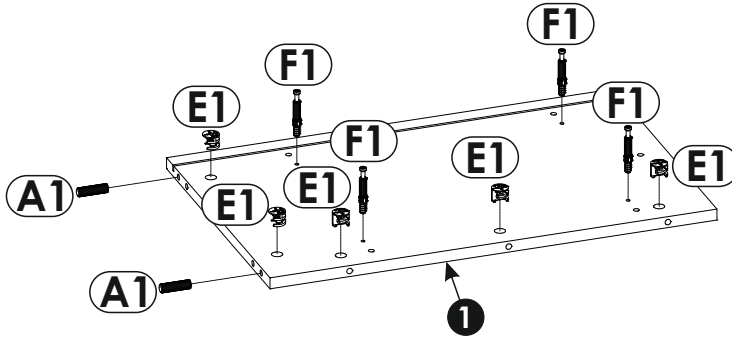
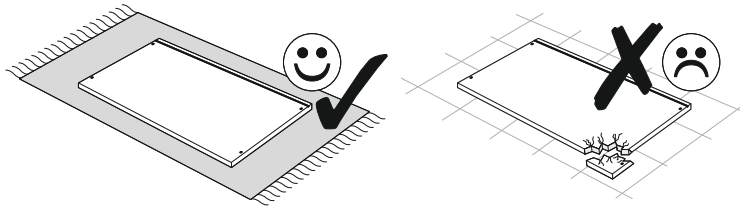

15▶

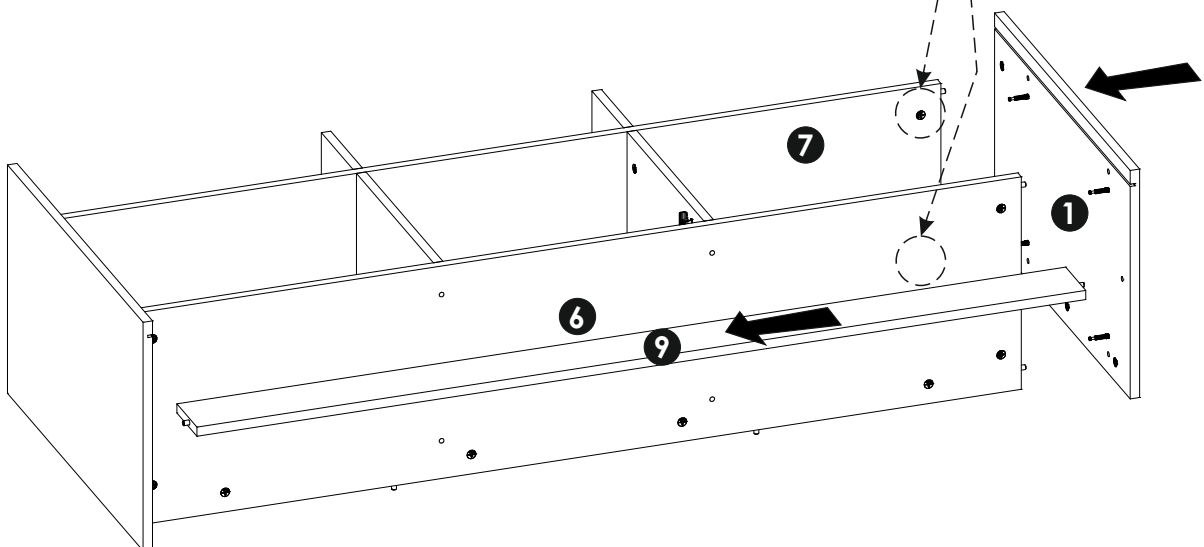
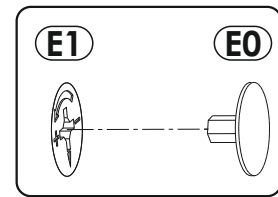
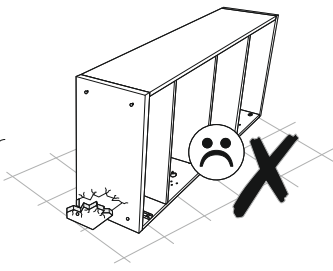
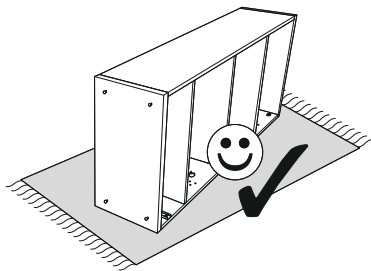

16 ▶

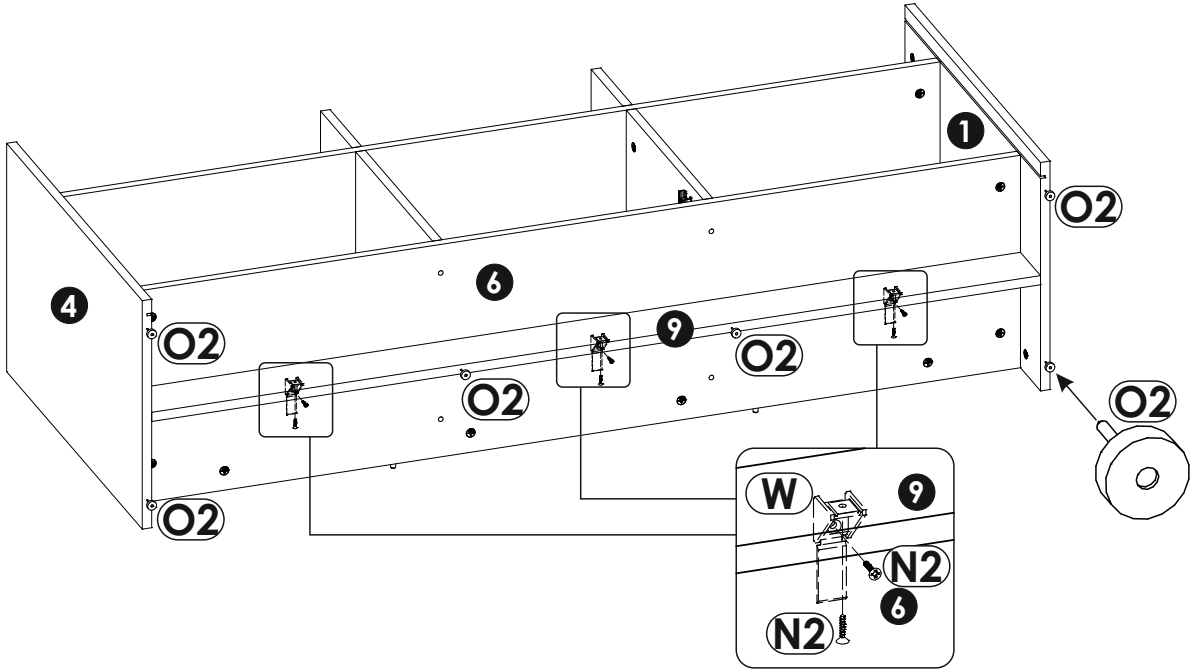
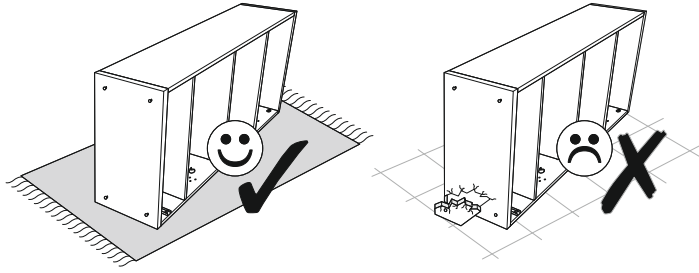

17 ▶

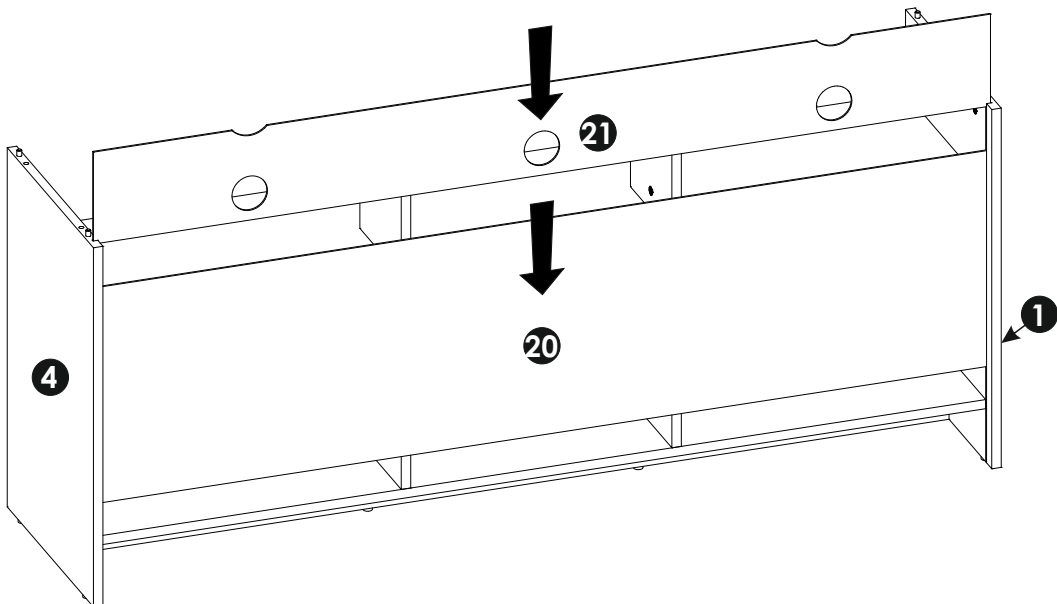

18 ▶

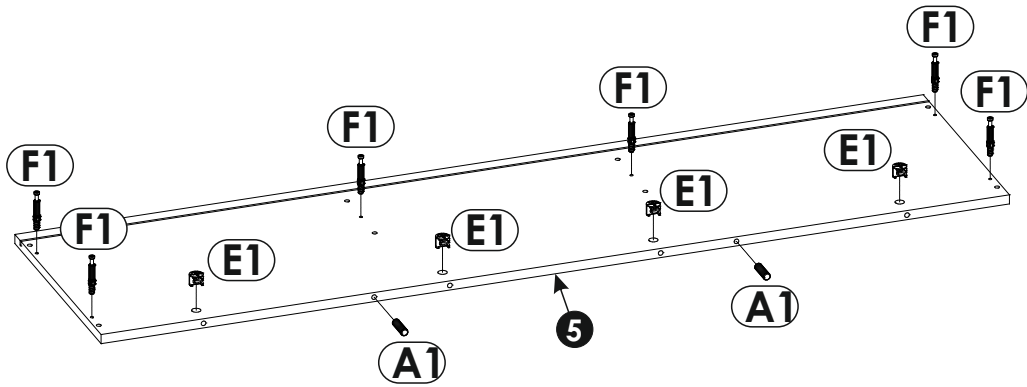
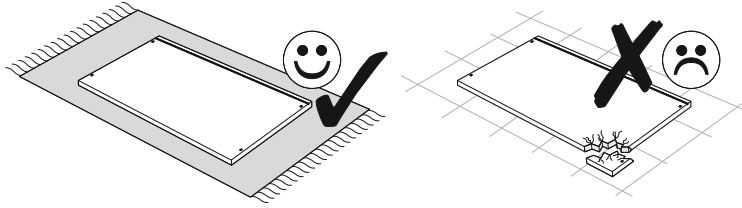

19 ▶

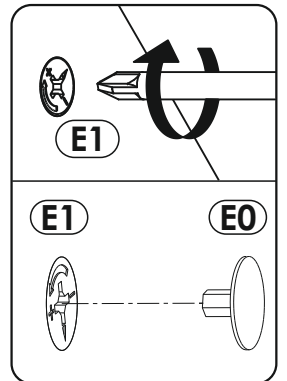
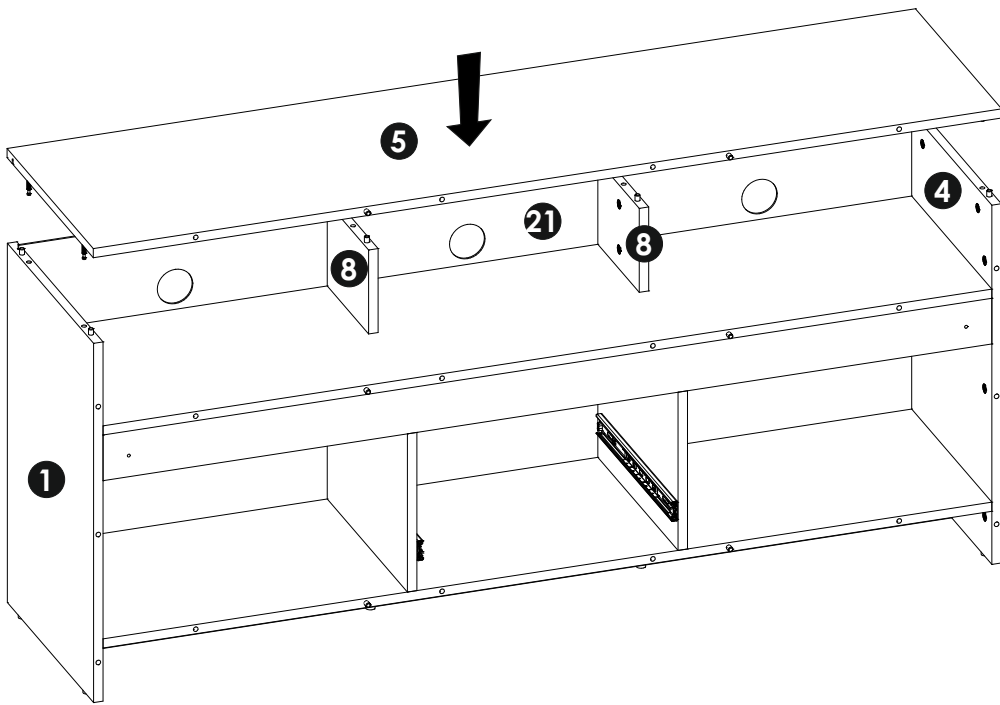

20 ▶

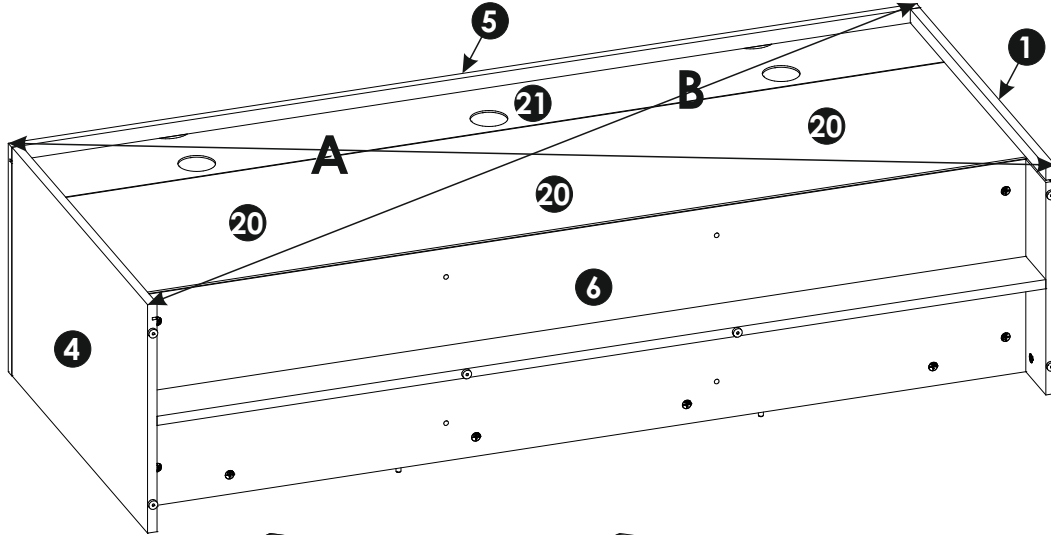
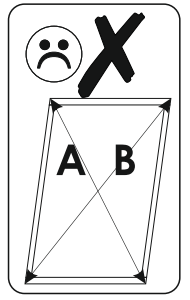
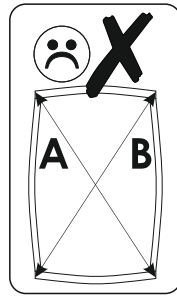
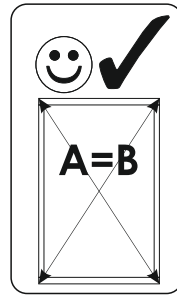
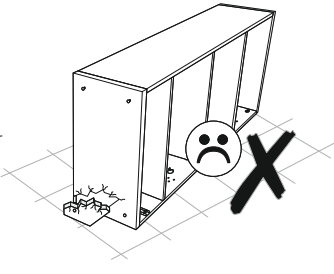
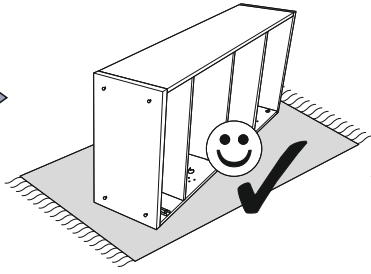

21 ▶

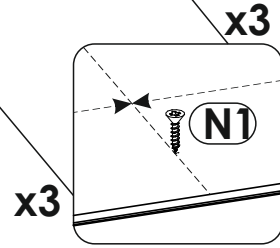
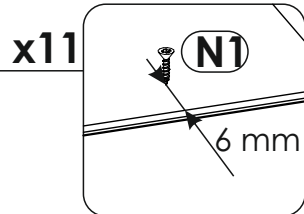
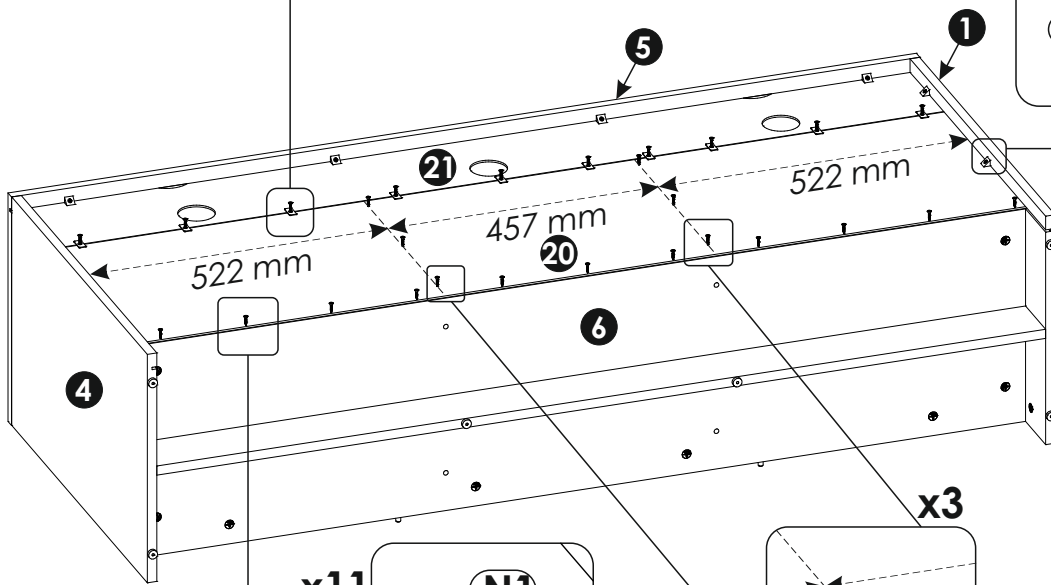
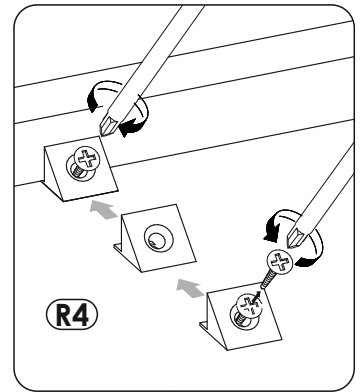
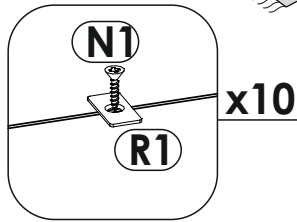
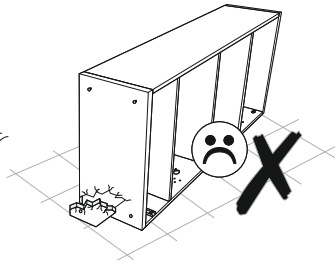
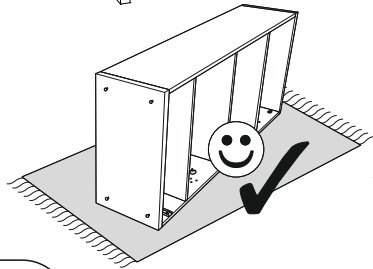



22 ▶

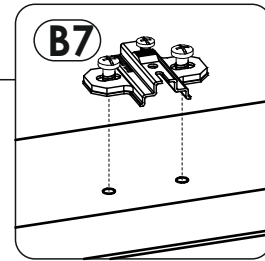
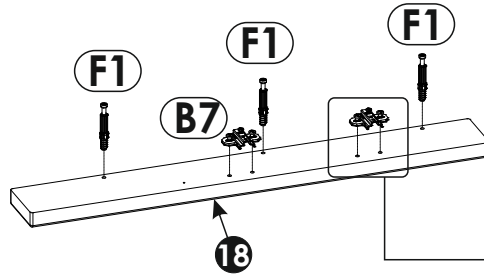
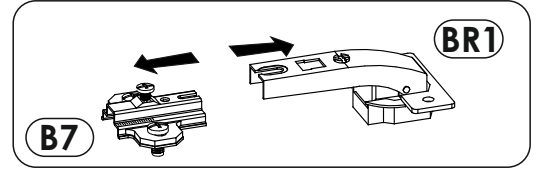
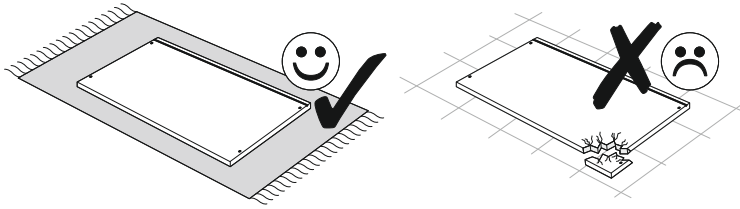

23 ▶

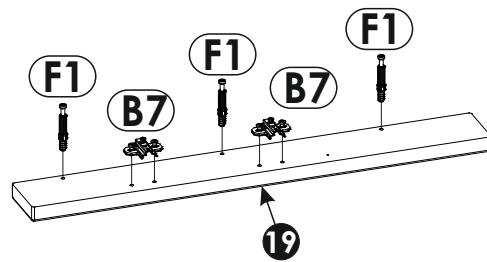
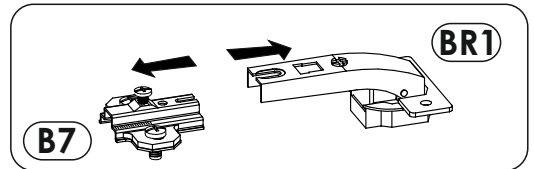
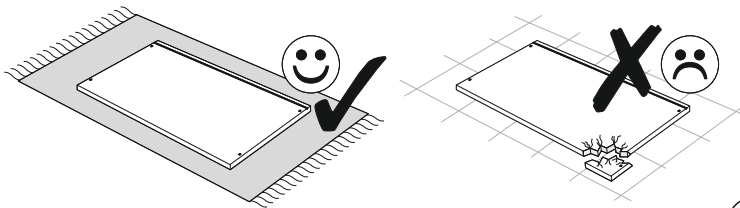

24 ▶

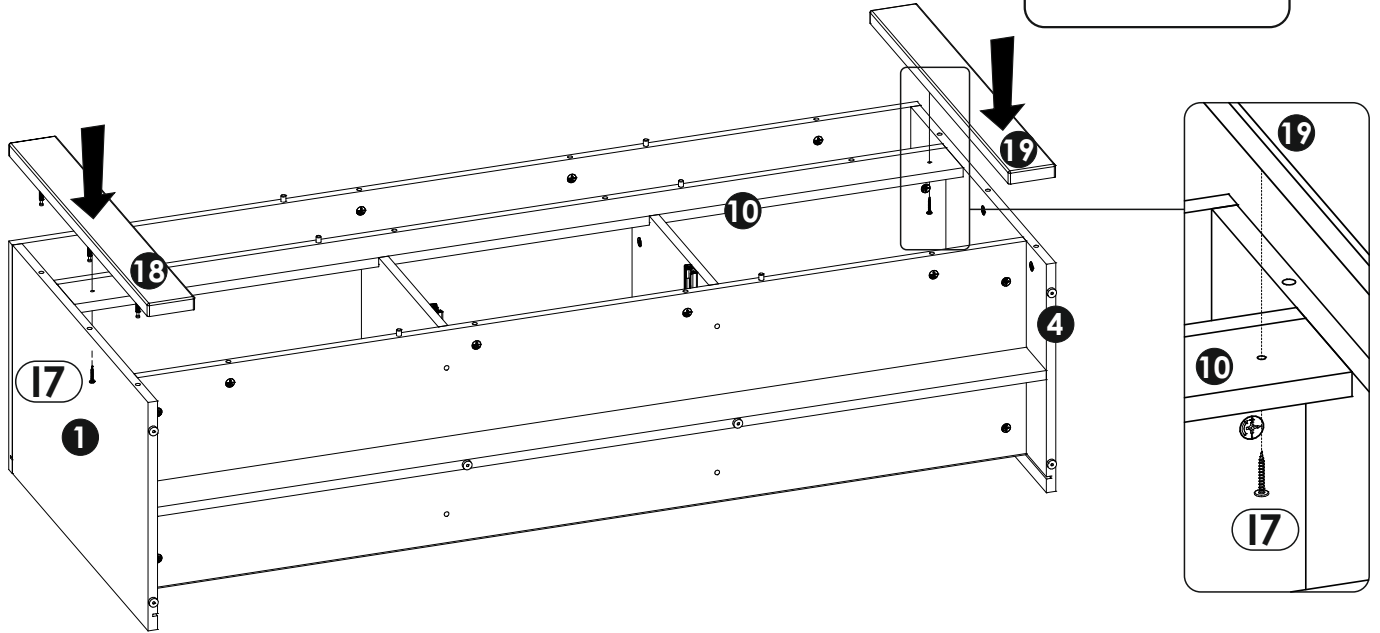
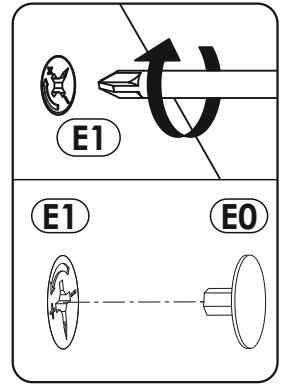
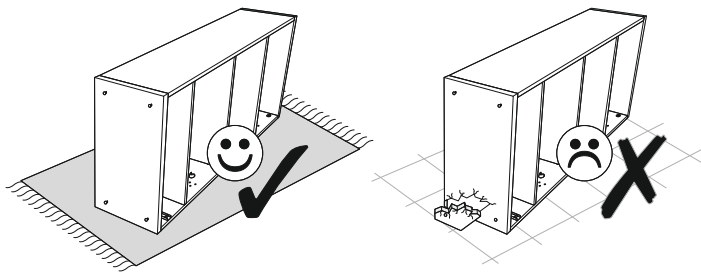

25 ▶

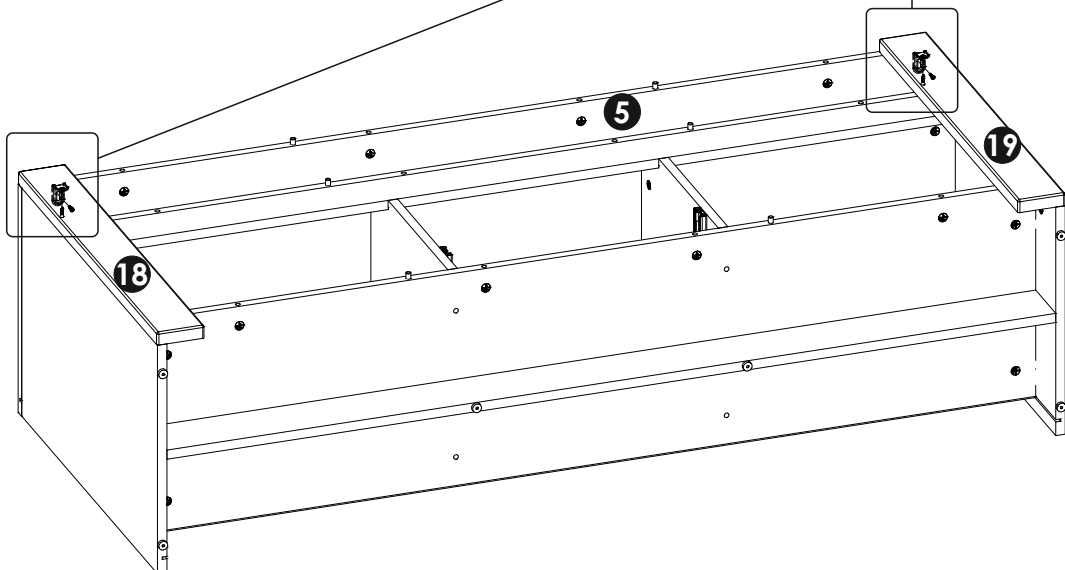
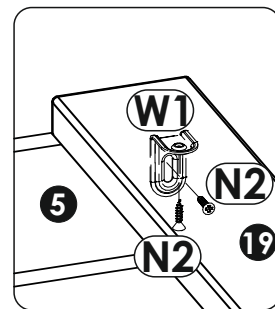
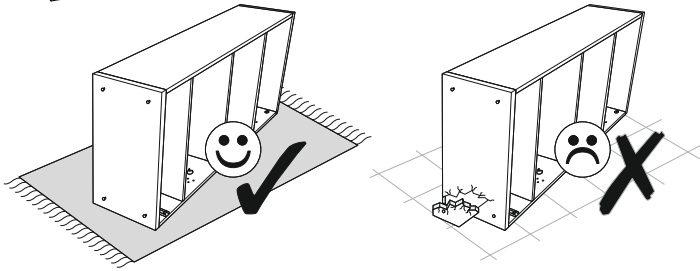

26 ▶

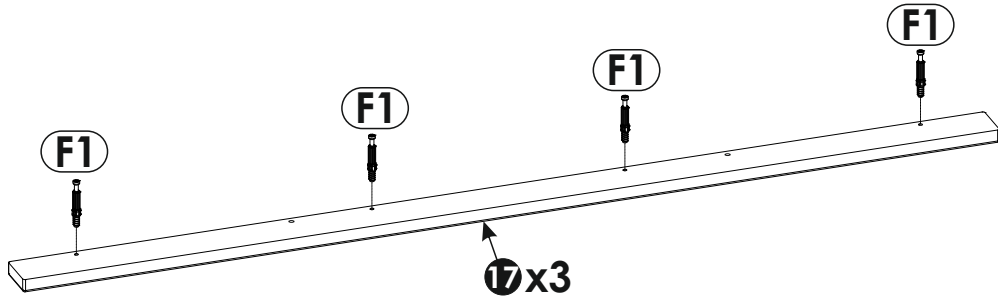
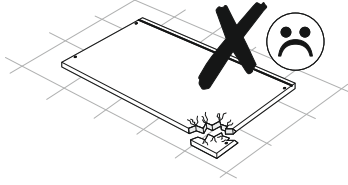
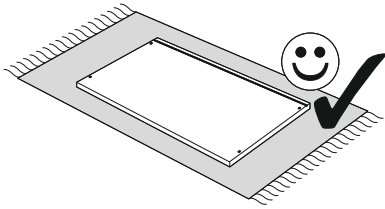

27 ▶

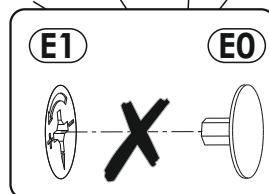
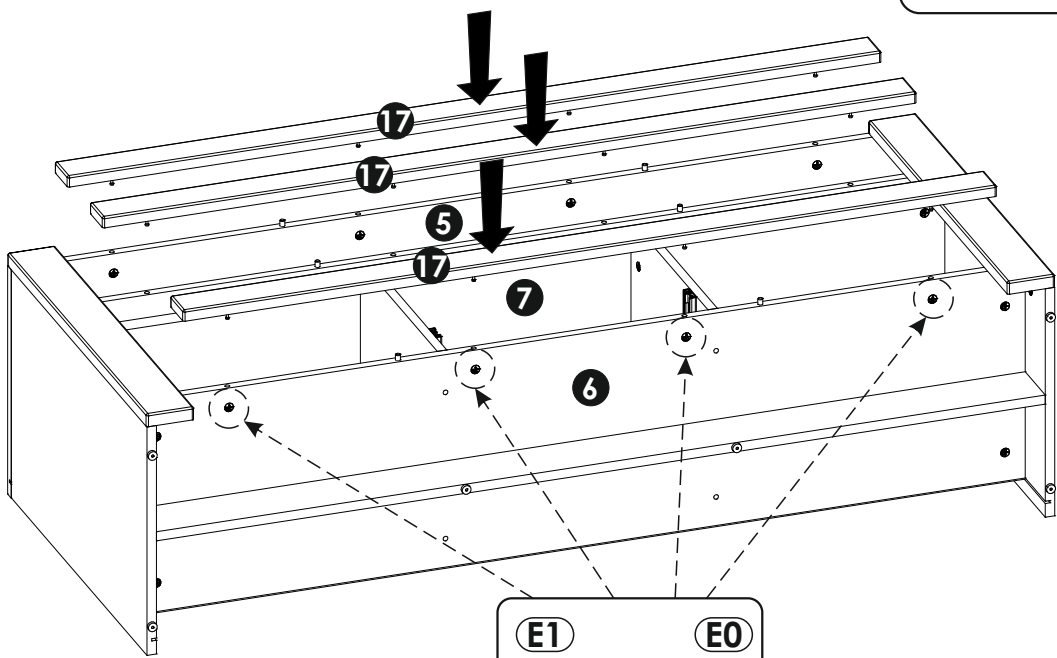
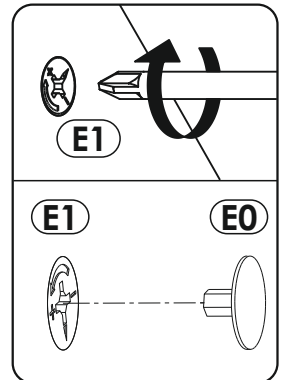
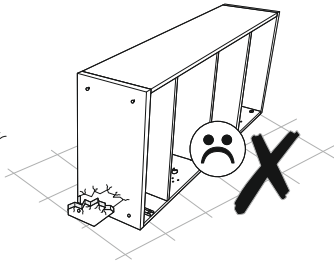
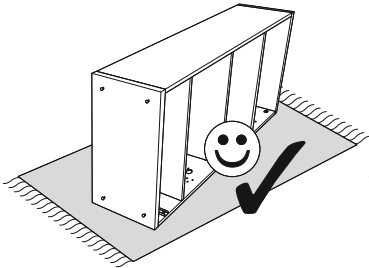

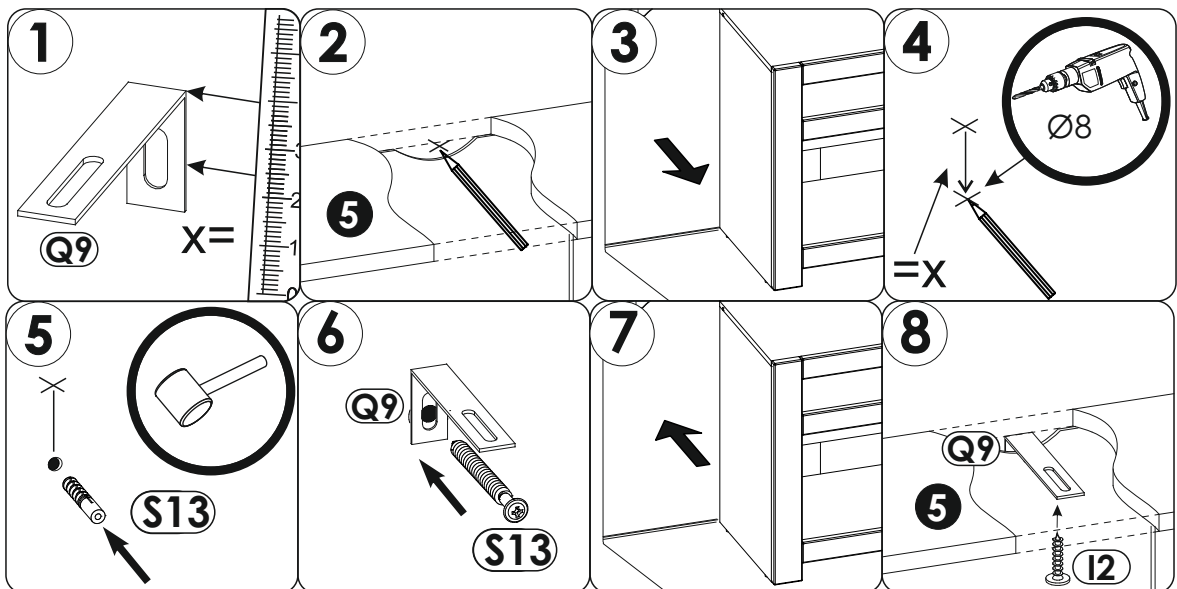
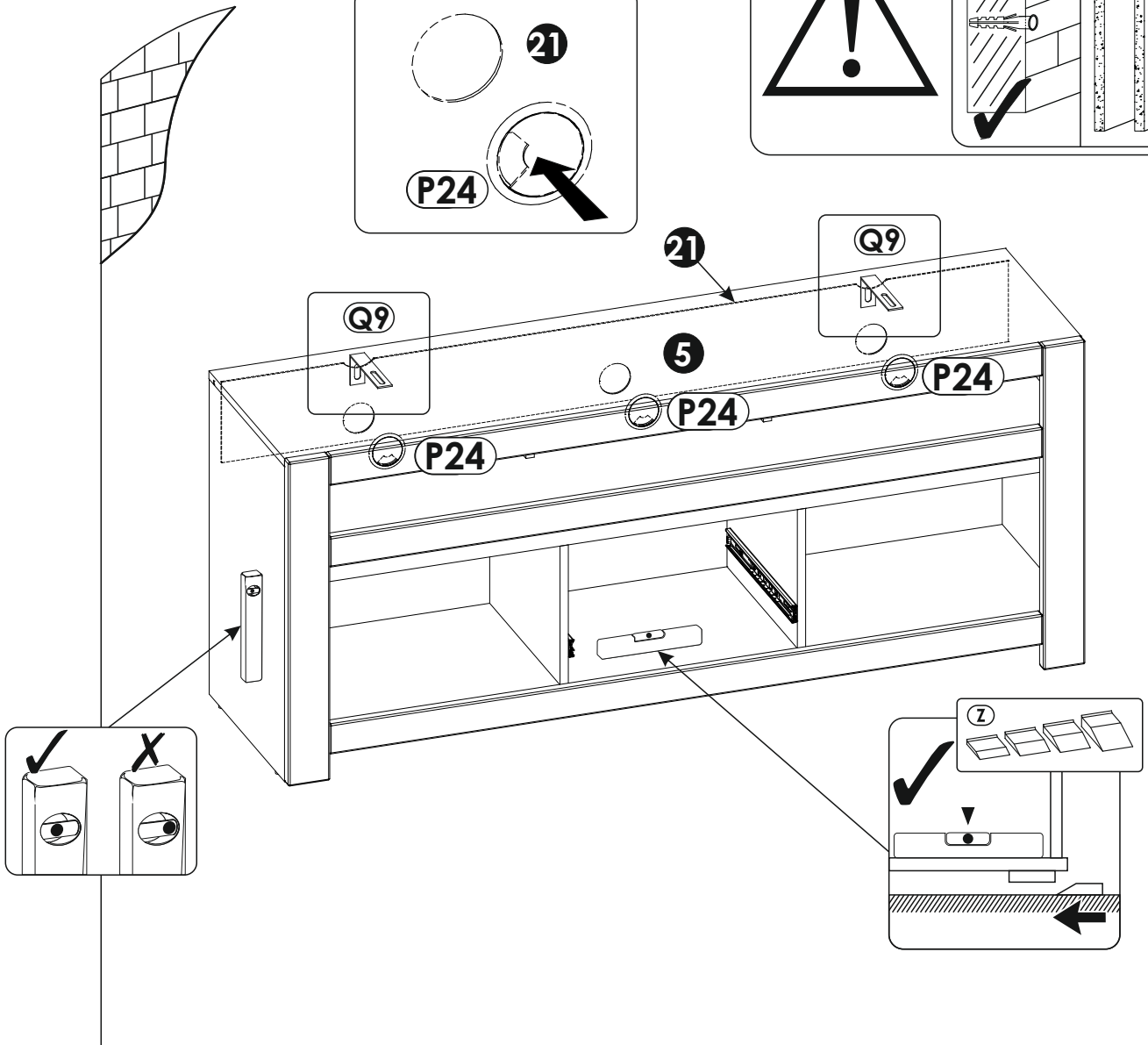
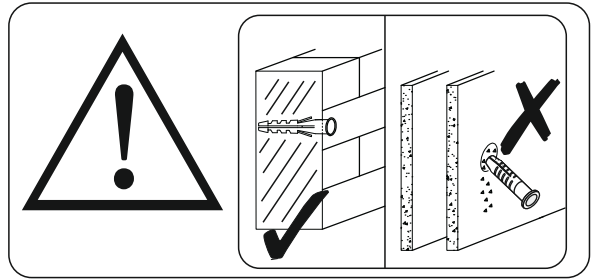

29 ▶

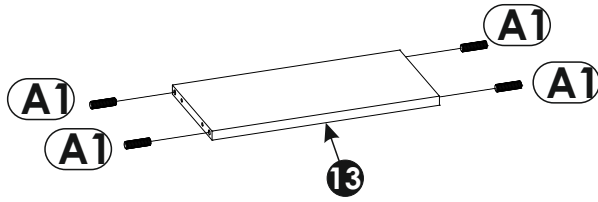
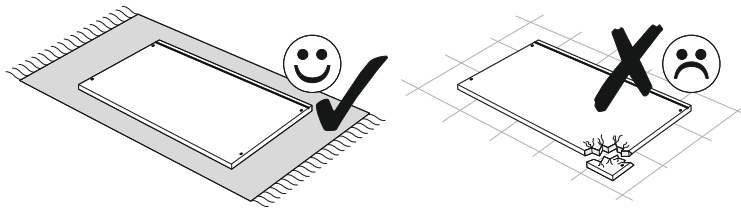

30 ▶

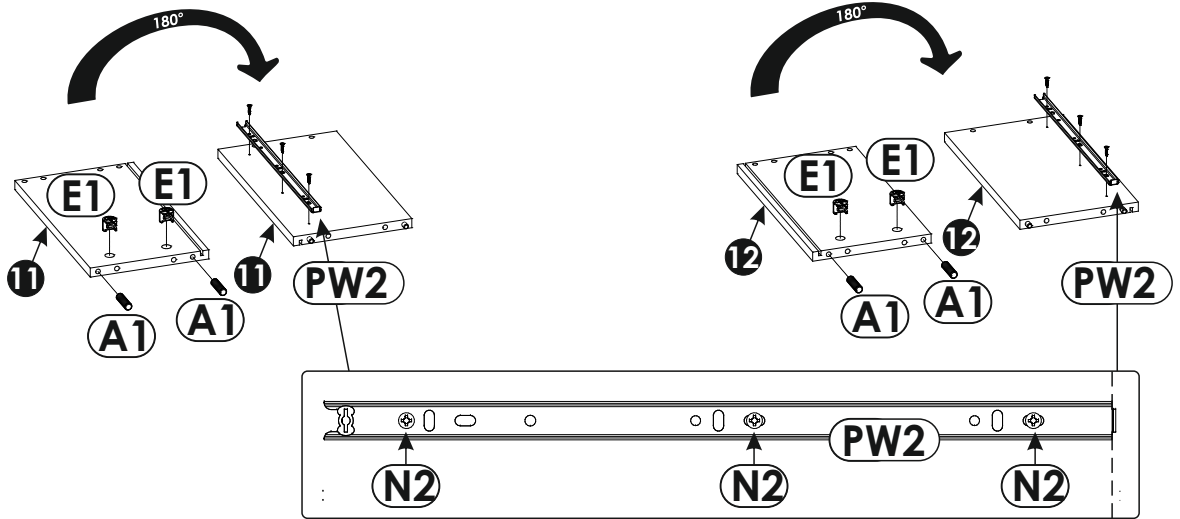
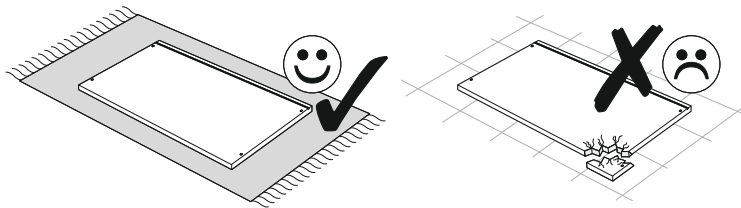

31 ▶

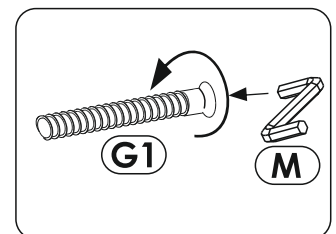
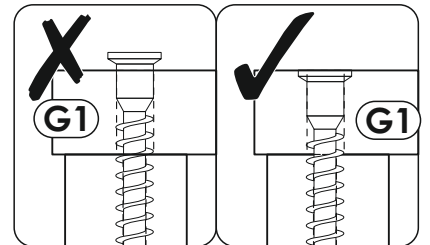
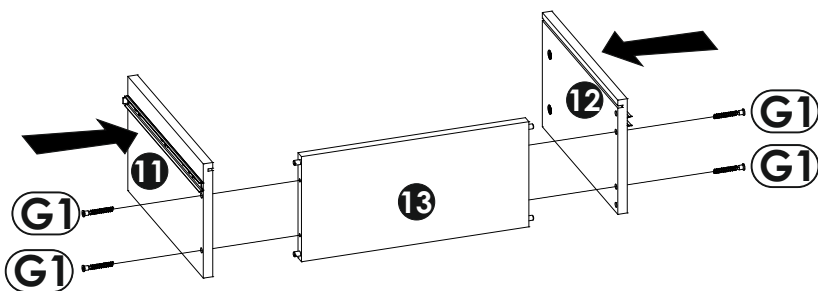
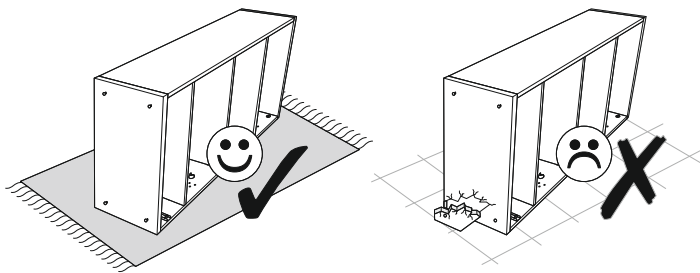

32 ▶

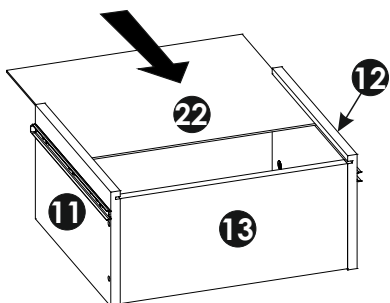
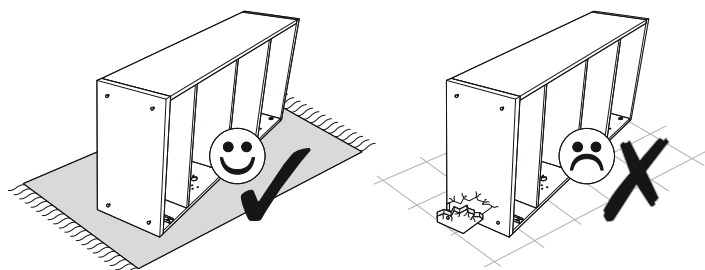

33 ▶

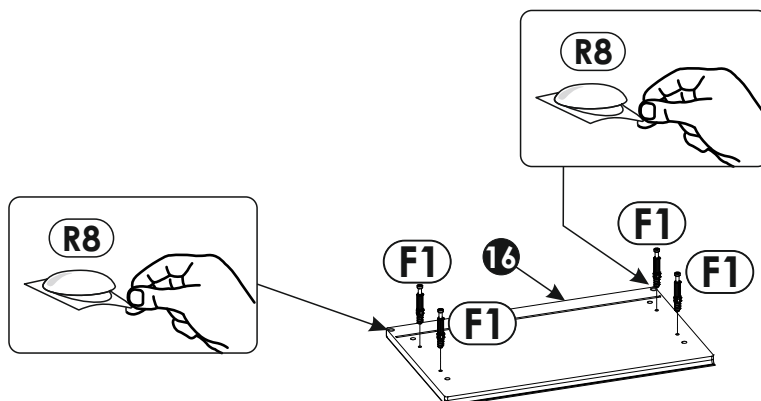
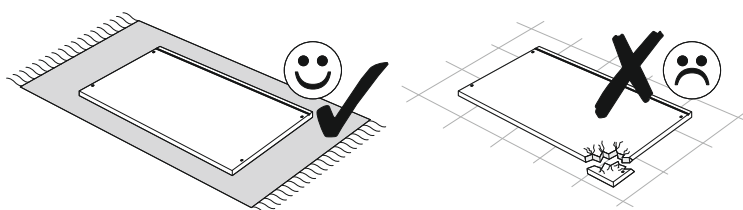

34 ▶

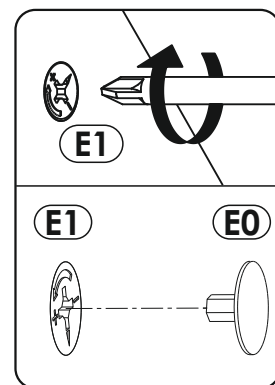
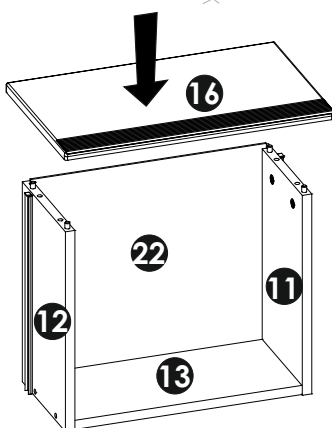
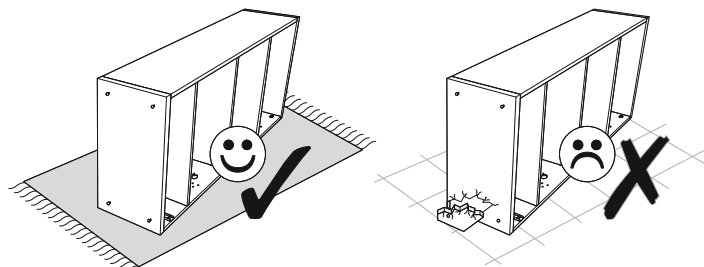

35 ▶

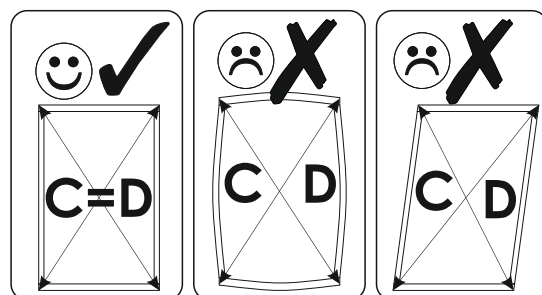
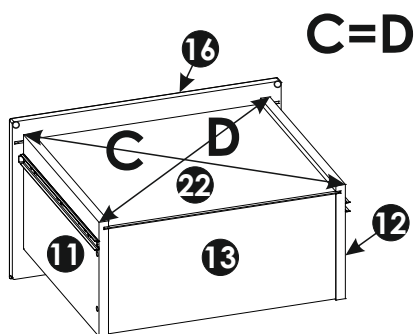
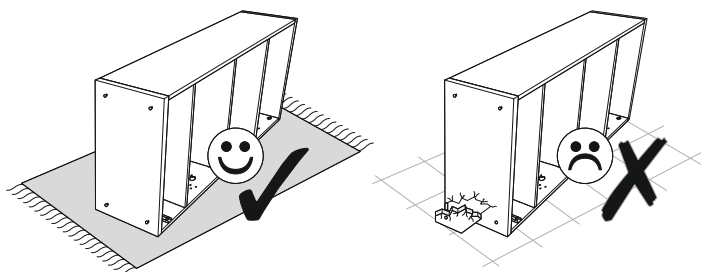

36 ▶

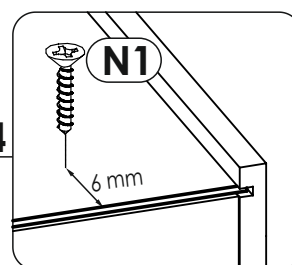
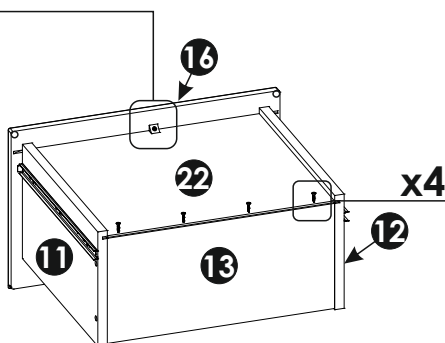
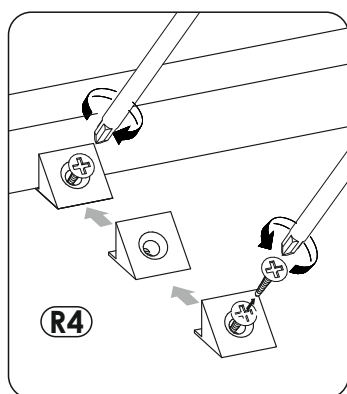
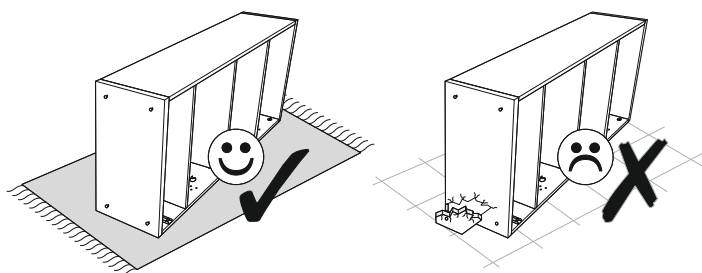

37 ▶

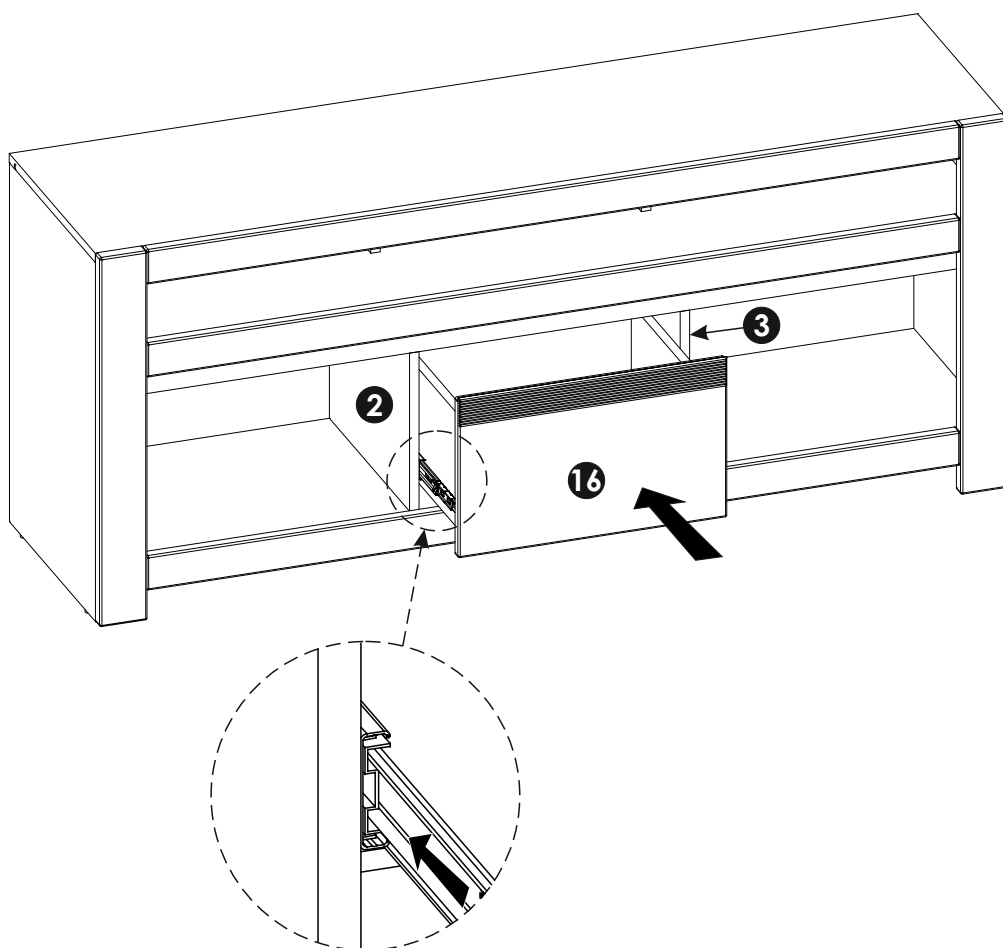

38 ▶

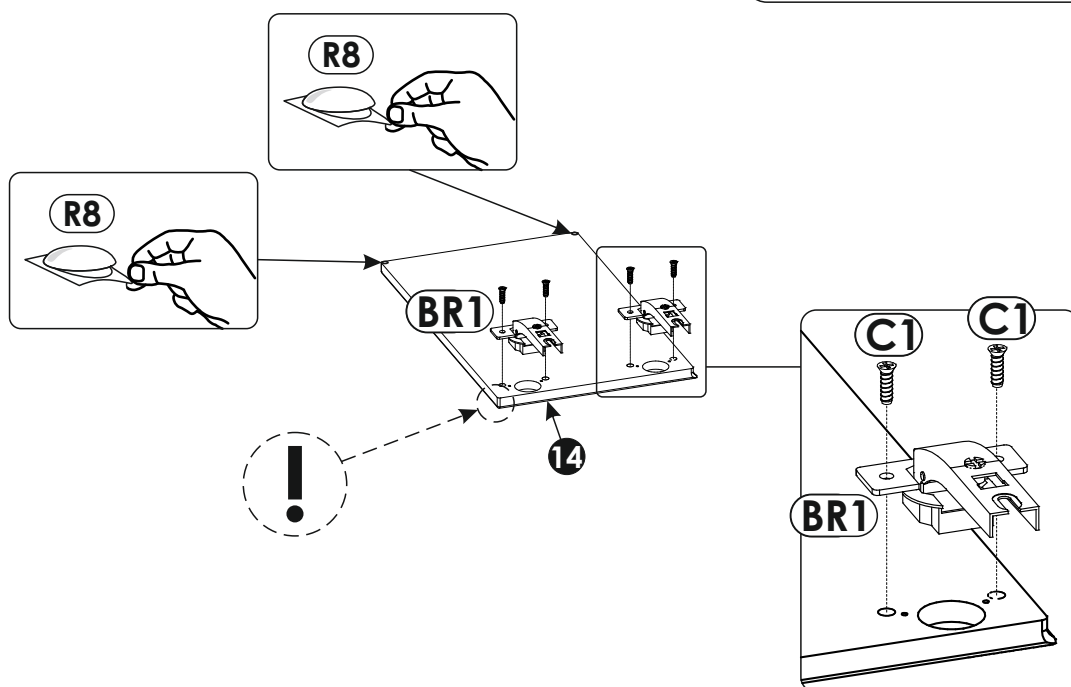
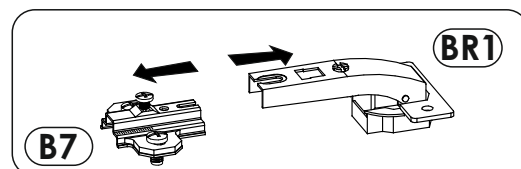
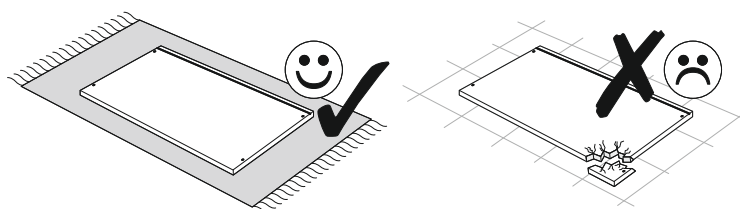



39 ▶

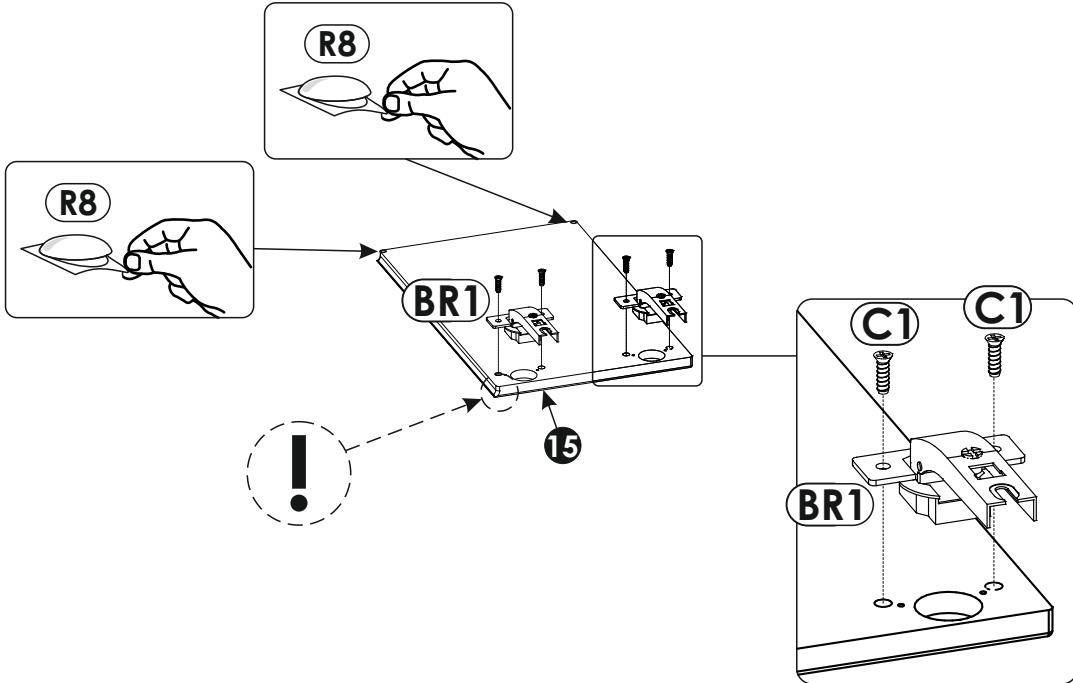
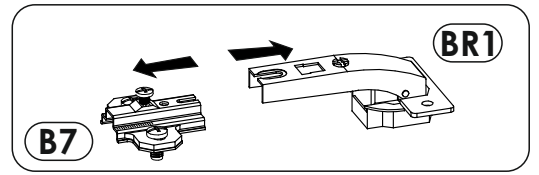
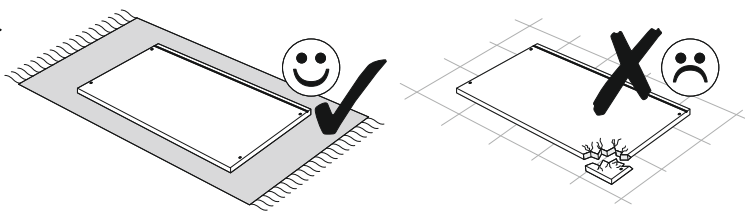

40 ▶

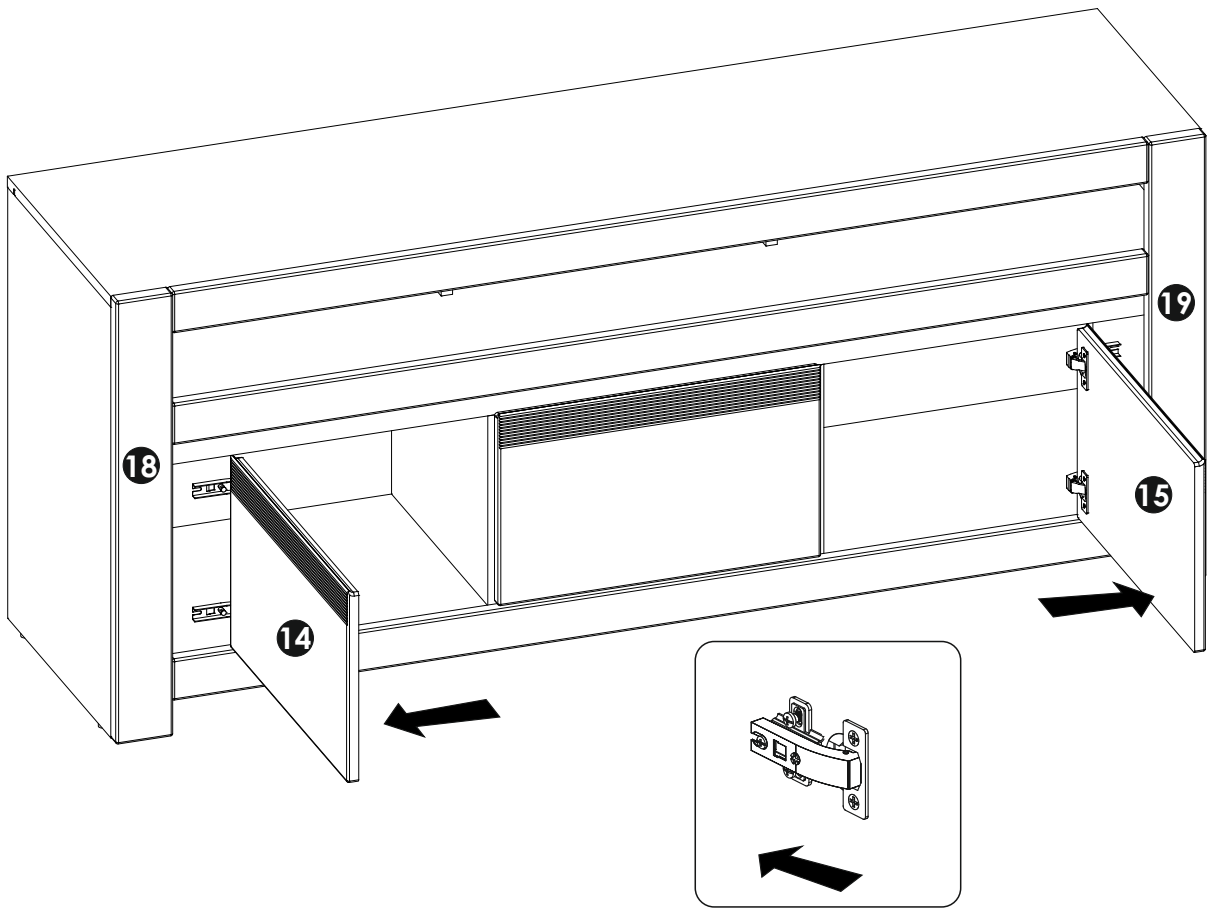

41 ▶

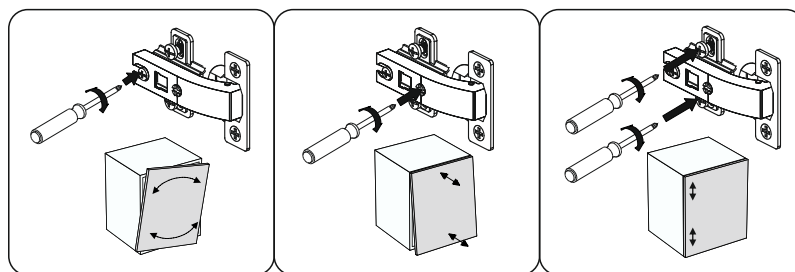
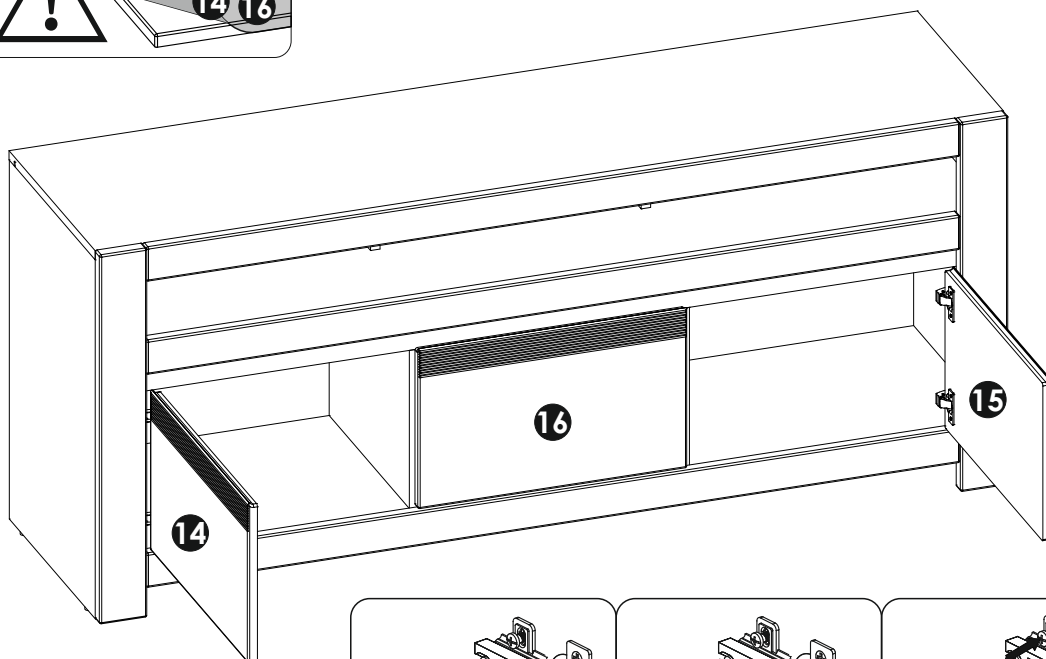
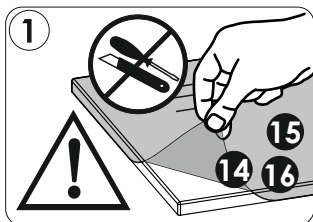

42 ▶

