

2023-09-26

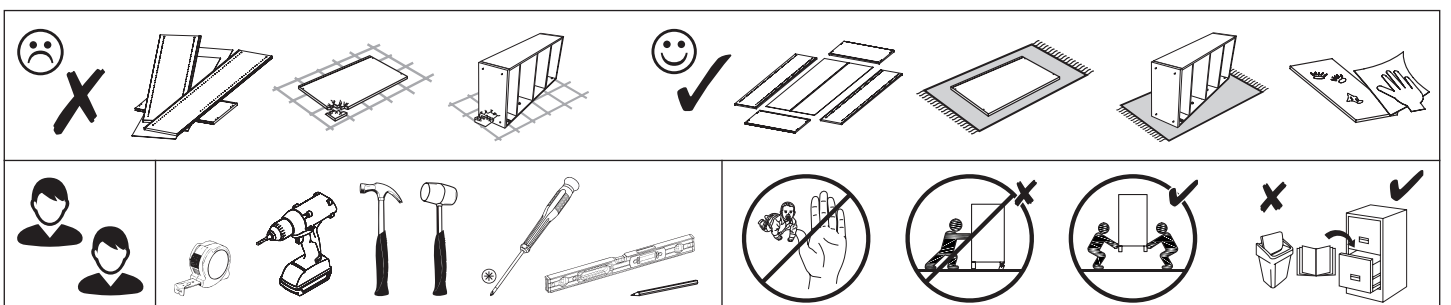

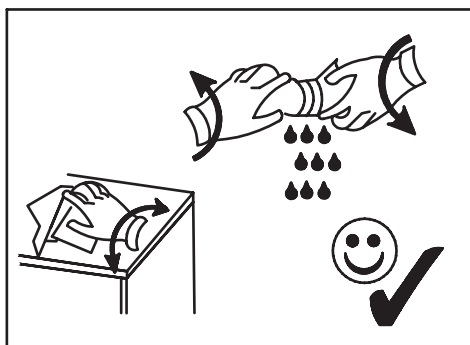

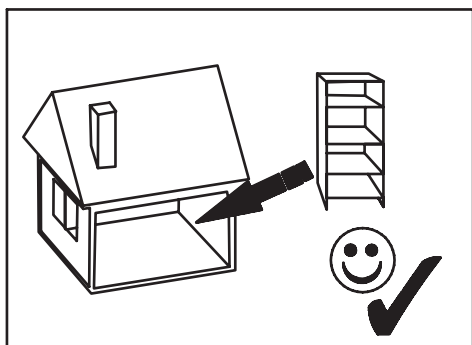
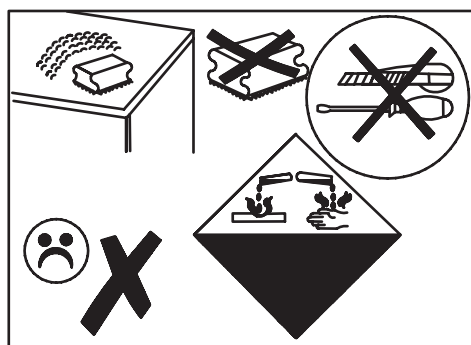
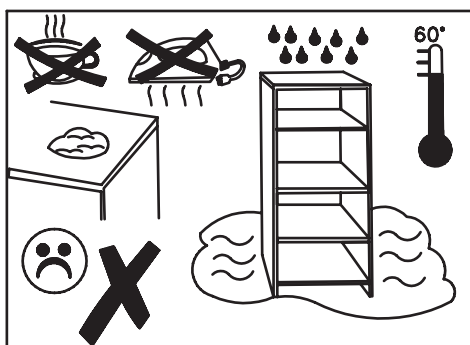
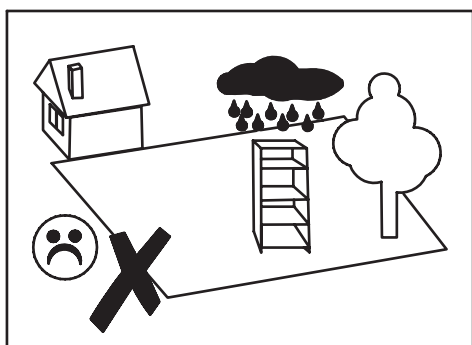
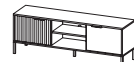
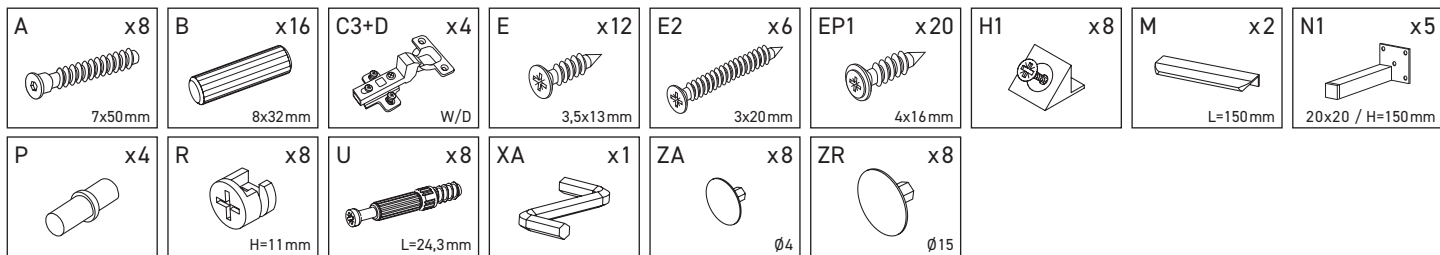
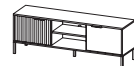

F-1	1531	395	16	x1	1/1
F-2	1531	395	16	x1	1/1
F-3	352	394	16	x1	1/1
F-4	352	394	16	x1	1/1
F-5	352	347	16	x1	1/1
F-6	352	347	16	x1	1/1
F-7	482	335	16	x1	1/1
F-8	496	346	18	x1	1/1
F-9	496	346	16	x1	1/1
F-10	1512	366	3	x1	1/1

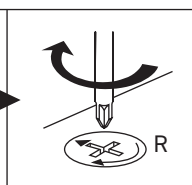
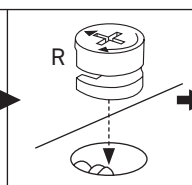
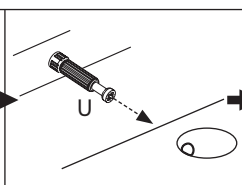
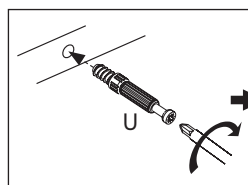
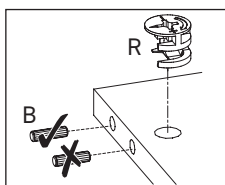
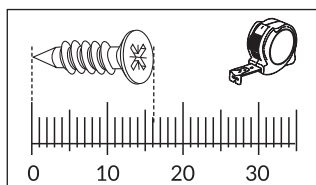
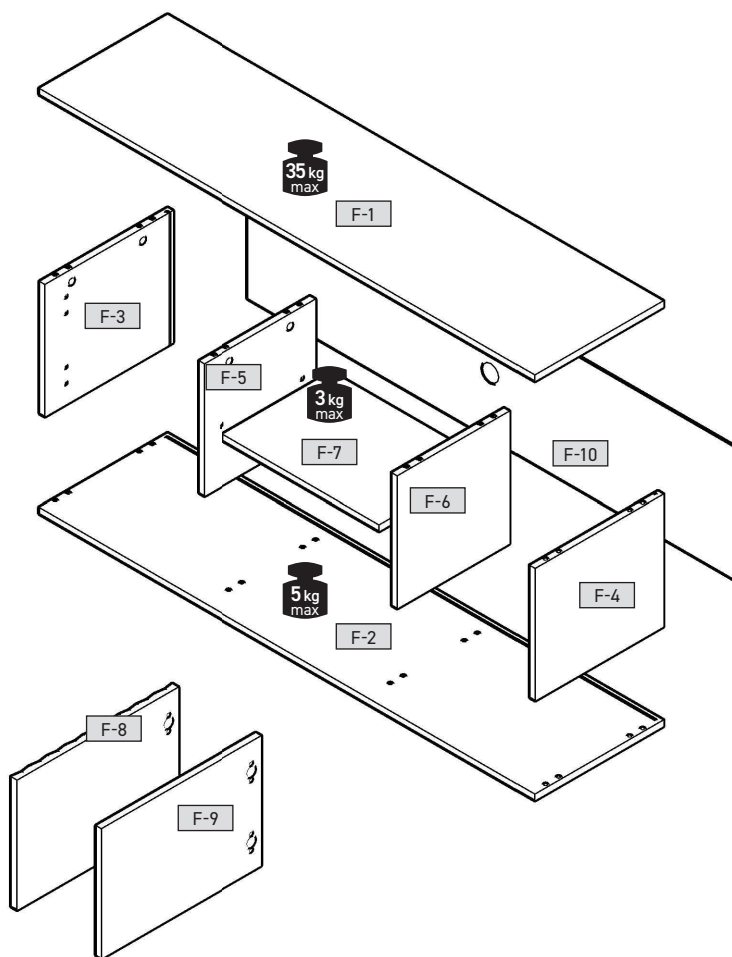

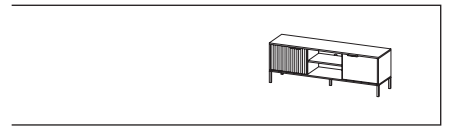

1

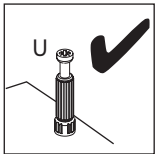
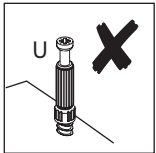
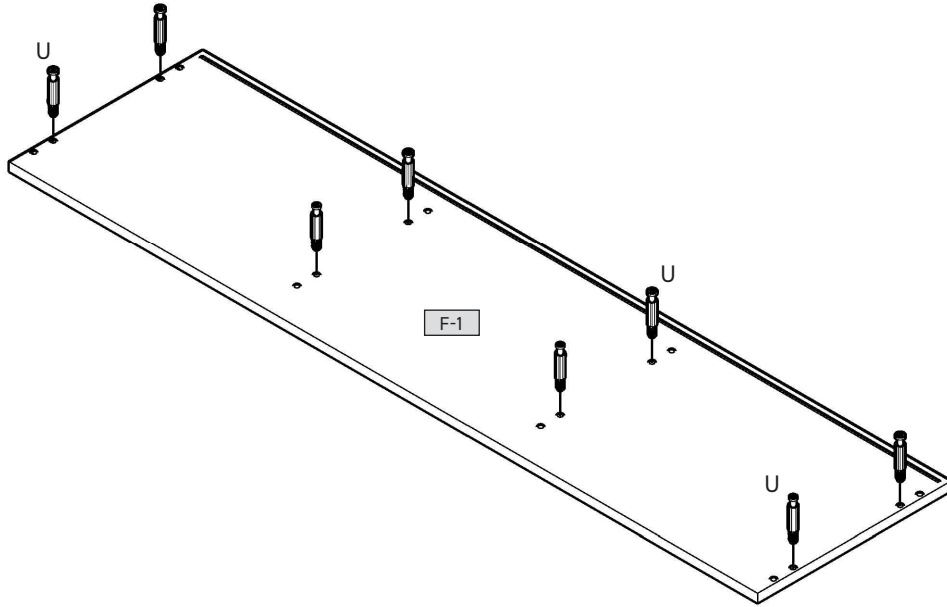
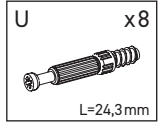

2

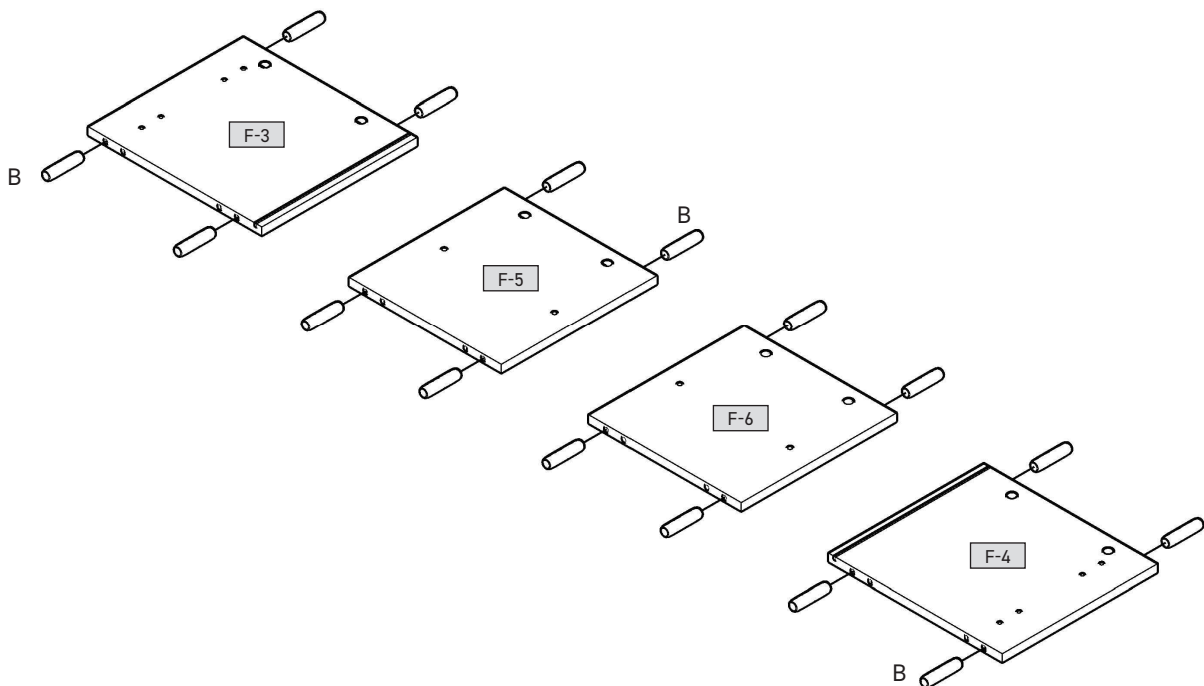
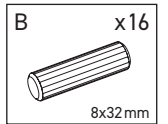



3

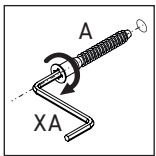
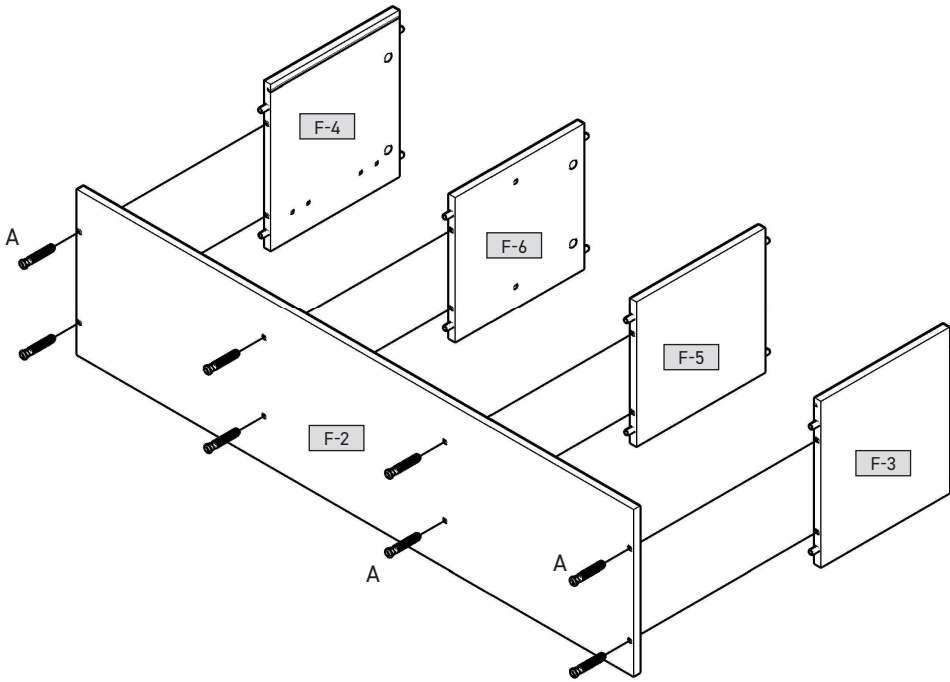
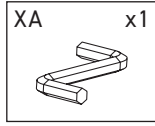
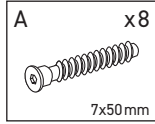

4

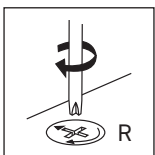
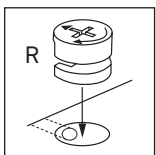
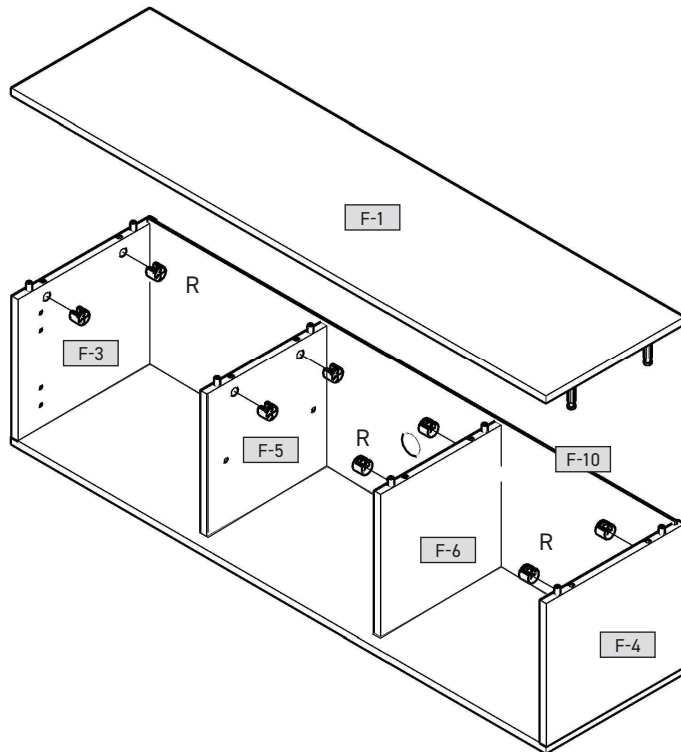
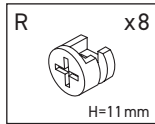

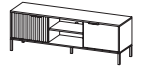

5

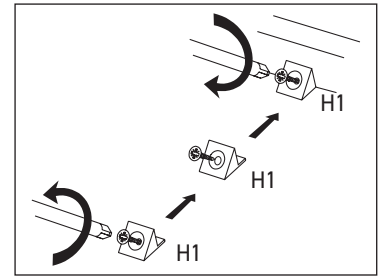
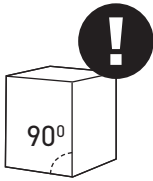
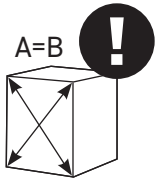
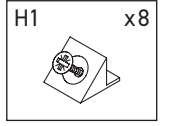
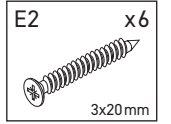
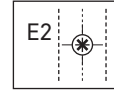
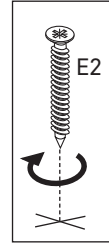
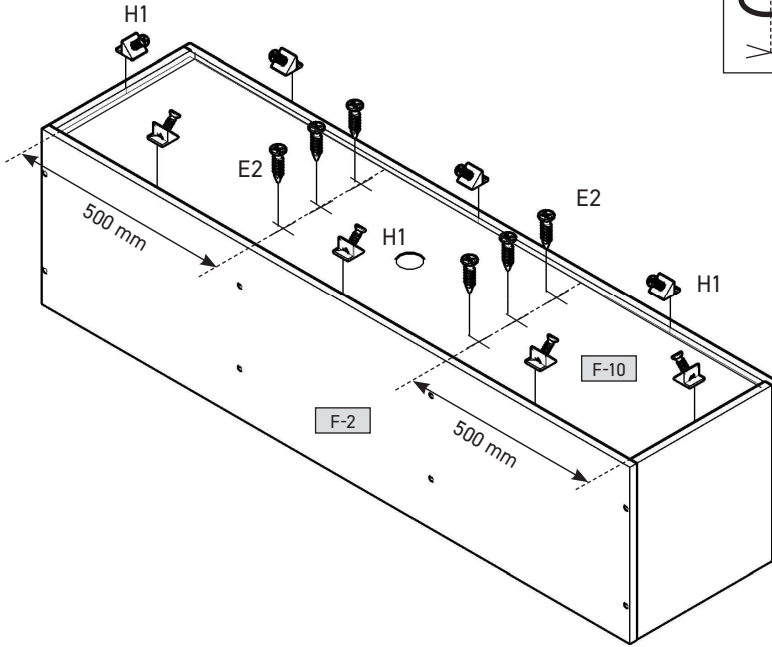

6

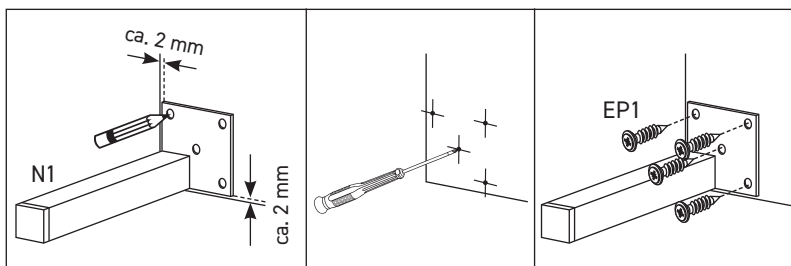
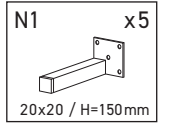
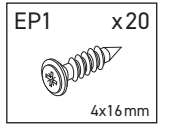
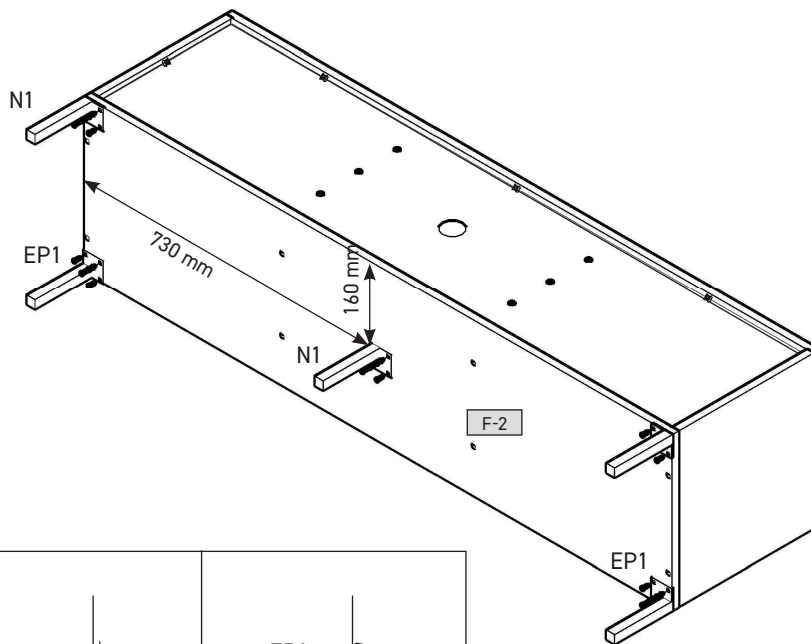

7

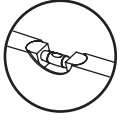

P x4

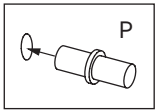
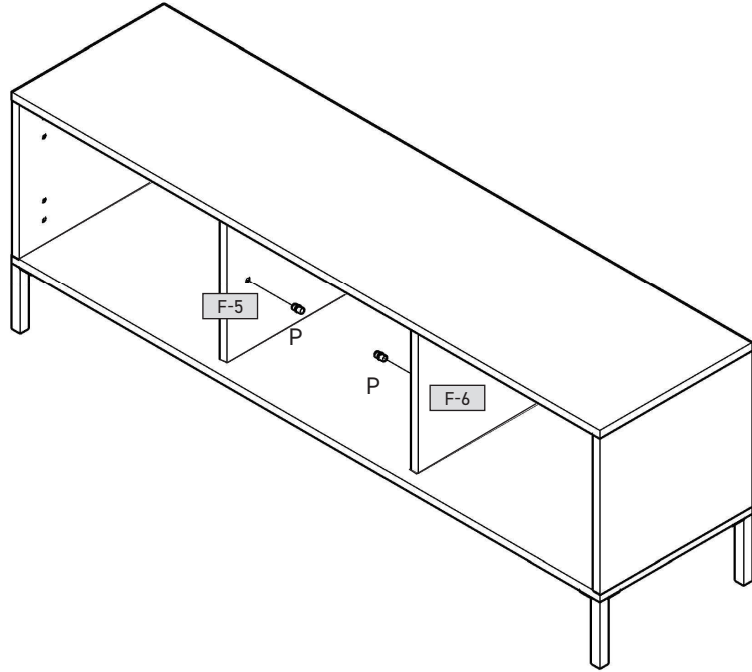
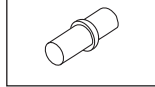

8



C3+D x4

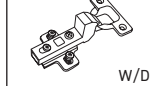

w/D

E x8

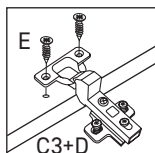
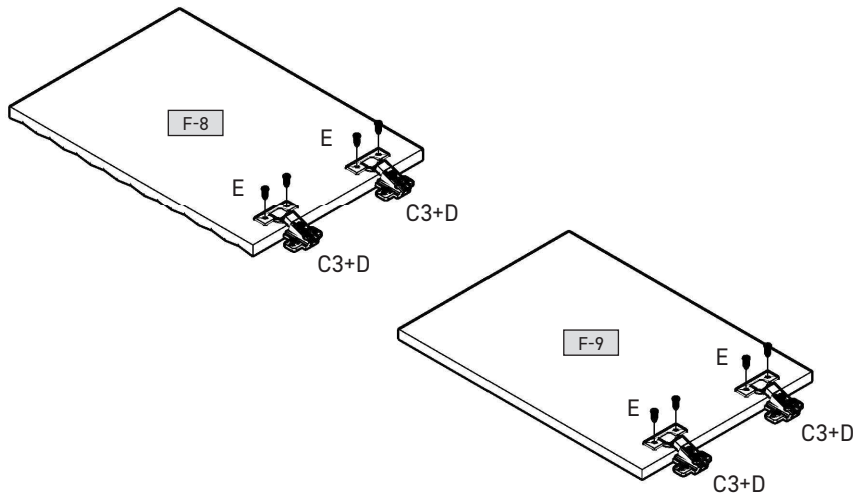
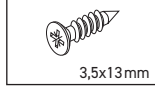

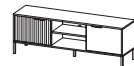

9

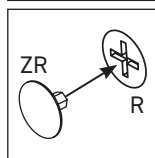
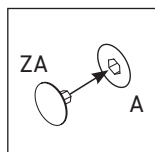
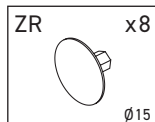
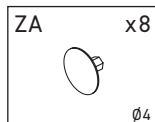
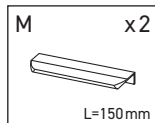
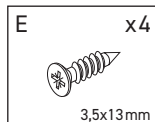
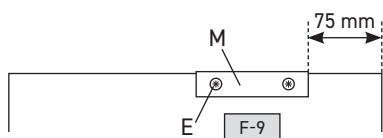
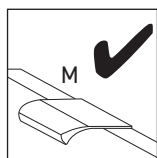
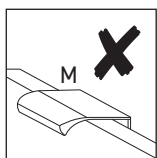
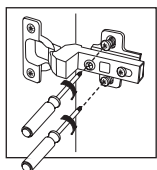
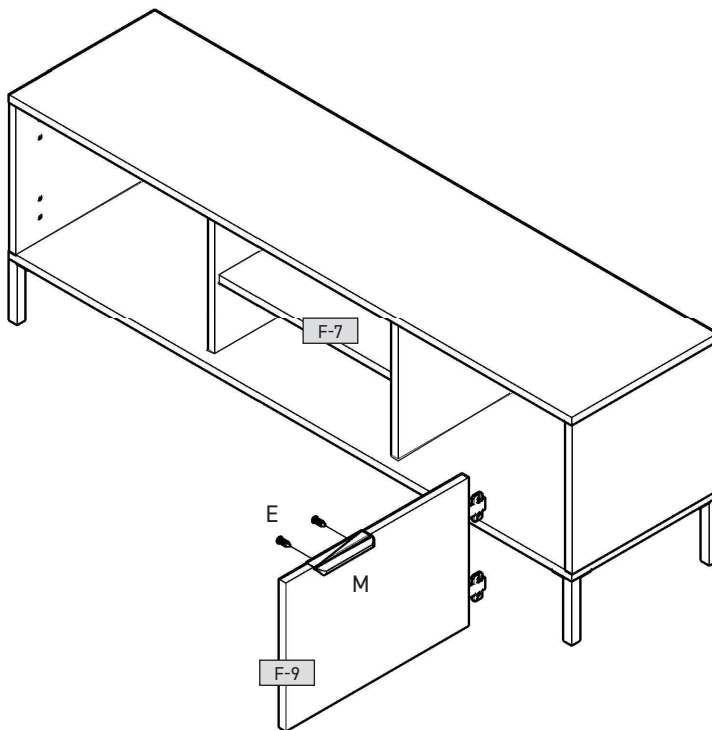
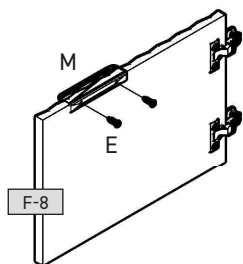
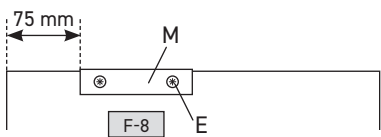

10

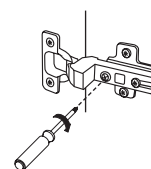
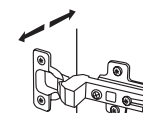
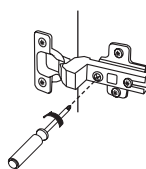
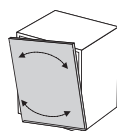
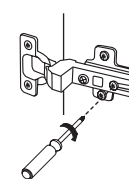
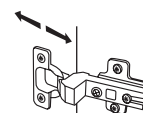
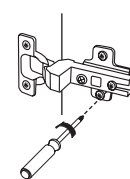
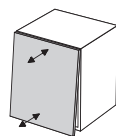
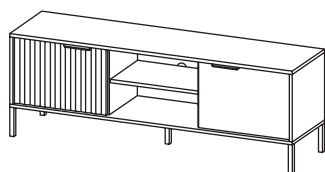
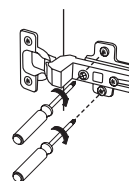
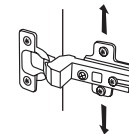
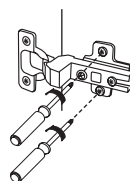
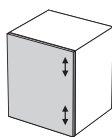

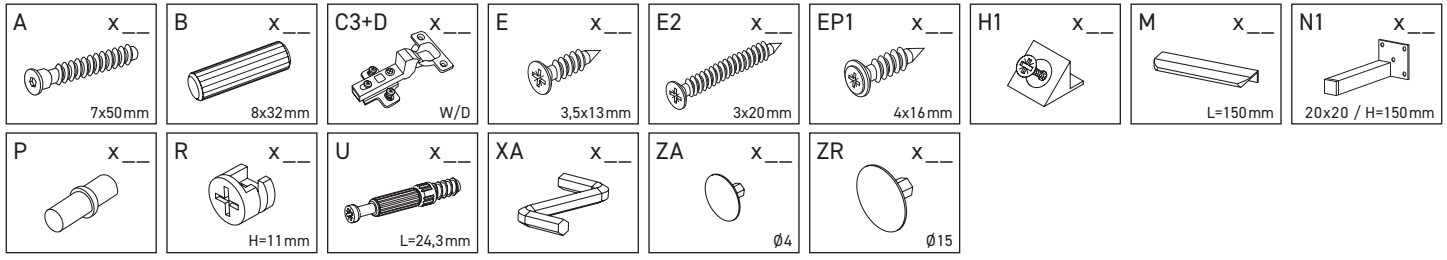

F-1	1531	395	16	x 1	1/1
F-2	1531	395	16	x 1	1/1
F-3	352	394	16	x 1	1/1
F-4	352	394	16	x 1	1/1
F-5	352	347	16	x 1	1/1
F-6	352	347	16	x 1	1/1
F-7	482	335	16	x 1	1/1
F-8	496	346	18	x 1	1/1
F-9	496	346	16	x 1	1/1
F-10	1512	366	3	x 1	1/1

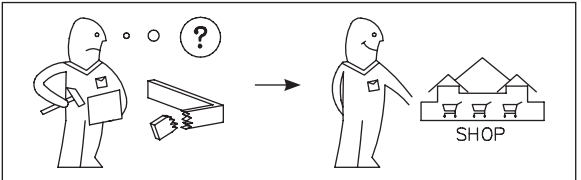
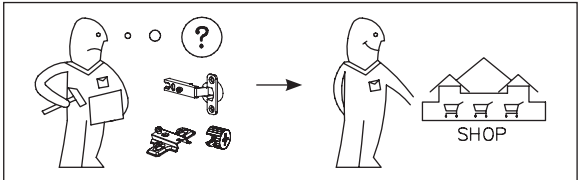
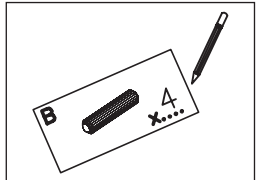
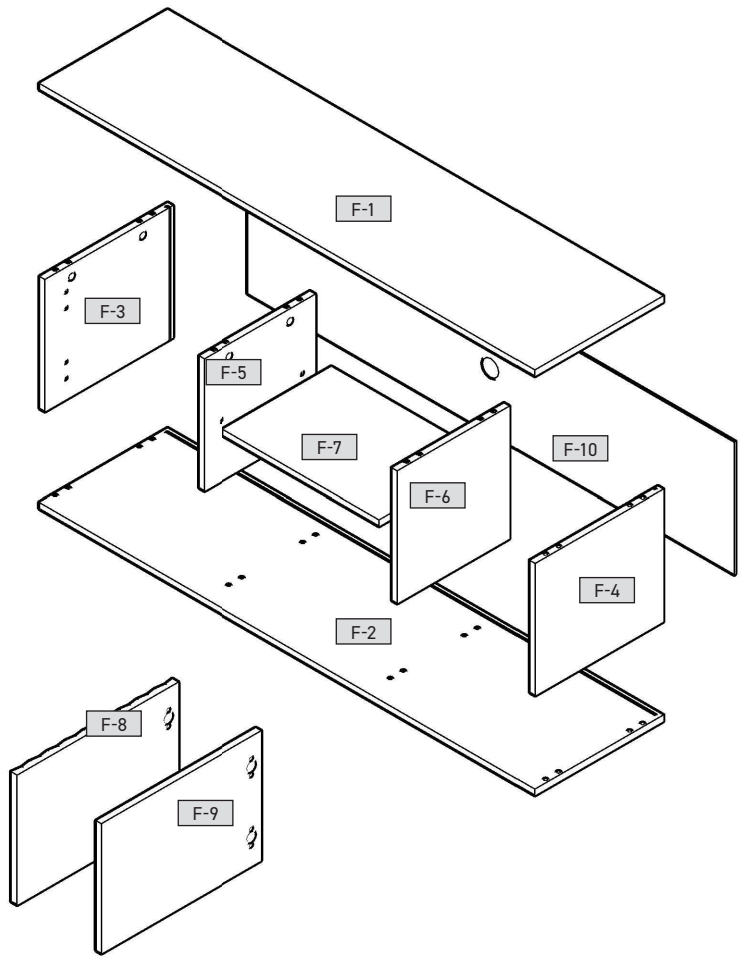

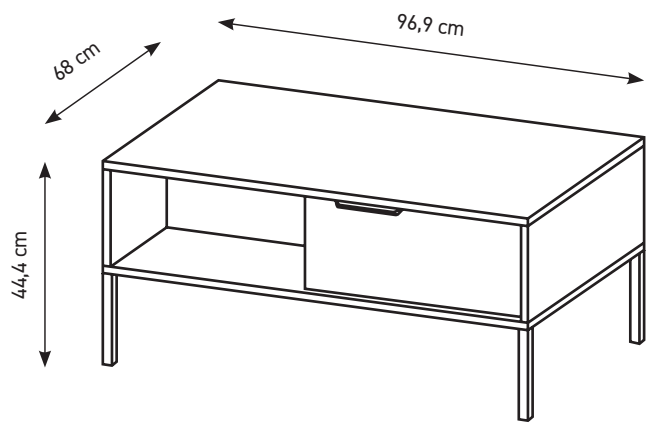

2023-04-27

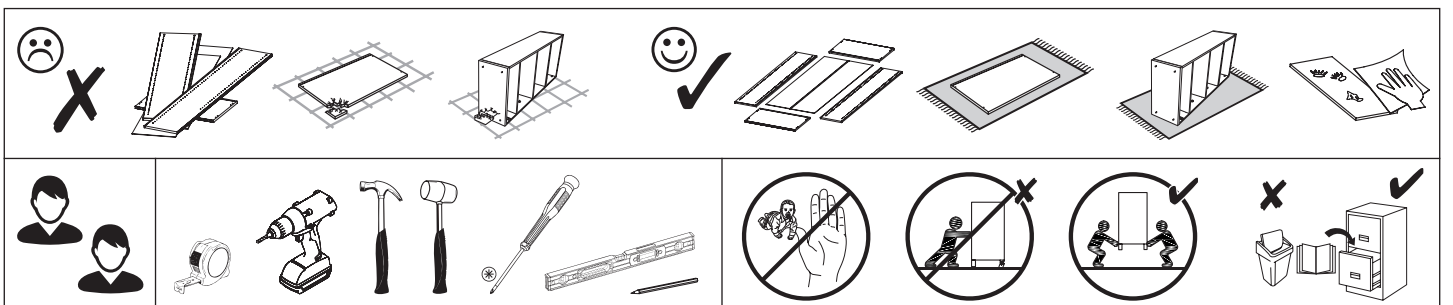



kontaktujte špecialistu. Montáž musí byť vykonaná kompetentnou osobou.

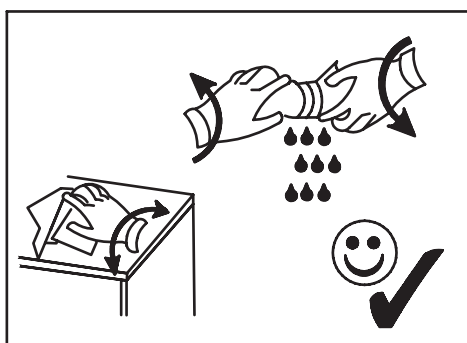
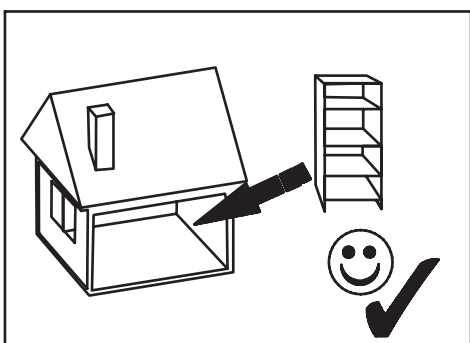
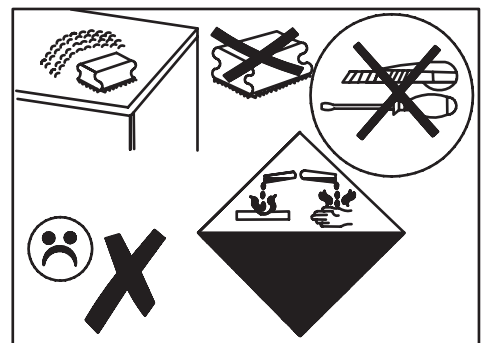
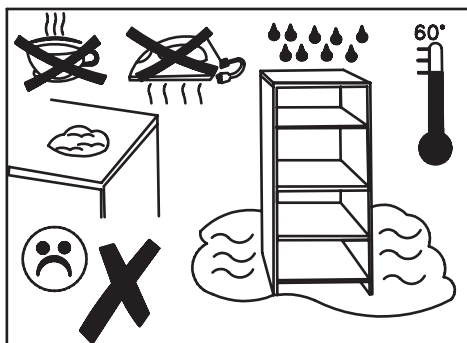
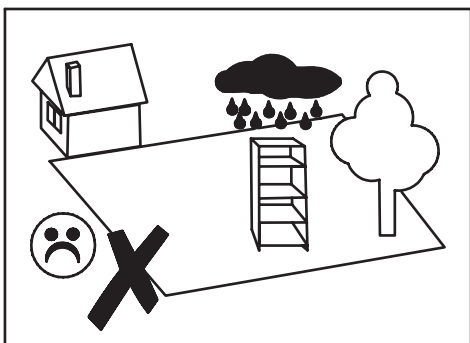

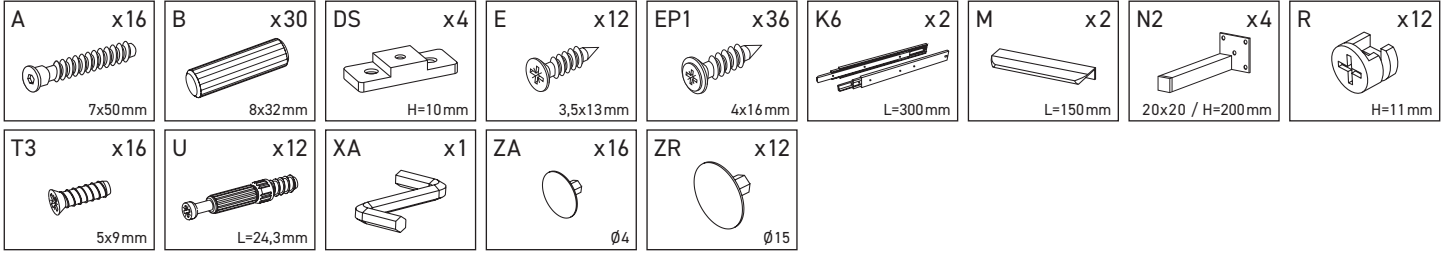

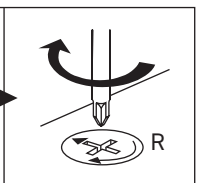
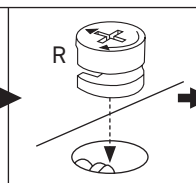
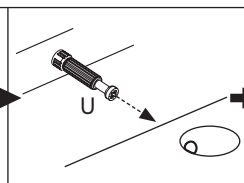
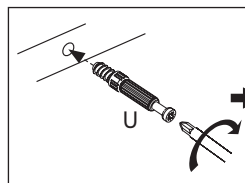
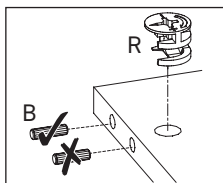
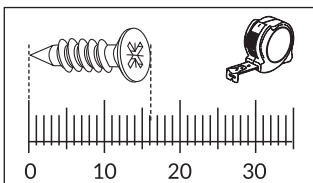
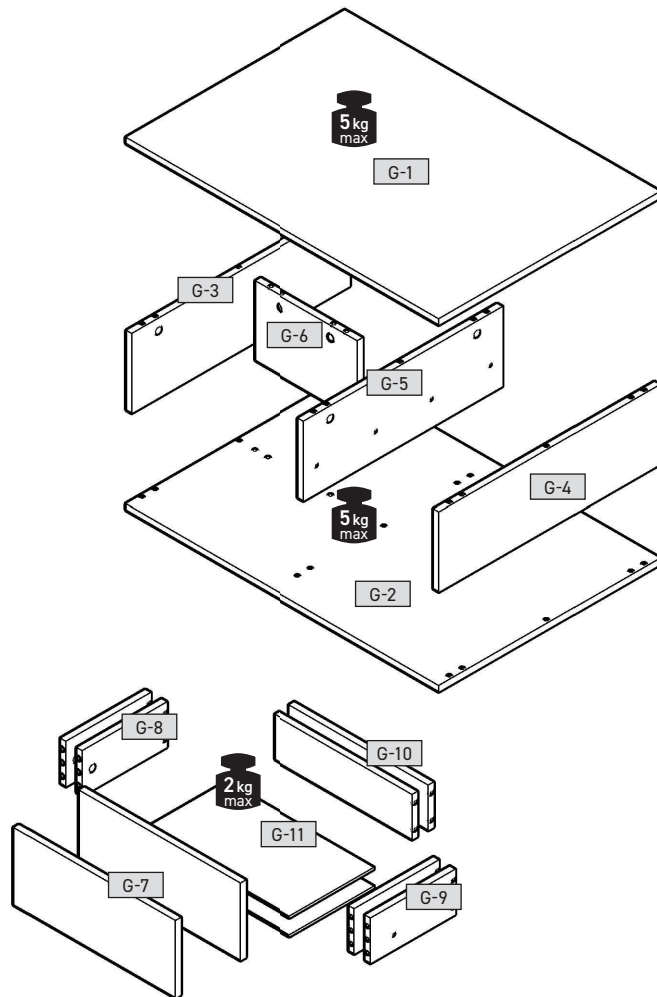

G-1	969	680	16	x 1	1/1
G-2	969	680	16	x 1	1/1
G-3	212	678	16	x 1	1/1
G-4	212	678	16	x 1	1/1
G-5	212	614	16	x 1	1/1
G-6	212	320	16	x 1	1/1
G-7	496	206	16	x 2	1/1
G-8	300	120	16	x 2	1/1
G-9	300	120	16	x 2	1/1
G-10	426	120	16	x 2	1/1
G-11	456	306	3	x 2	1/1





1

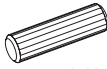
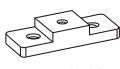

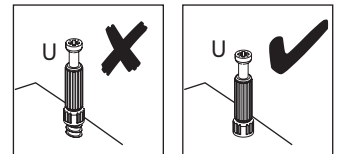
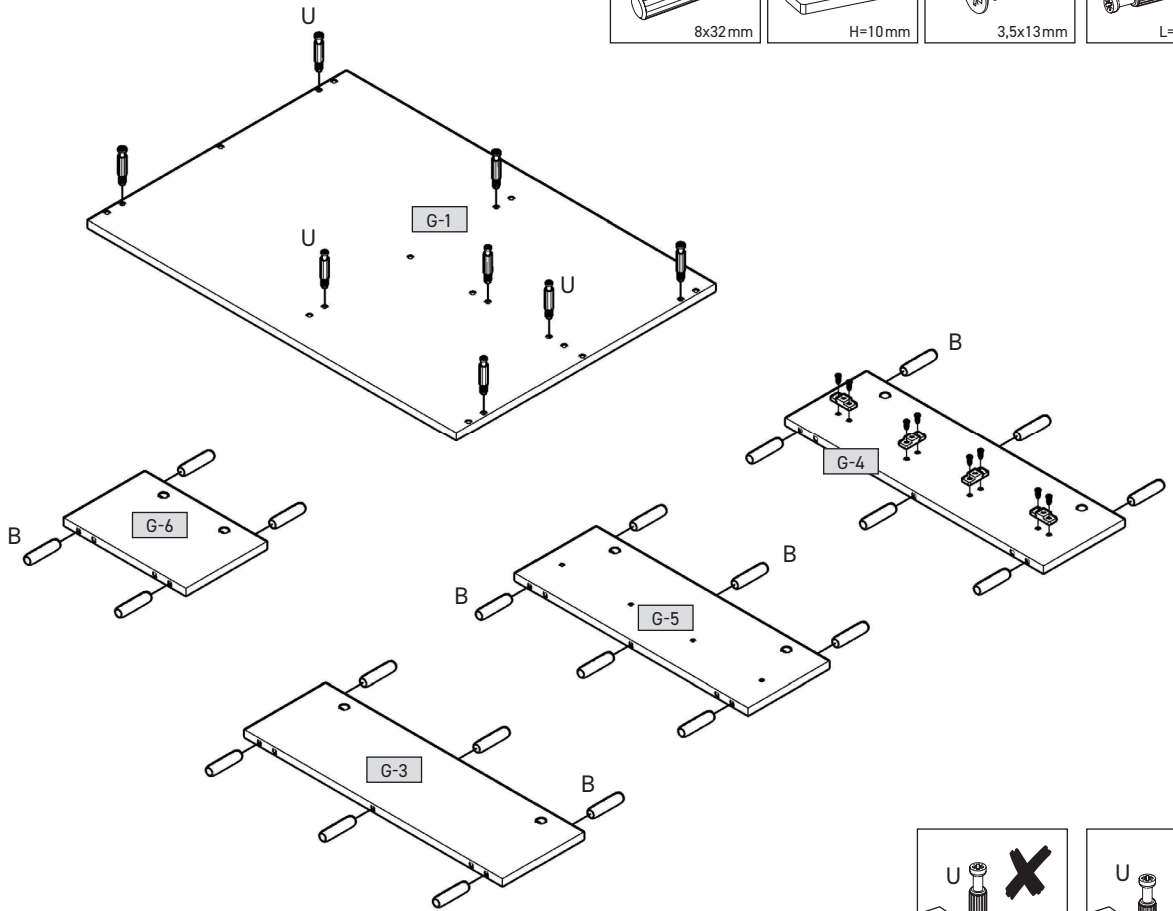

B x22  8x32mm	DS x4  H=10mm	E x8  3,5x13mm	U x8  L=24,3mm
--	---	--	--



2



K6 x2  L=250mm	T3 x8  5x9mm
--	--

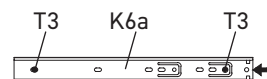
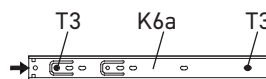
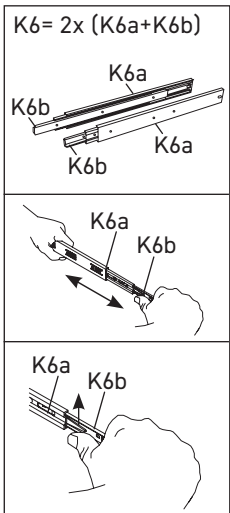
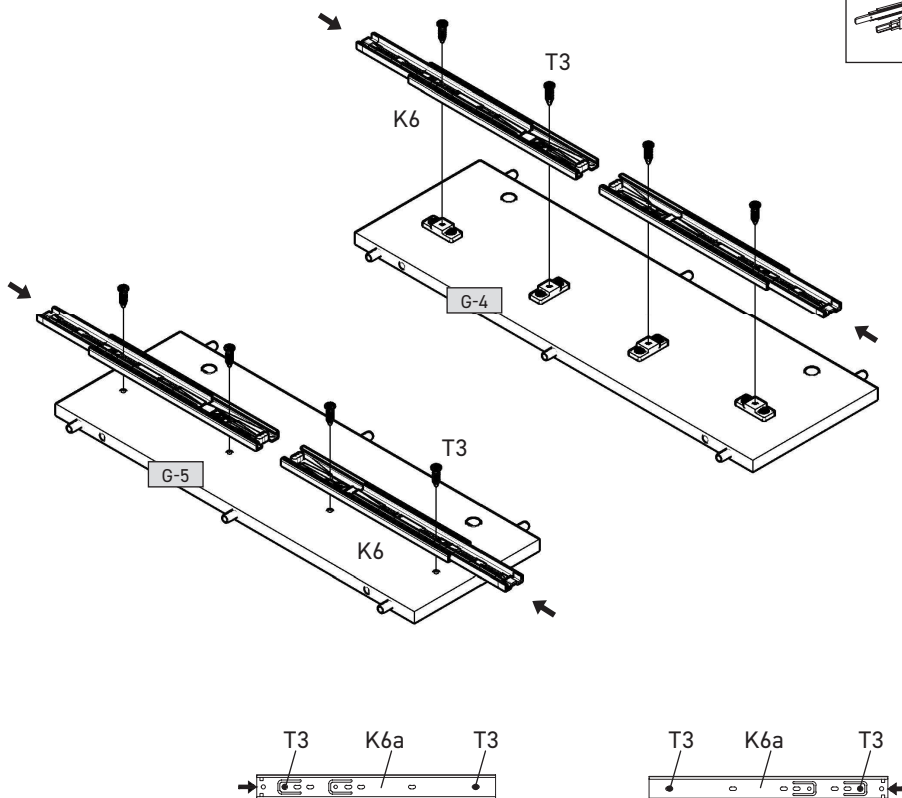



3

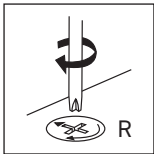
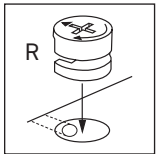
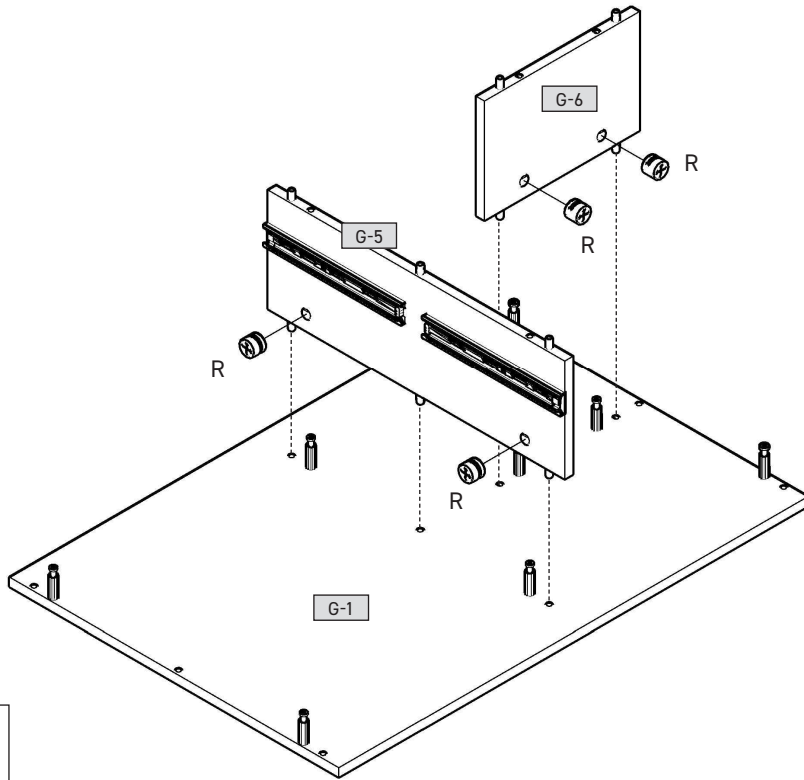
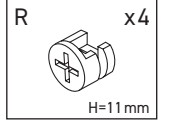

4

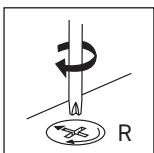
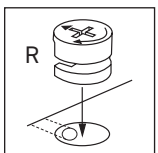
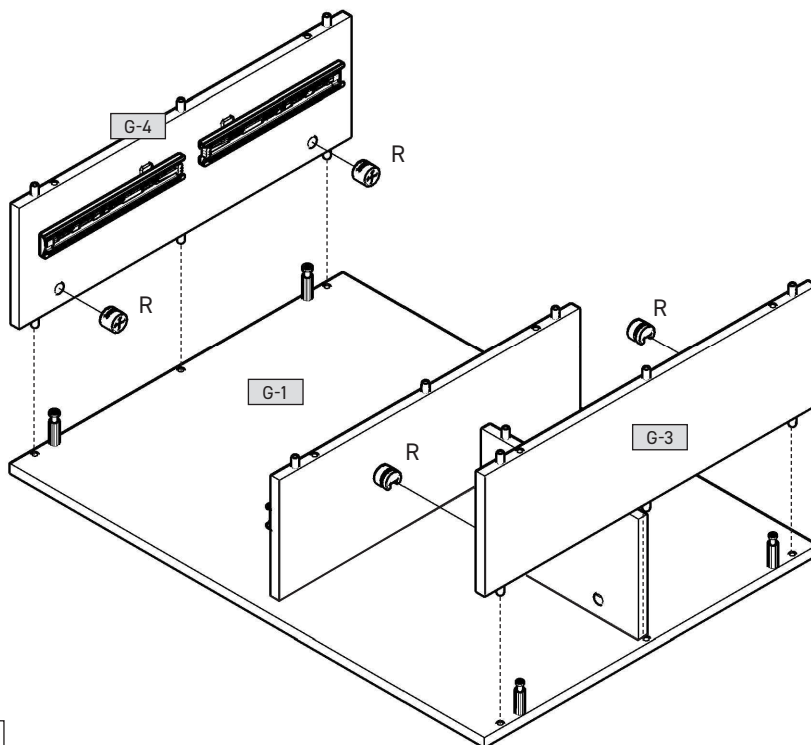
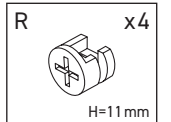



5

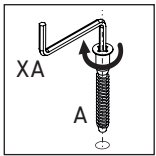
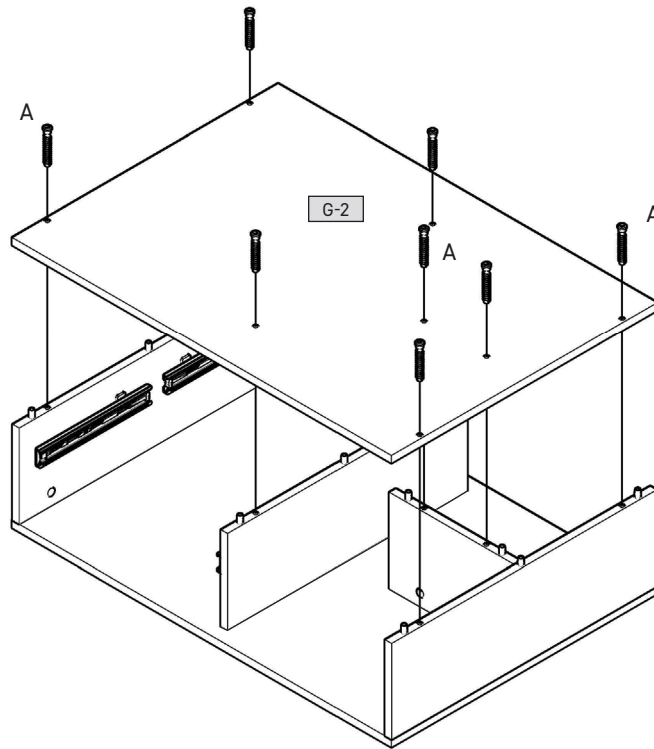
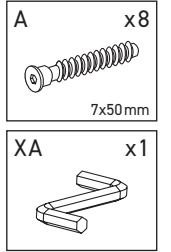

6

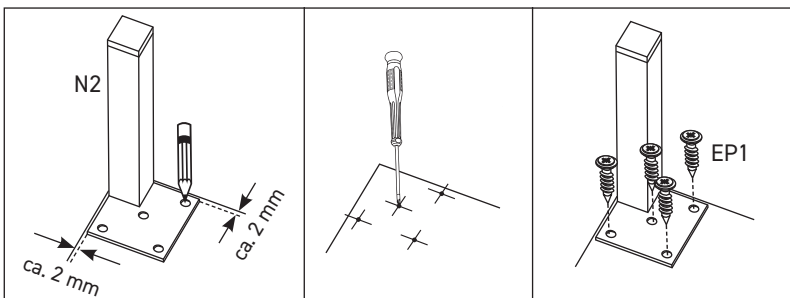
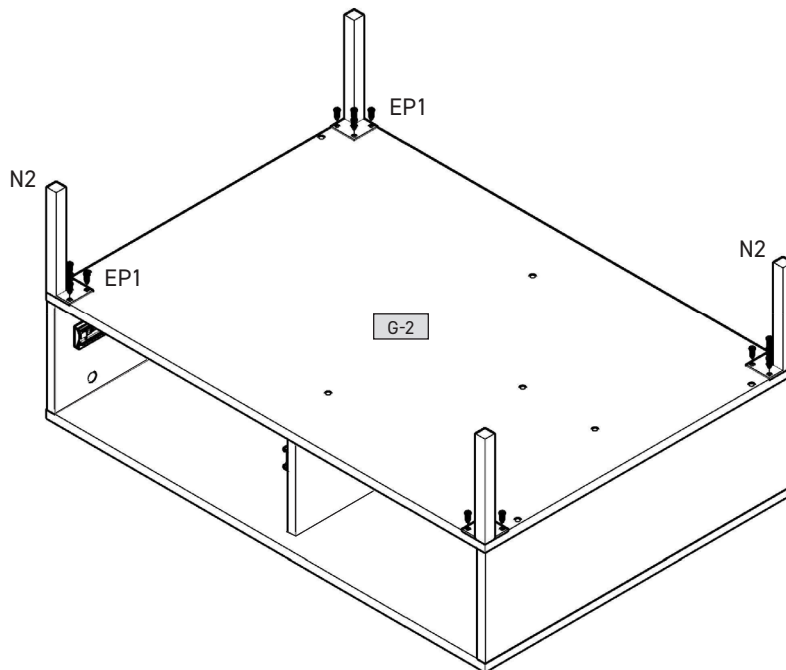
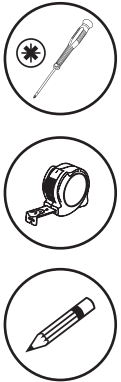
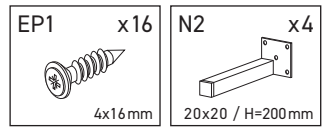



7

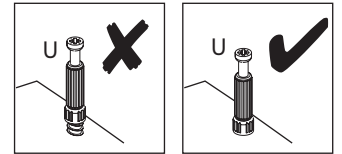
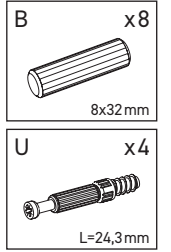
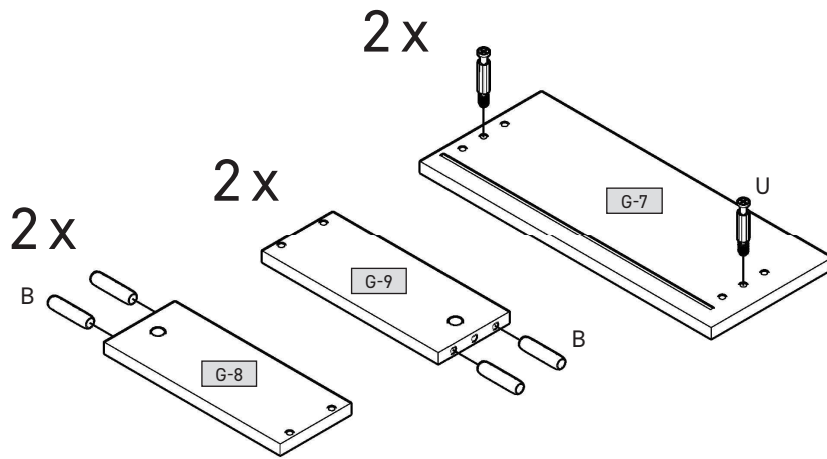

8

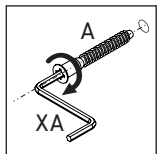
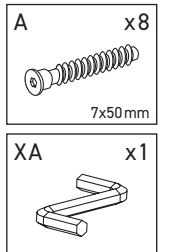
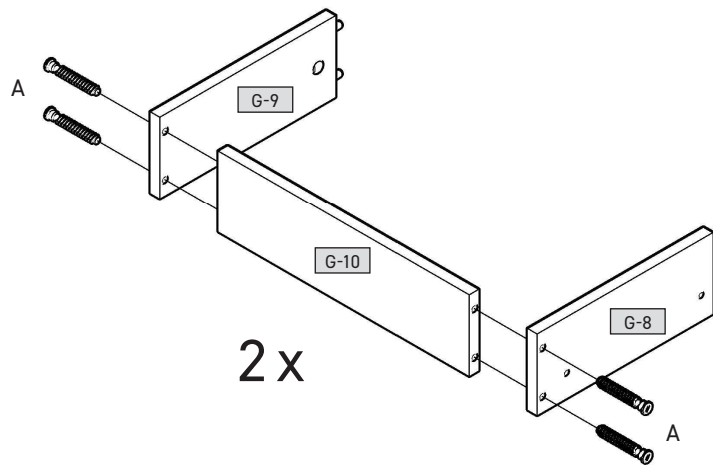

9

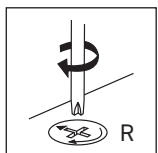
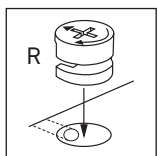
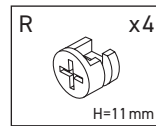
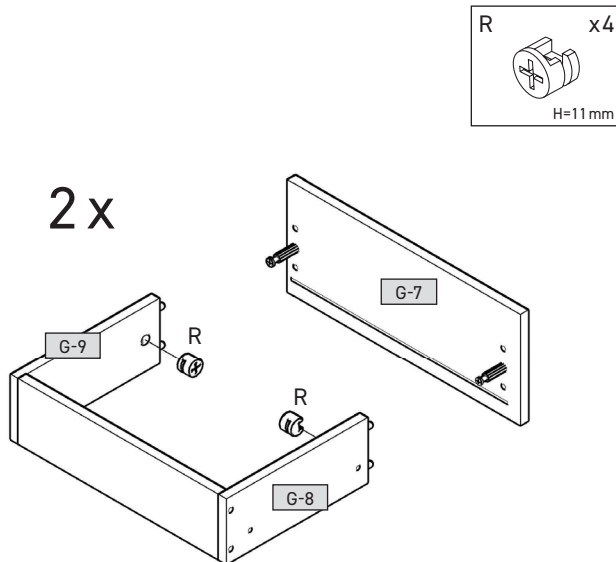

10

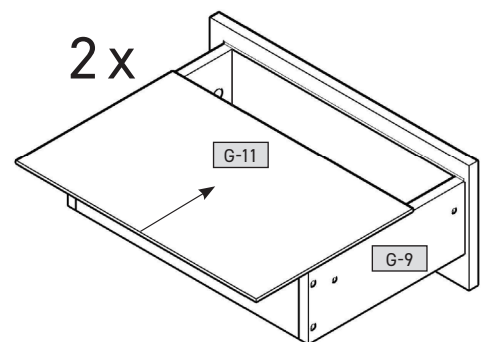



11

2x

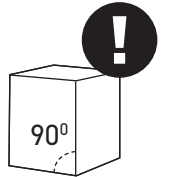
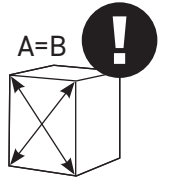
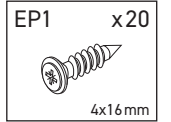
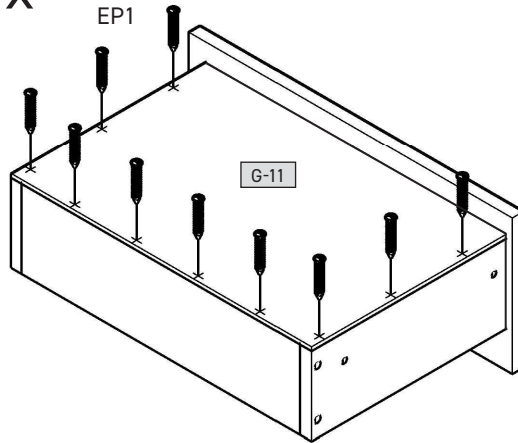
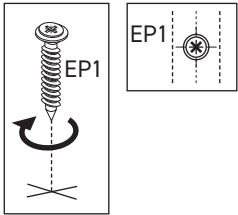
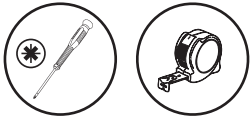

12

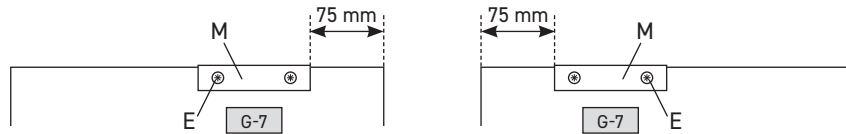
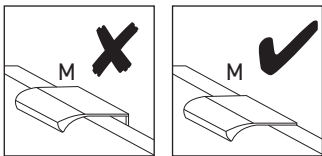
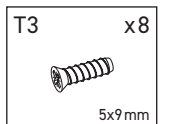
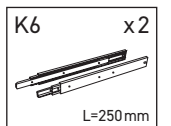
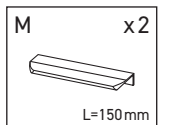
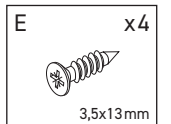
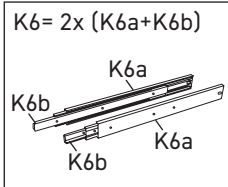
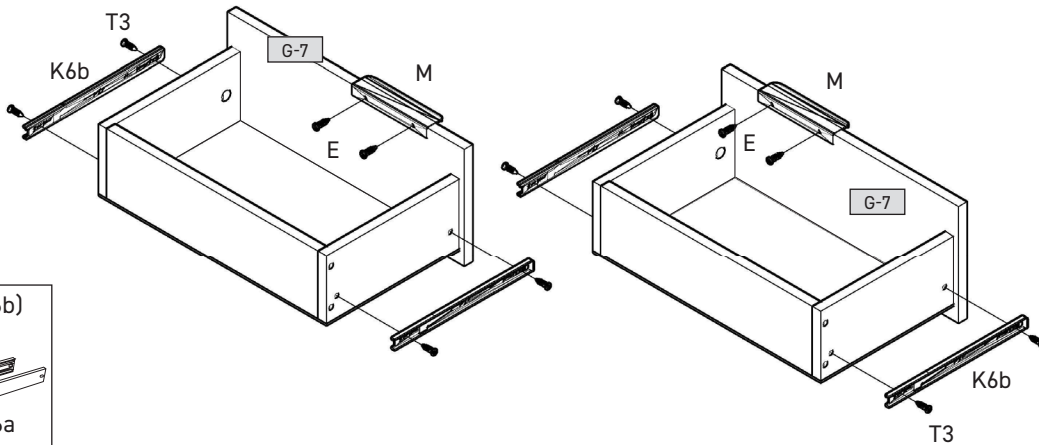

13

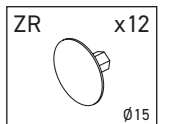
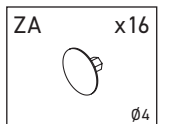
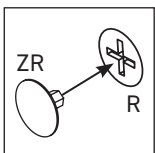
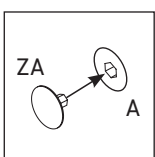
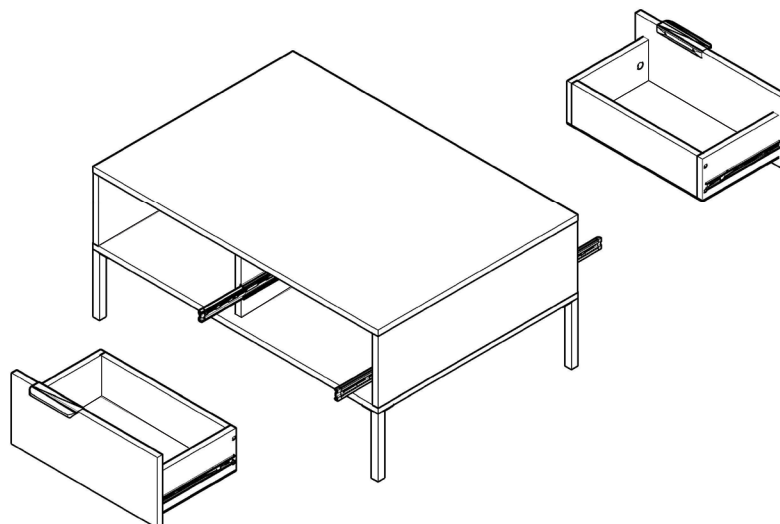

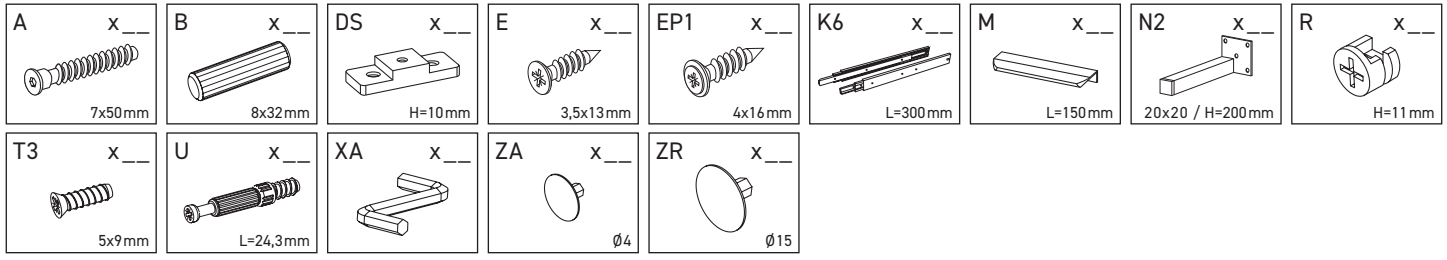

G-1	969	680	16	x 1	1/1
G-2	969	680	16	x 1	1/1
G-3	212	678	16	x 1	1/1
G-4	212	678	16	x 1	1/1
G-5	212	614	16	x 1	1/1
G-6	212	320	16	x 1	1/1
G-7	496	206	16	x 2	1/1
G-8	300	120	16	x 2	1/1
G-9	300	120	16	x 2	1/1
G-10	426	120	16	x 2	1/1
G-11	456	306	3	x 2	1/1

