

4066 x8

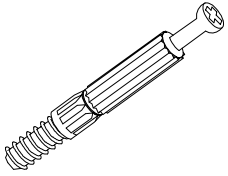

Ø6,5x36,5 mm

3996 x8

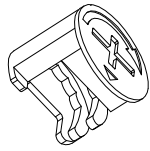

Ø15x12 mm

136236 x8

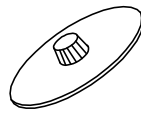

Ø15 mm

3989 x30

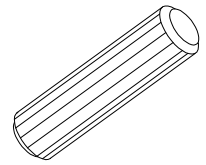

Ø8x30 mm

4057 x4

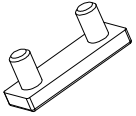

48x16x19.5 mm

4044 x8

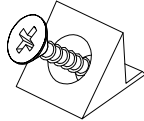

15x14x11 mm

3918 x14



Ø3,5x16 mm

IN01608 x3

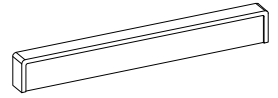

150x20x11 mm

3877 x12

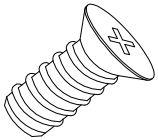

Ø6,0x13 mm

IN01157 x12

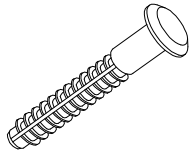

Ø12x42 mm

3983 x2

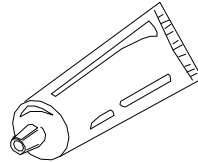

10 g

3894 x6

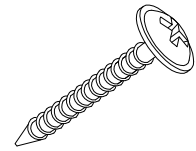

Ø4,0x30 mm

IN00378 x1

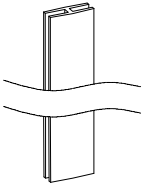

L-710 mm

3804 x3

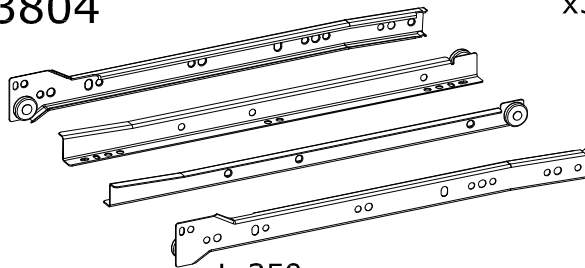



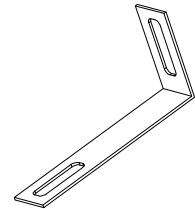

L-350mm

71900 x1





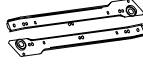

75x15x32 mm

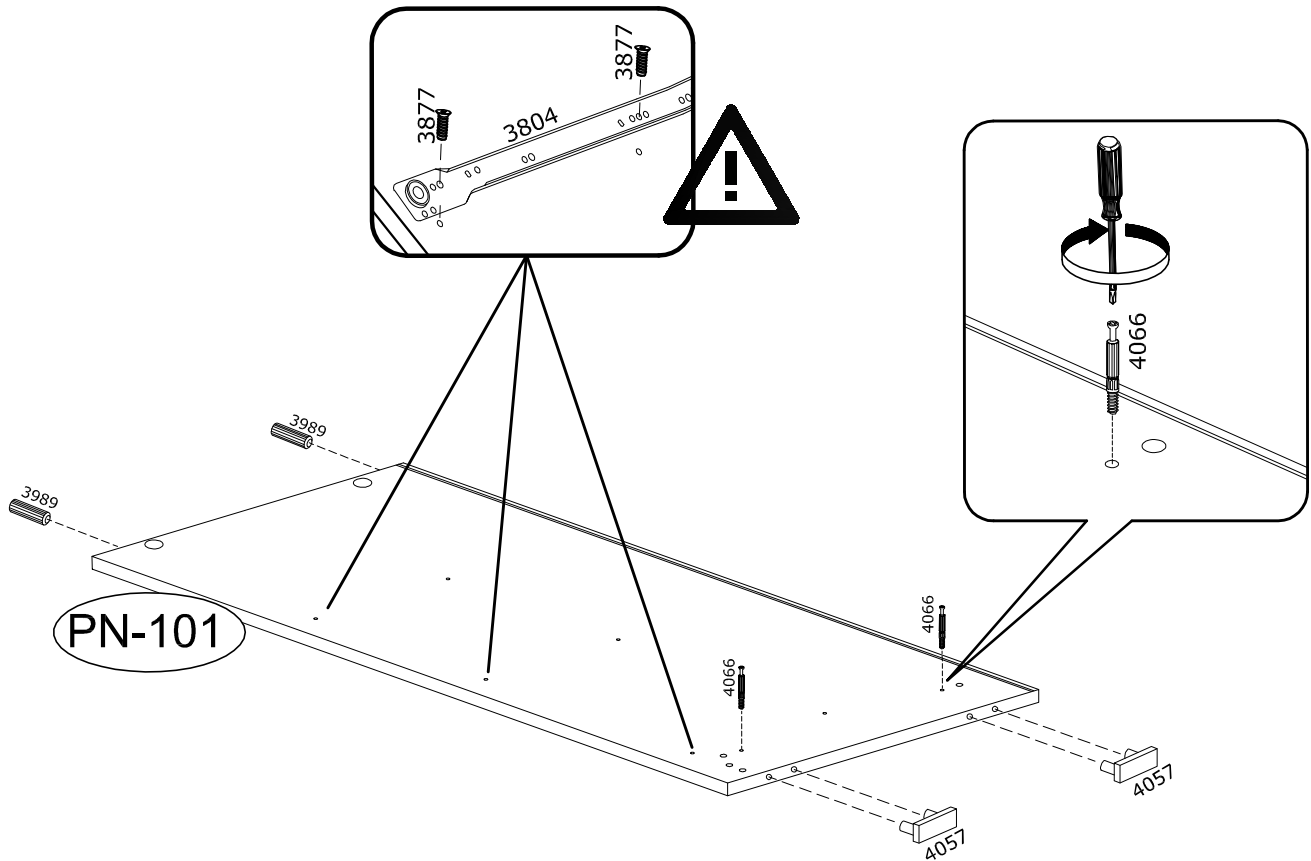
1

| | | | | | | |
|--|--|--|--|---|--|--|
| 4066  x2 | 3877  6,0X13 x6 | 4057  x2 | 3804  x3 | 3989  x2 | |  |
|--|--|--|--|---|--|--|

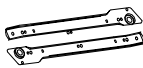

2

| | | | | | | |
|---|---|---|---|--|--|---|
| 4066  x2 | 3877  6,0X13 x6 | 4057  x2 | 3804  x3 | 3989  x2 | |  |
|---|---|---|---|--|--|---|

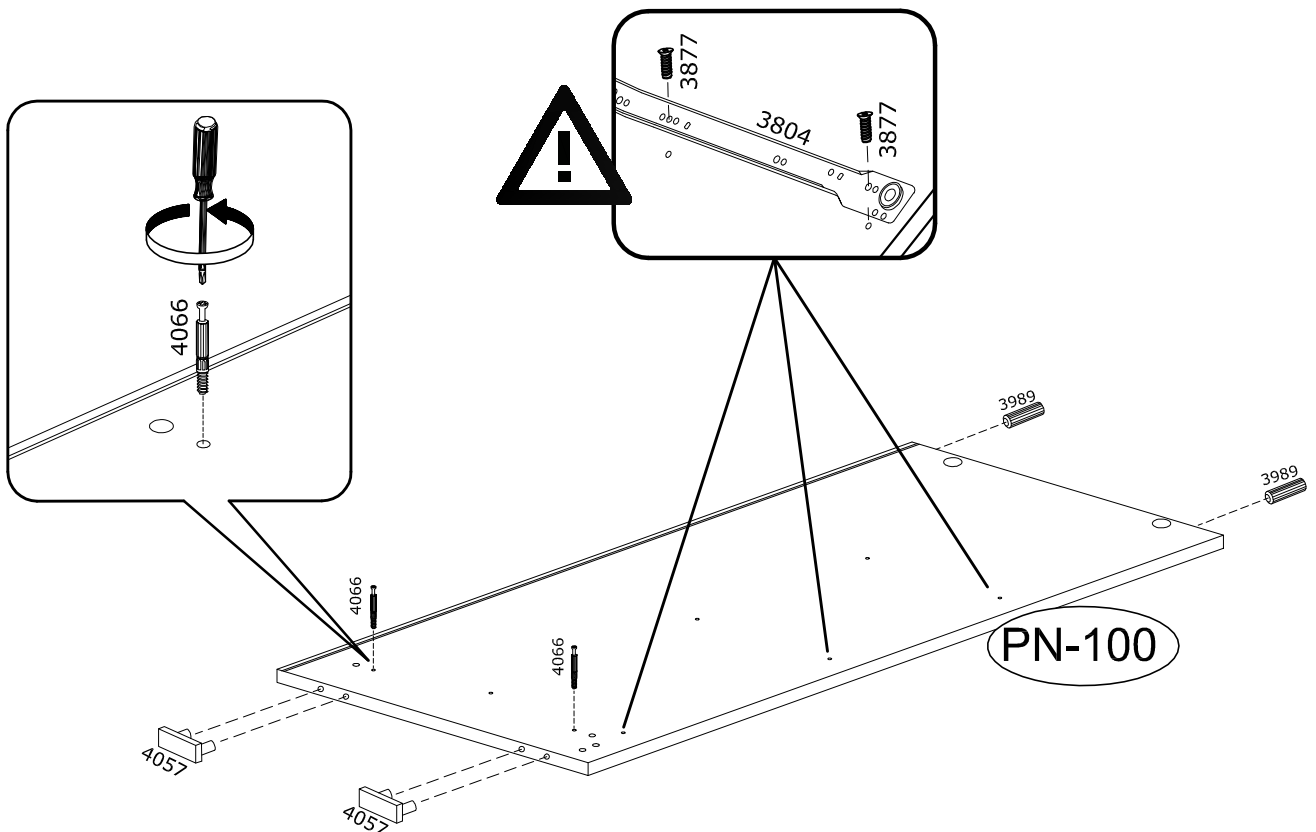

3

3989



x8

3996



x4

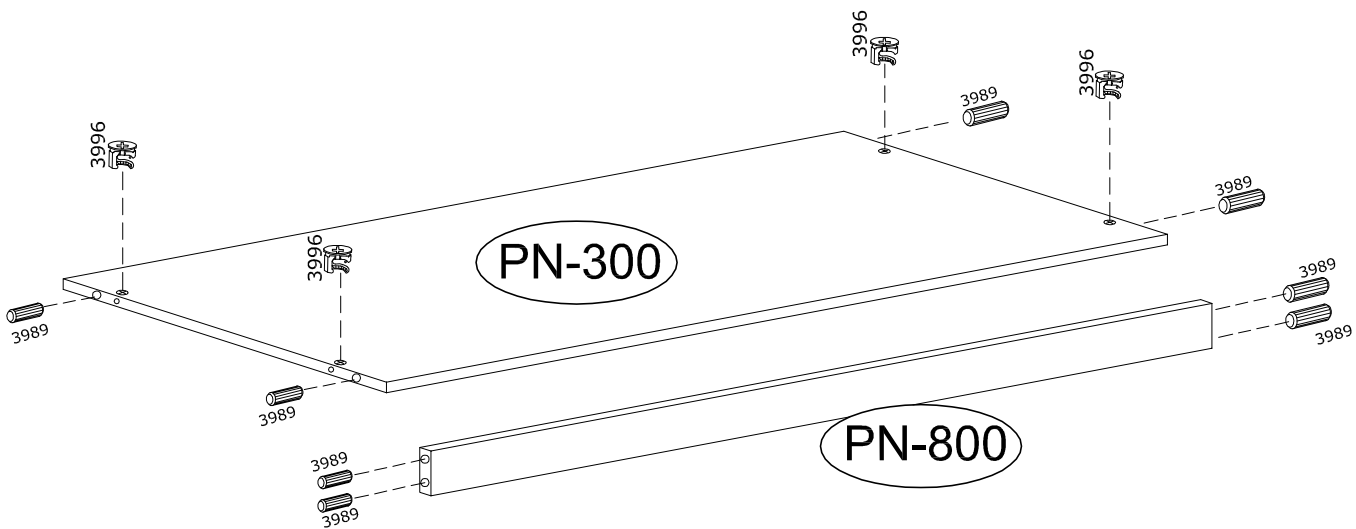

4

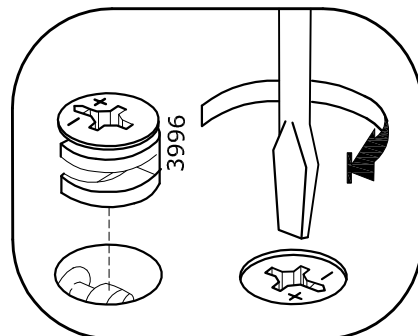
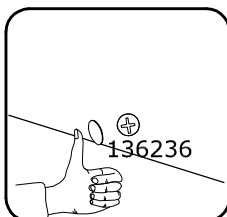
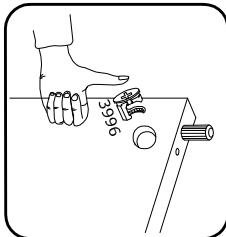
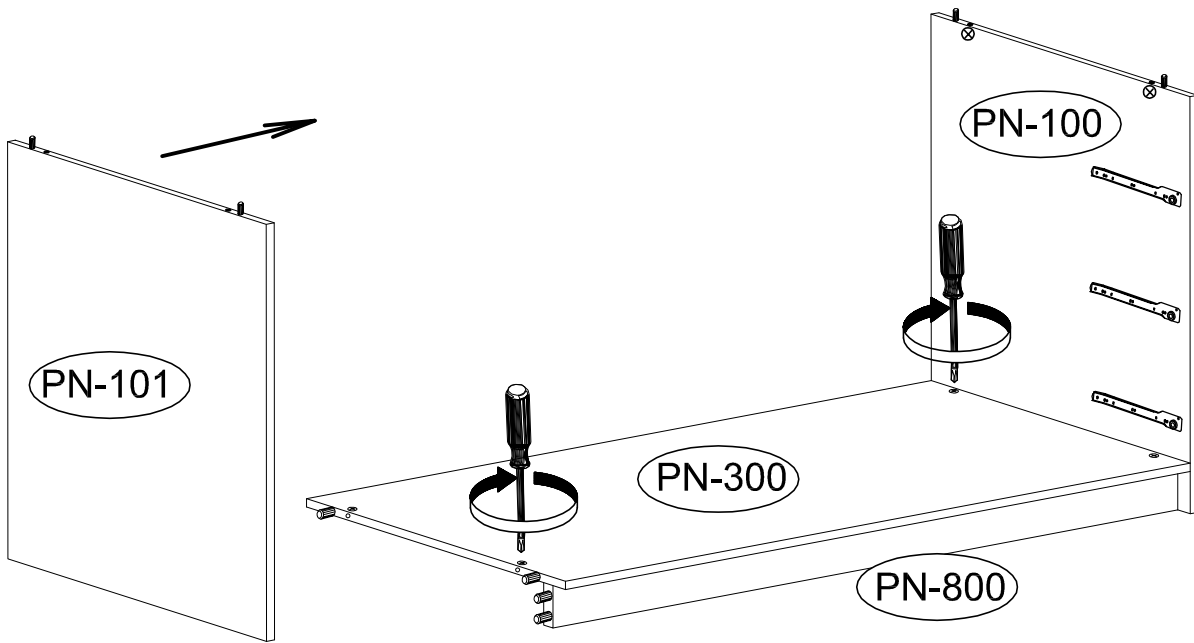

5

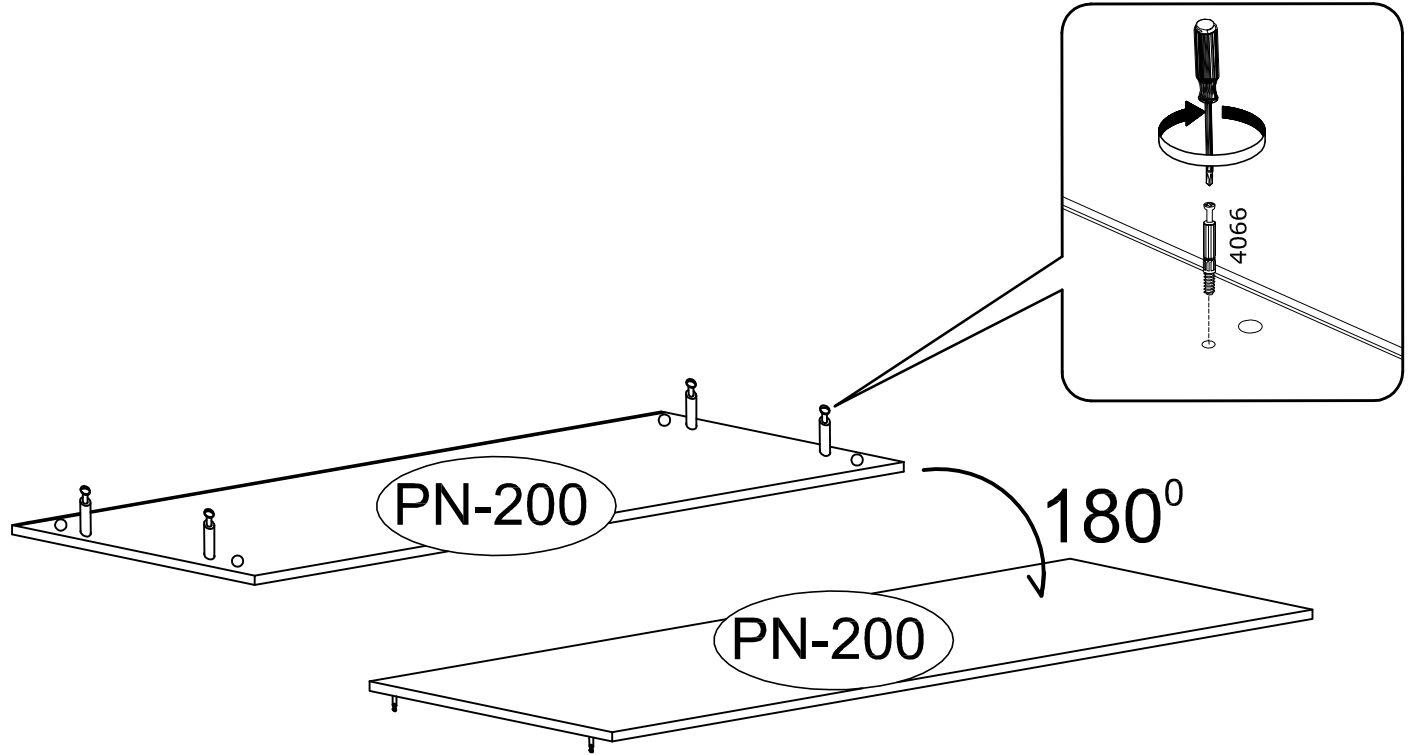
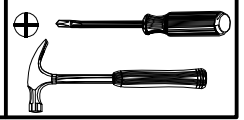
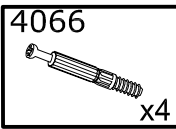

6

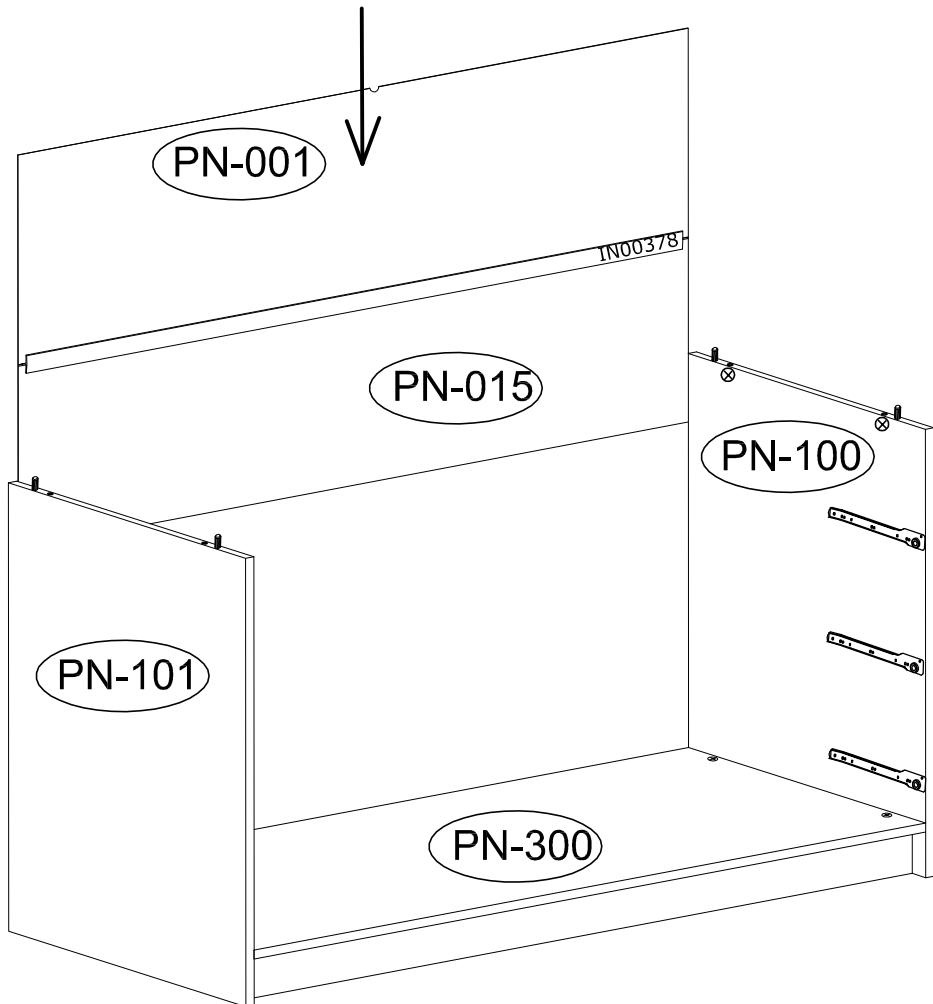
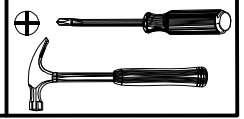
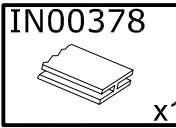

7

| | | |
|--|--|--|
| 3996  x4 | 136236  x4 |  |
|--|--|--|

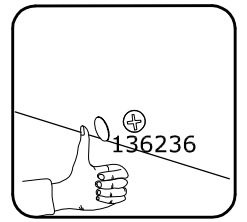
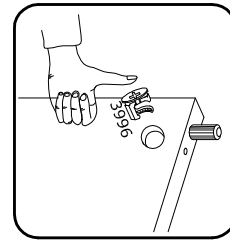
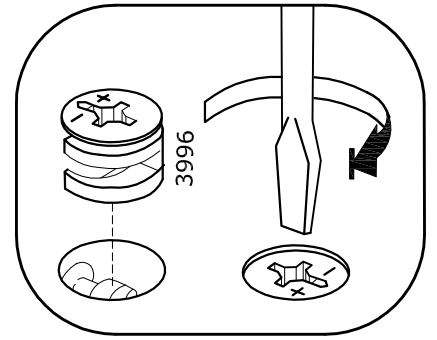
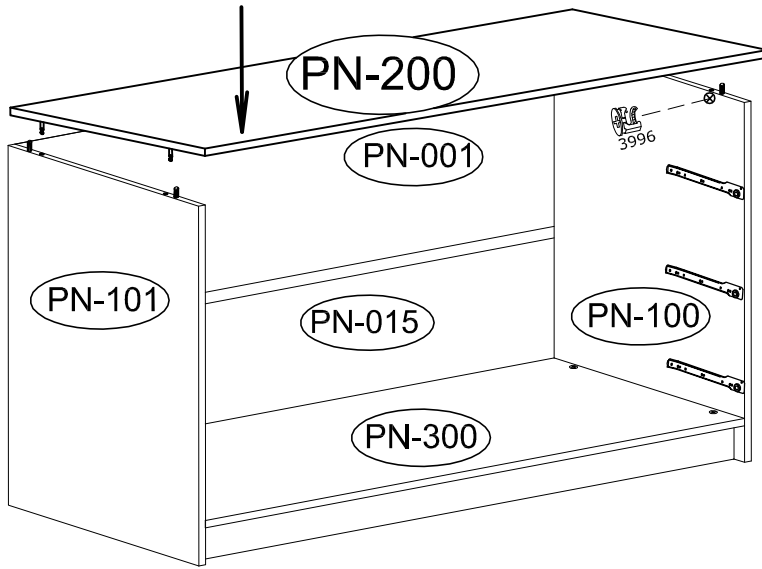

8

| | |
|---|--|
| 4044  x8 |  |
|---|--|

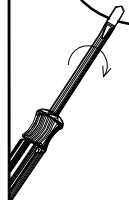
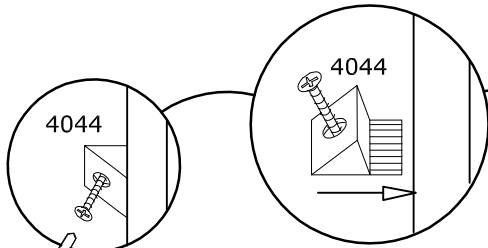
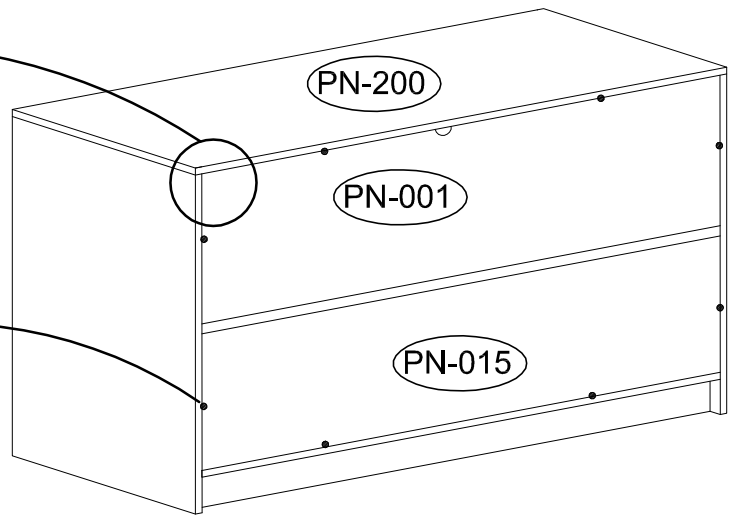
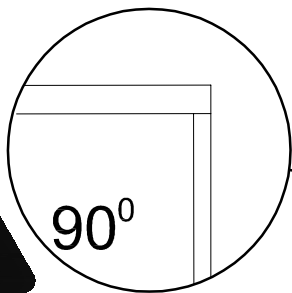
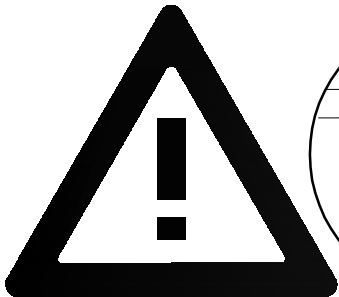

9

3918
x2

71900
x1

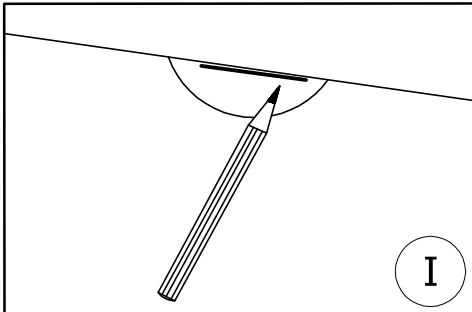
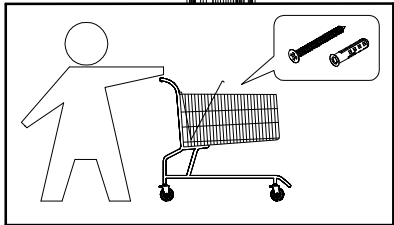
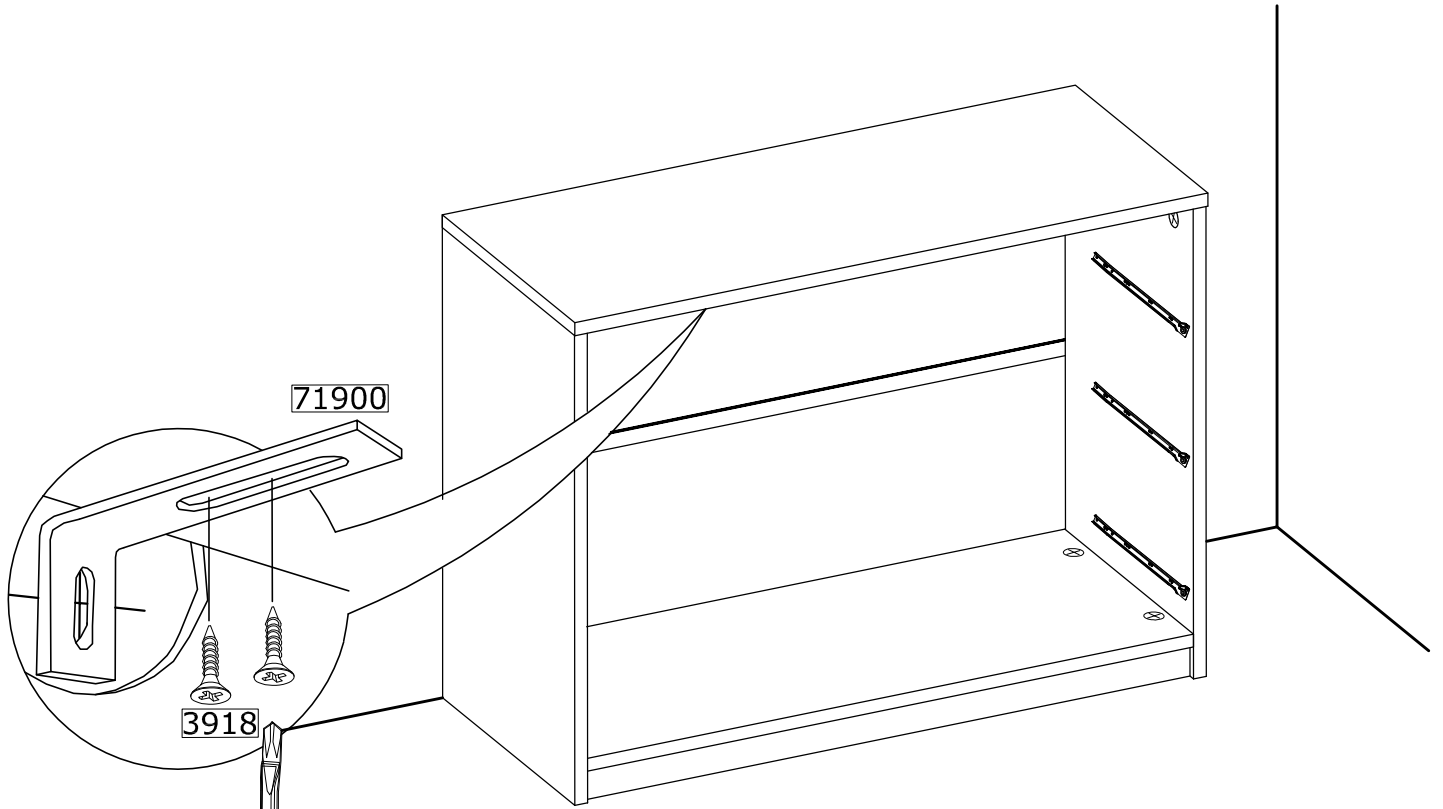
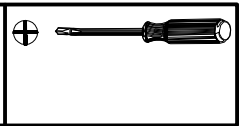

I

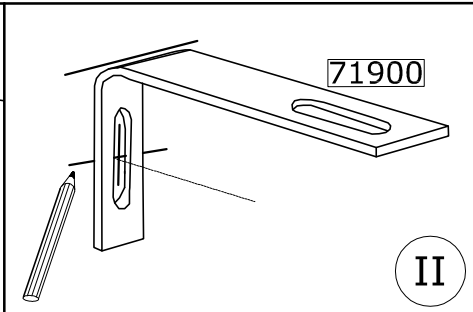

II

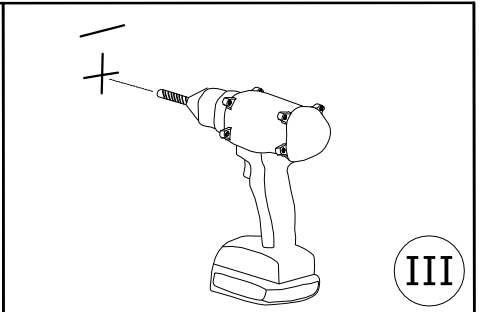

III

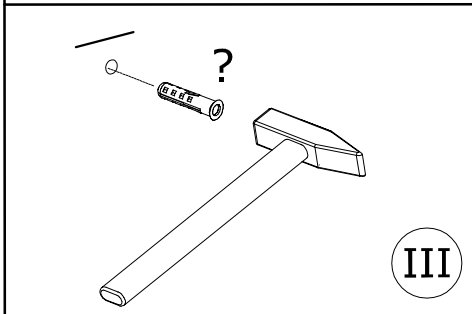

III

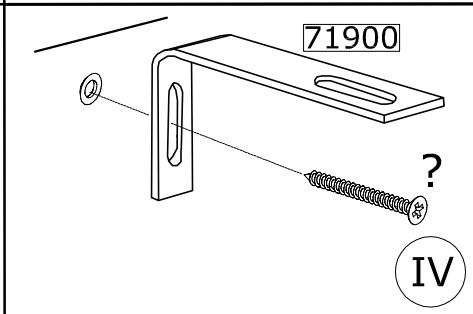

IV

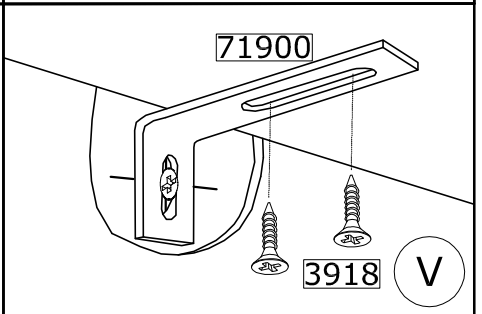

V

10

| | | | | |
|----------------|------------|-------------|--|--|
| IN01157 x12 | 3983 x1 | 3989 x18 | |  |
|----------------|------------|-------------|--|--|

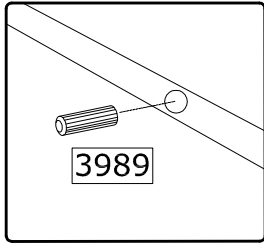

x3

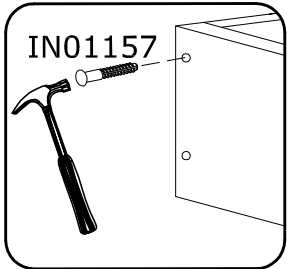
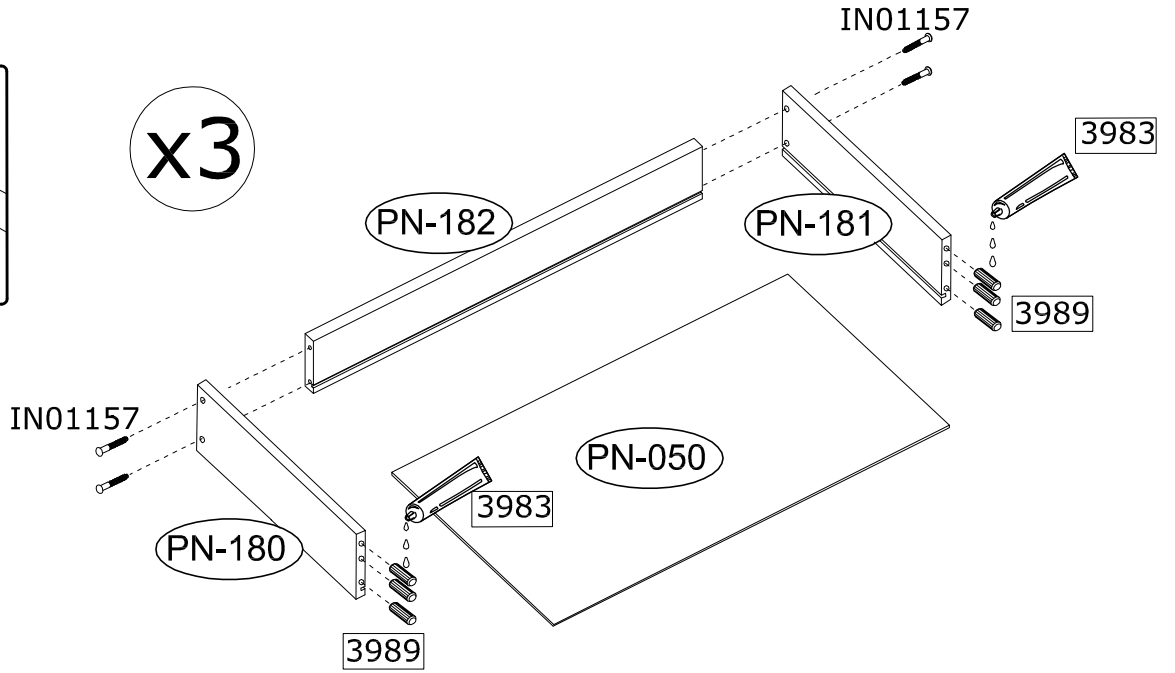

11

| | | | |
|---------------|------------|--|---|
| IN01608 x3 | 3893 x6 | |  |
|---------------|------------|--|---|

x3

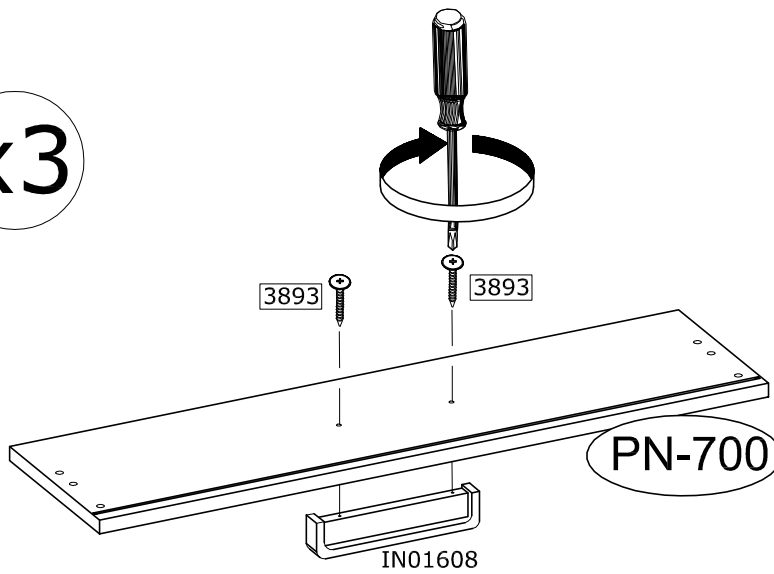

12

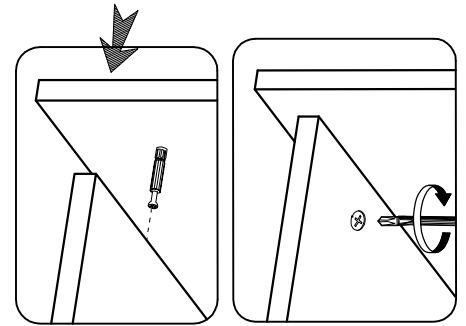
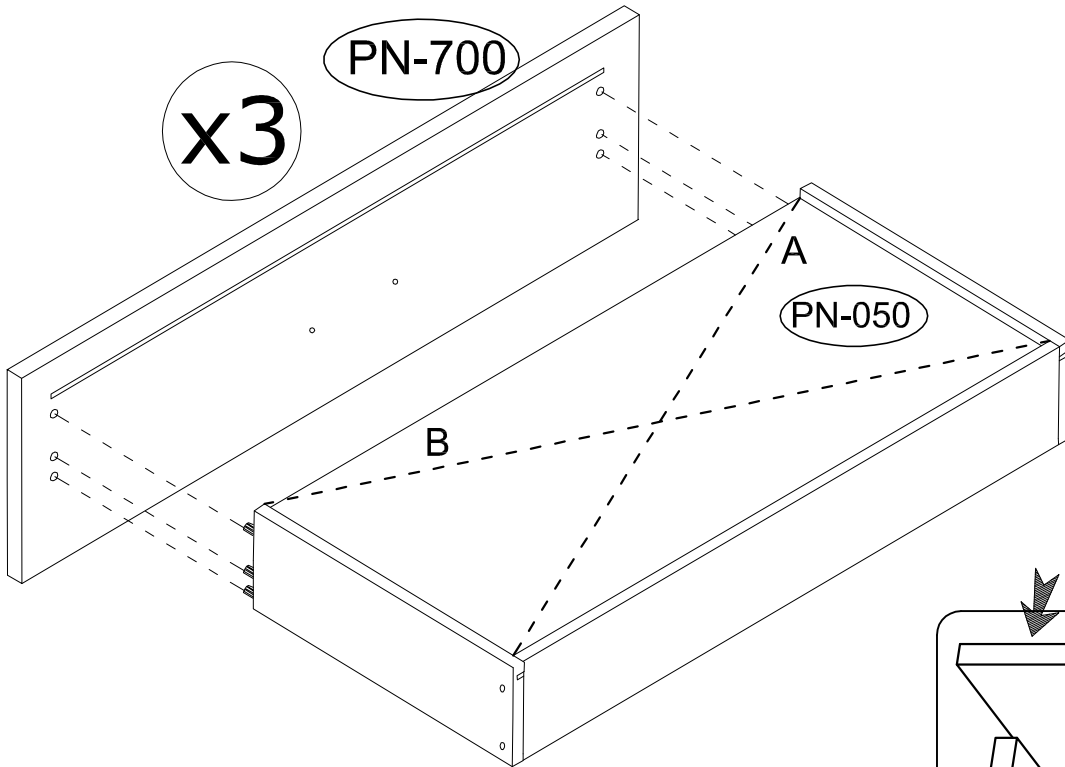
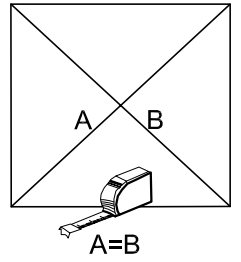
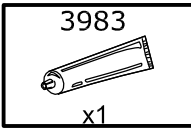

13

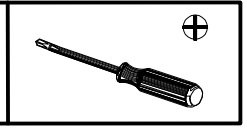
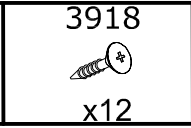
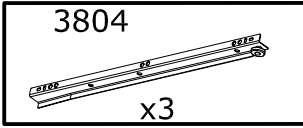

x3

