

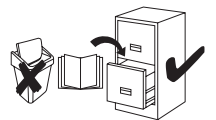

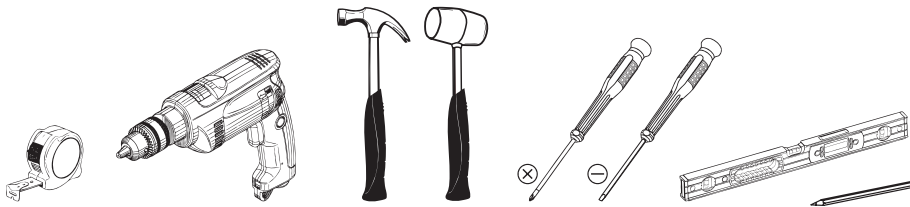

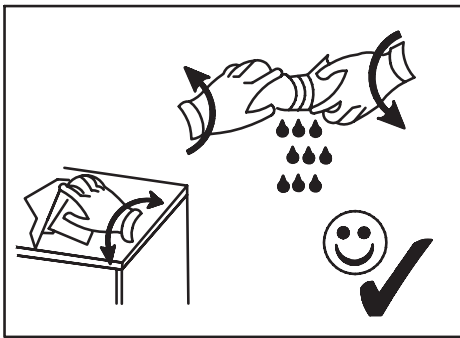

 200

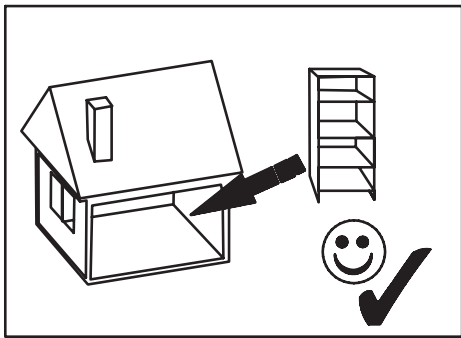
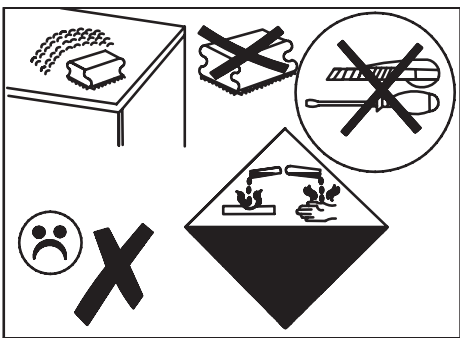
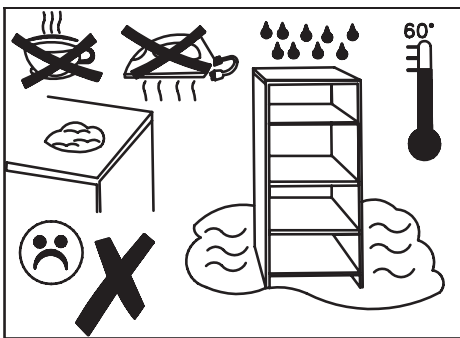
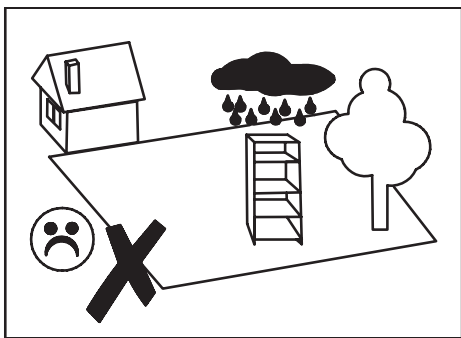
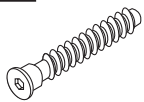
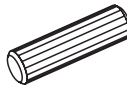
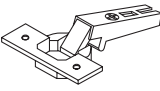
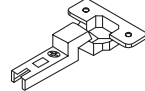
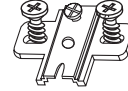
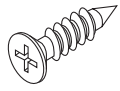
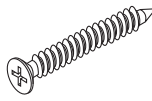

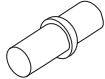
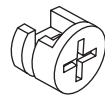
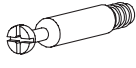
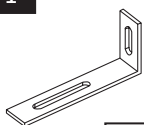
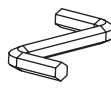

**D:**

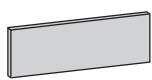
<p><b>A</b></p>  <p>7 x 50 mm x 20</p>	<p><b>B</b></p>  <p>8 x 32 mm x 38</p>	<p><b>C</b></p>  <p>(P) x 4</p>	<p><b>C3</b></p>  <p>(B) x 2</p>	<p><b>DT</b></p>  <p>x 6</p>	<p><b>E</b></p>  <p>3,5 x 13 mm x 14</p>
<p><b>E2</b></p>  <p>3 x 20 mm x 9</p>	<p><b>G2</b></p>  <p>x 6</p>	<p><b>H1</b></p>  <p>x 10</p>	<p><b>P</b></p>  <p>x 4</p>	<p><b>R</b></p>  <p>H=11 mm x 26</p>	<p><b>U</b></p>  <p>L=24,3 mm x 26</p>
<p><b>W1</b></p>  <p>x 2</p>	<p><b>XA</b></p>  <p>x 1</p>	<p><b>XG</b></p>  <p>GLUE x 1</p>	<p><b>ZA</b></p>  <p>Ø4 x 10</p>	<p><b>ZR</b></p>  <p>Ø15 x 22</p>	<p><b>HDF</b></p>  <p>240x100 mm x 4</p>

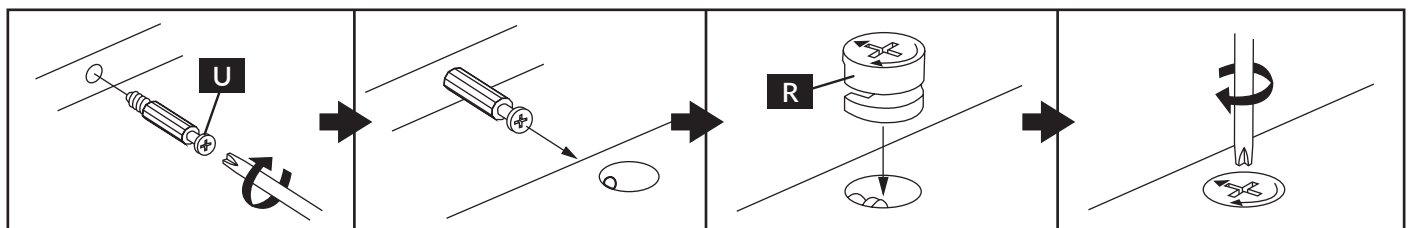
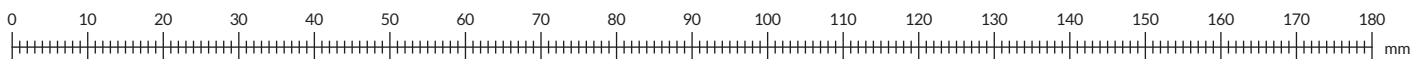
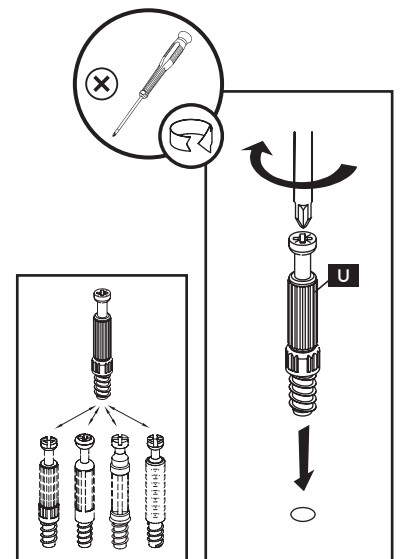
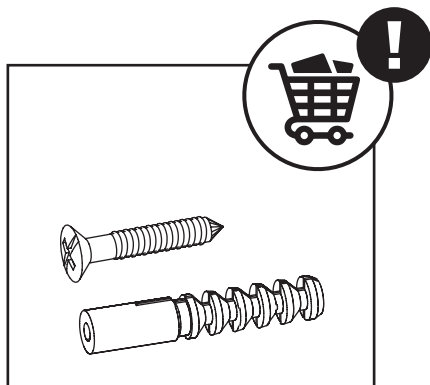

1	D-1	1318 / 80 / 16 mm	x 2
2	D-2	270 / 80 / 16 mm	x 1
3	D-3	1350 / 420 / 16 mm	x 1
4	D-4	876 / 405 / 16 mm	x 2
5	D-5	426 / 400 / 16 mm	x 1
6	D-6	1350 / 420 / 16 mm	x 1
7	D-7	700 / 420 / 16 mm	x 1
8	D-8	700 / 405 / 16 mm	x 1
9	D-9	700 / 420 / 16 mm	x 1
10	D-10	446 / 740 / 16 mm	x 1

11	D-11	446 / 250 / 16 mm	x 2
12	D-12	446 / 250 / 16 mm	x 2
13	D-13	444 / 290 / 4 mm	x 2
14	D-14	1350 / 300 / 16 mm	x 1
15	D-15	912 / 300 / 16 mm	x 1
16	D-16	100 / 300 / 16 mm	x 2
17	D-17	184 / 300 / 16 mm	x 1
18	D-18	184 / 300 / 16 mm	x 1
19	D-19	1334 / 714 / 25 mm	x 1

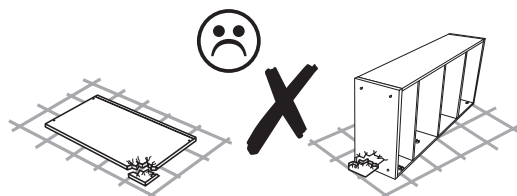
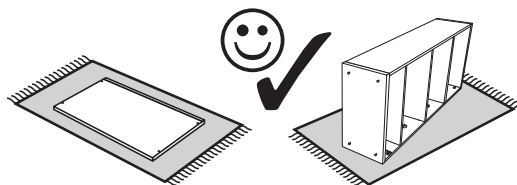
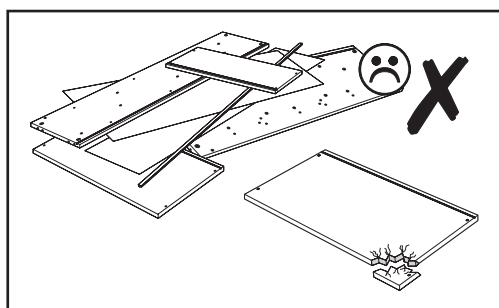
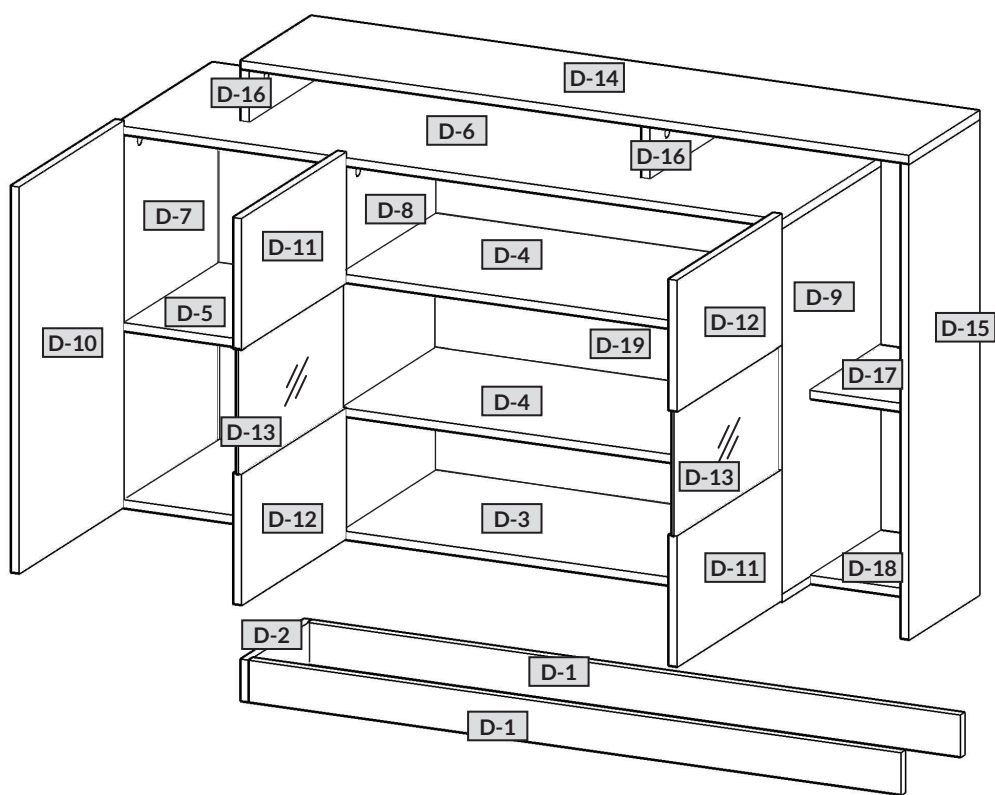

# D/1

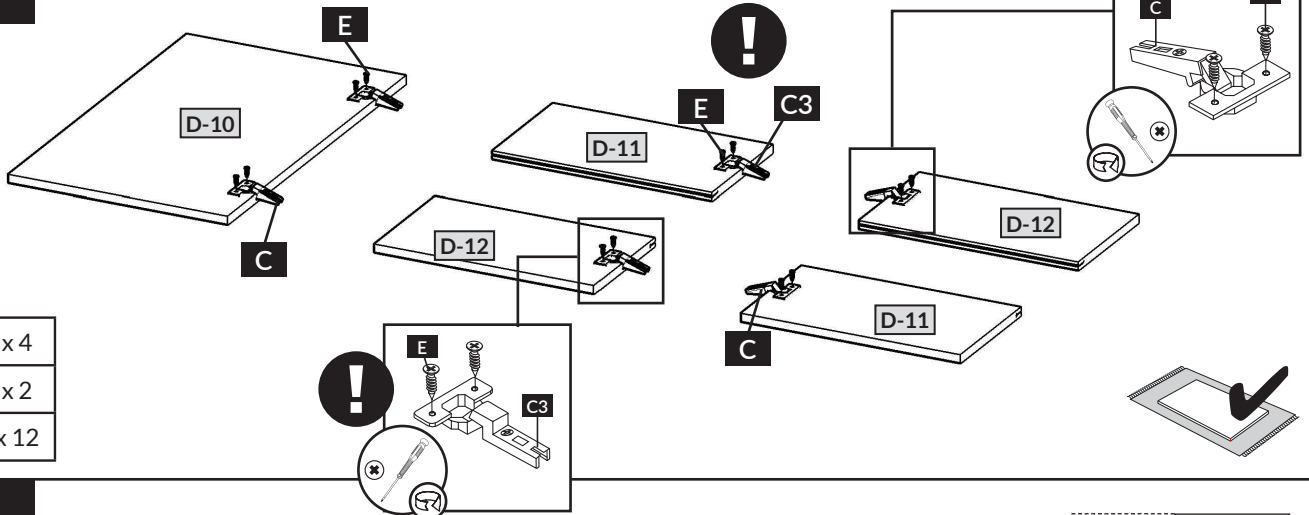

# D/2

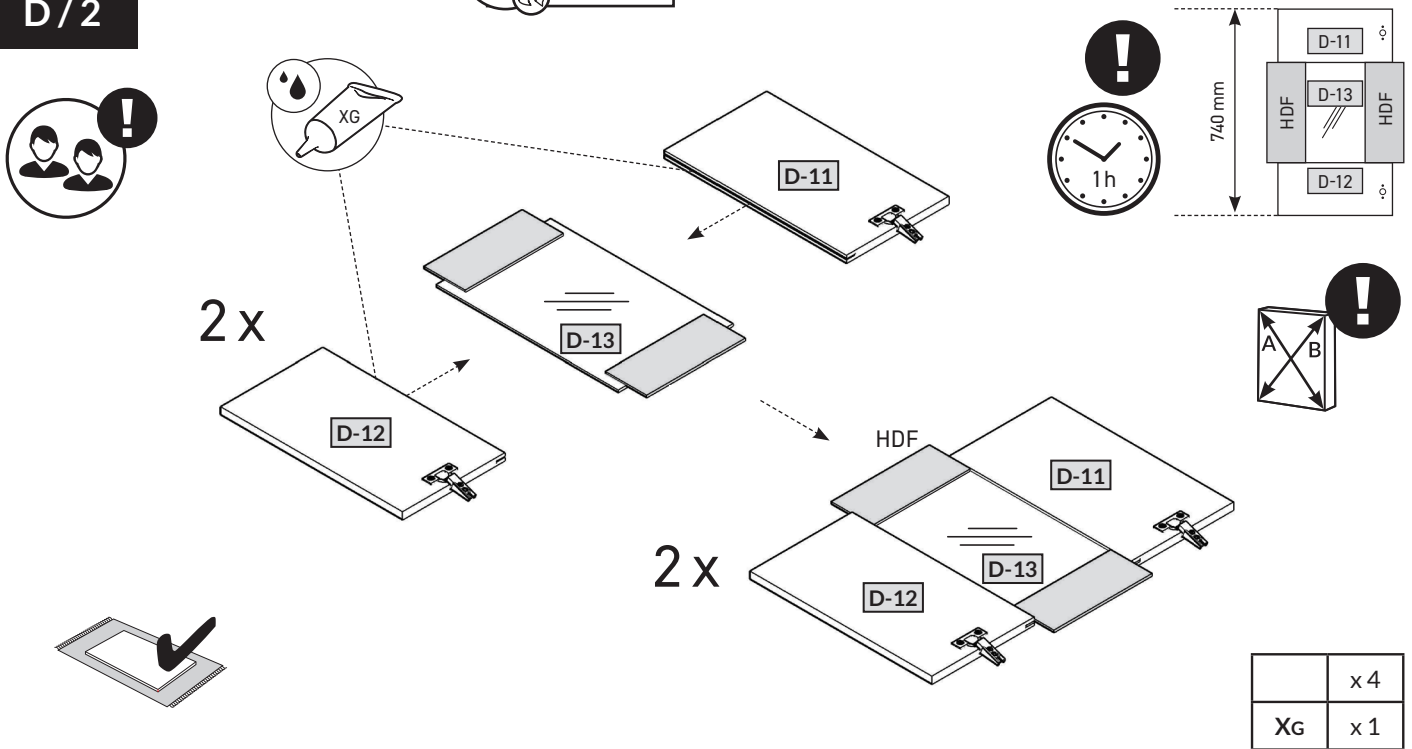

# D/3

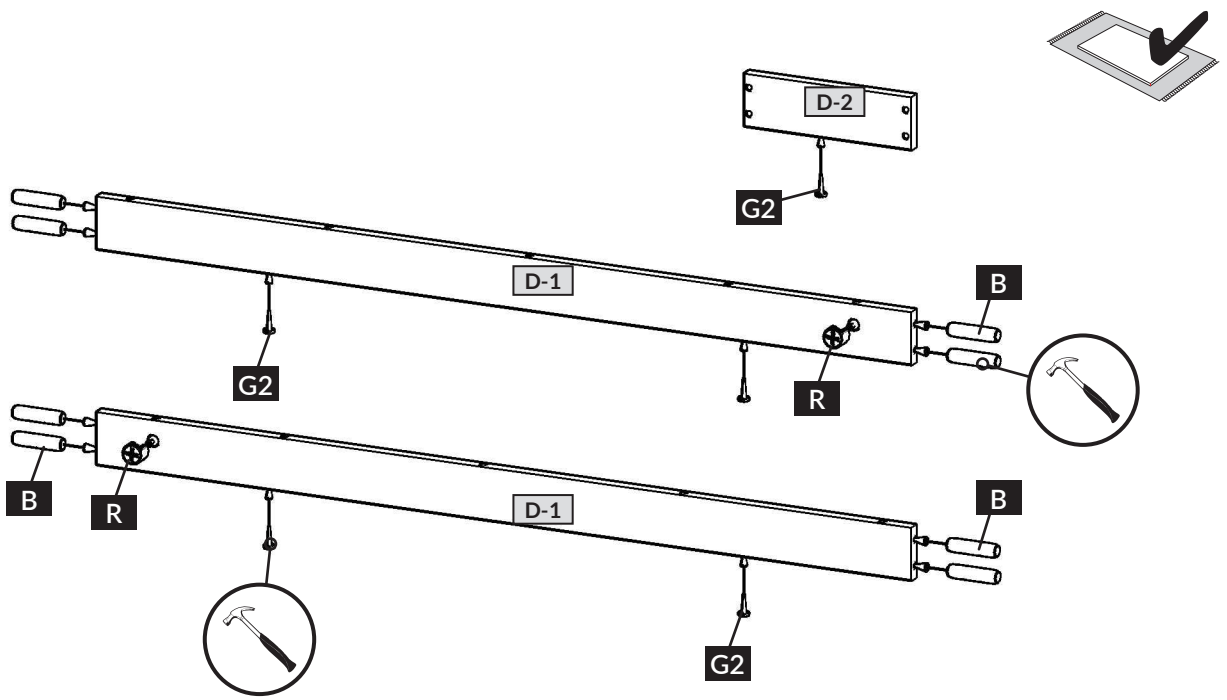

D/4

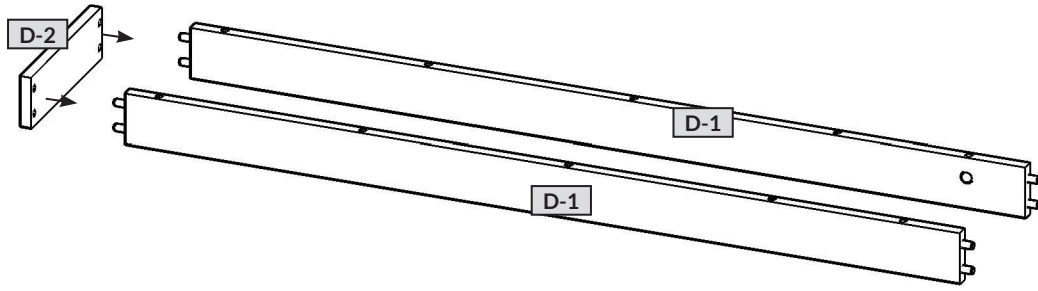

D/5

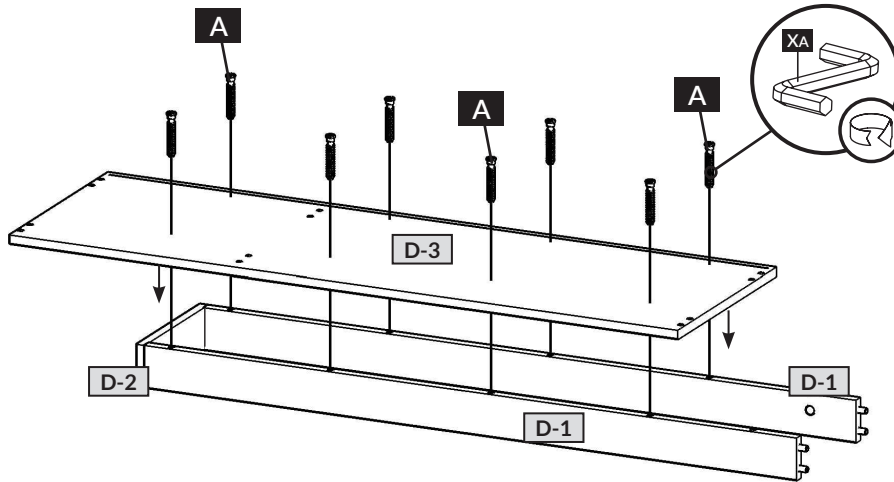

A	x8
XA	x1

D/6

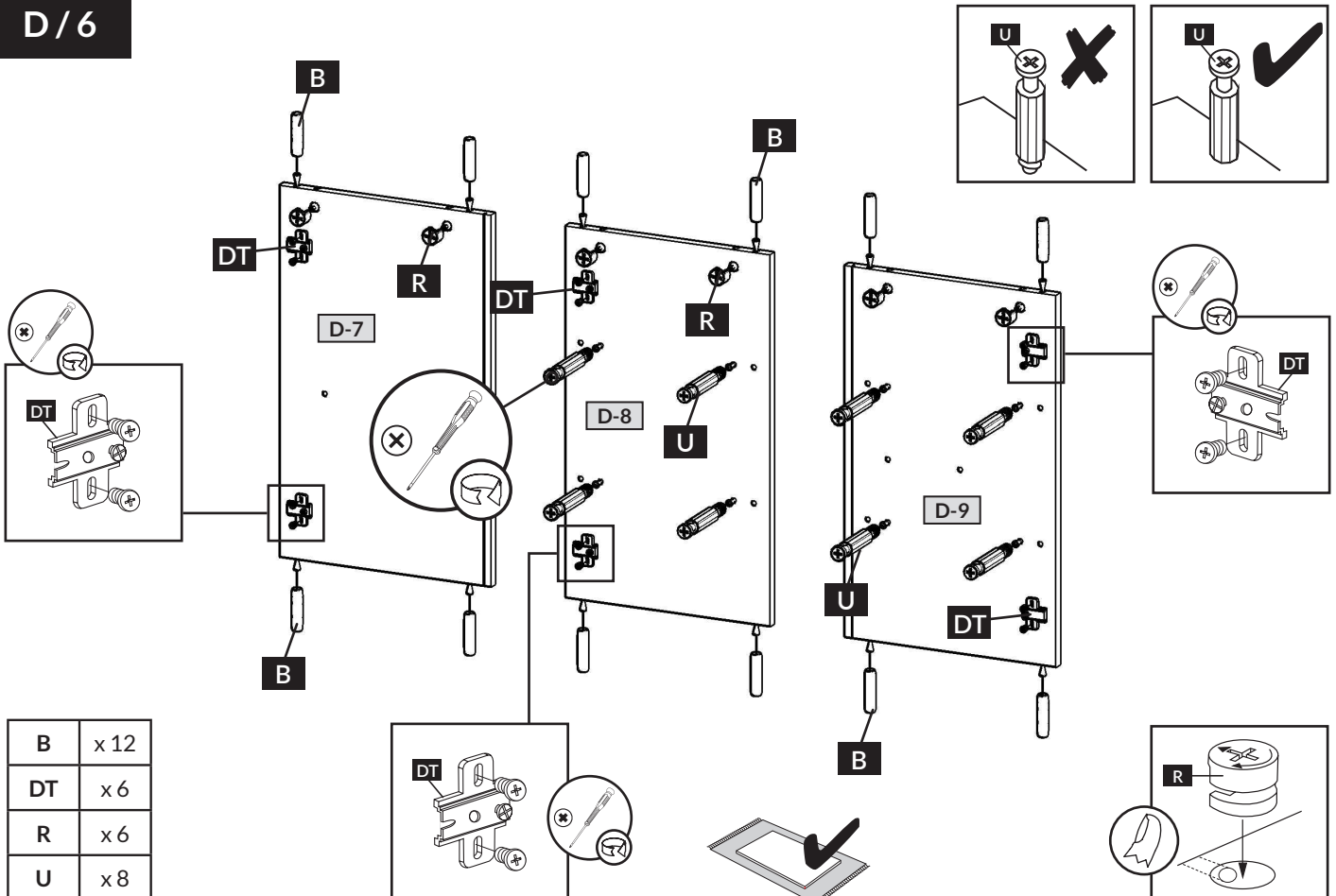

B	x12
DT	x6
R	x6
U	x8

D/7

B	x8
R	x8
U	x6

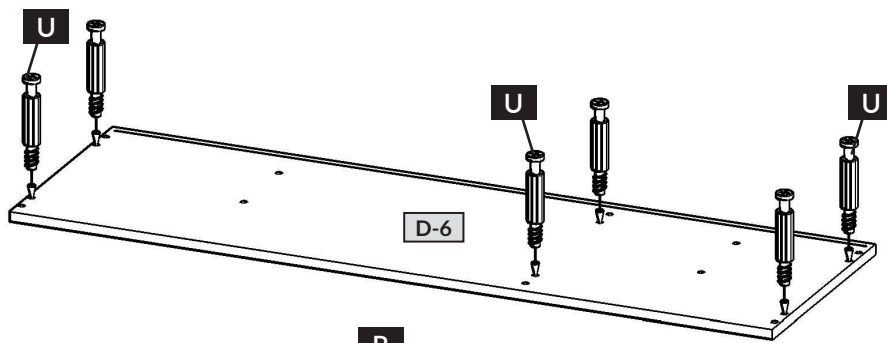
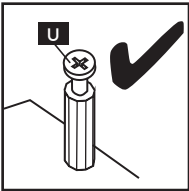
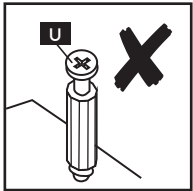
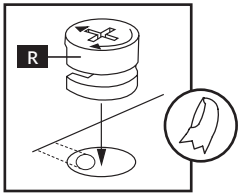
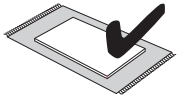

2x

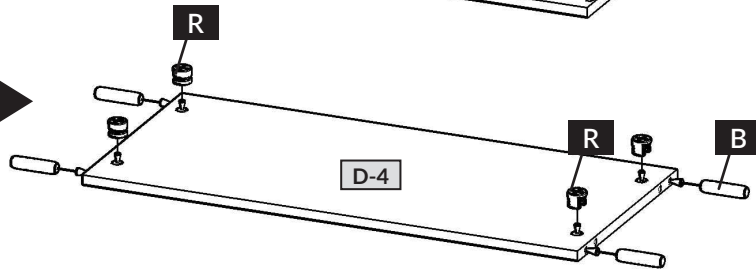

D/8

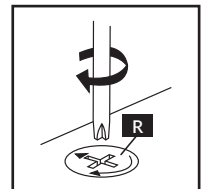
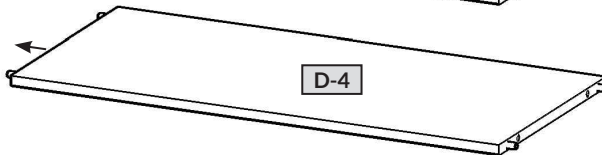
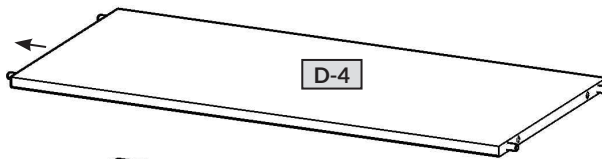
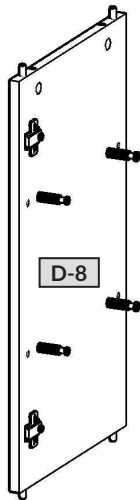
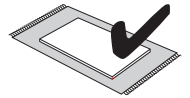

D/9

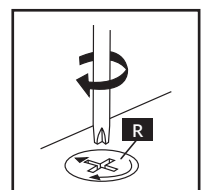
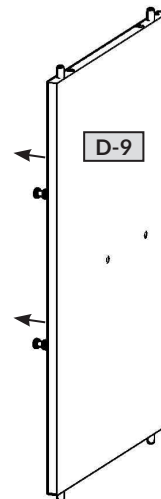
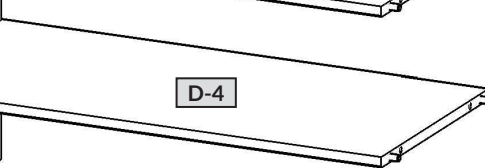
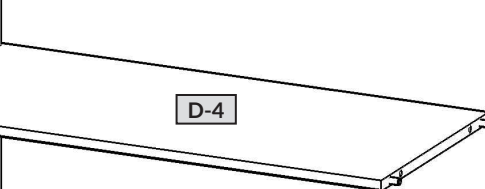
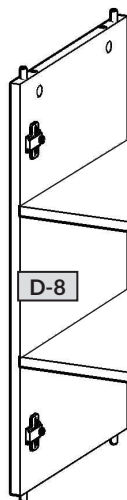
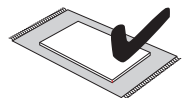

D / 10

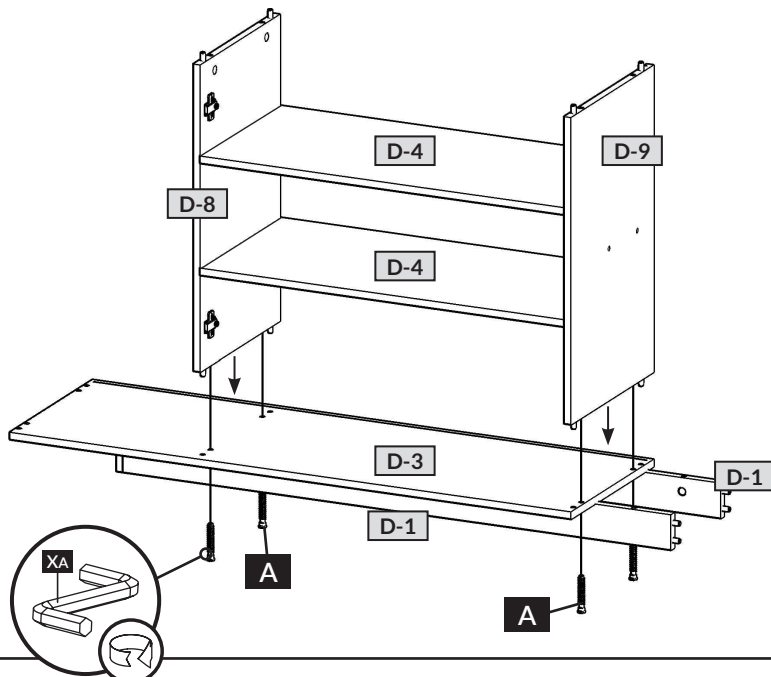
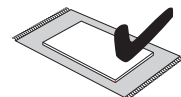

A	x4
XA	x1

D / 11

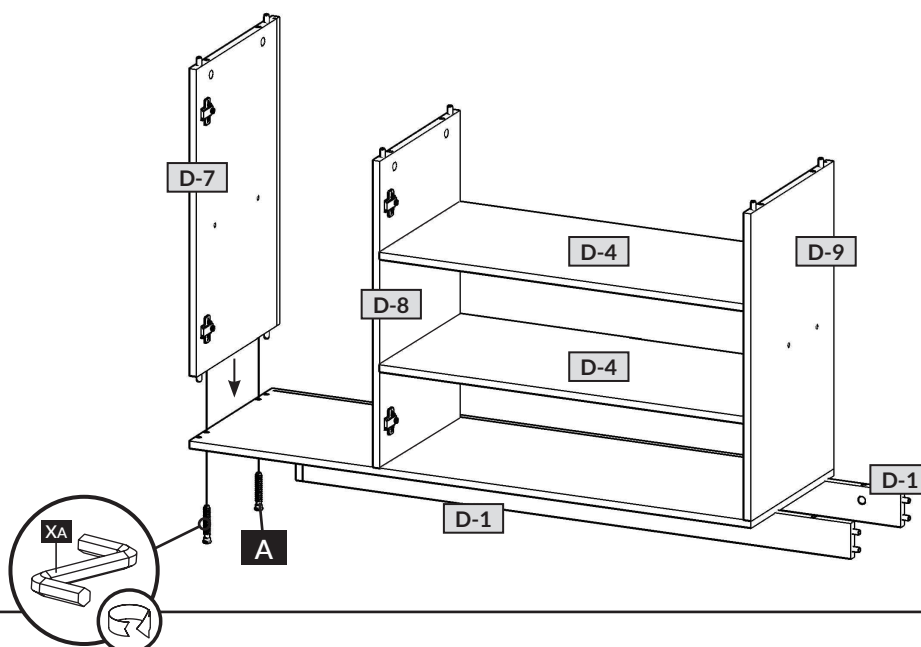
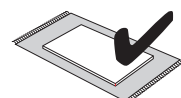

A	x2
XA	x1

D / 12

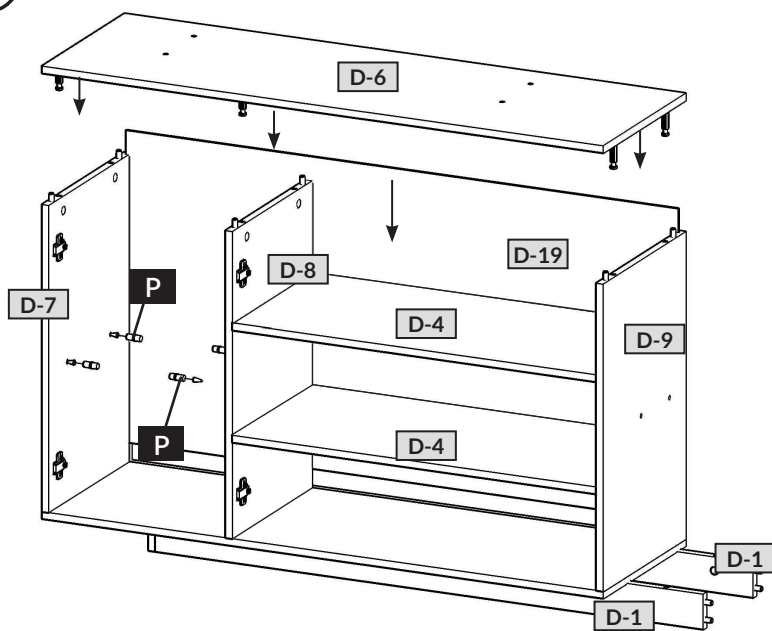
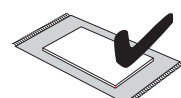

P	x4
---	----

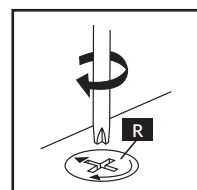
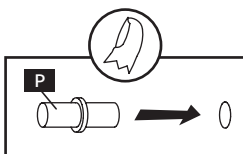



### D / 13

E2	x 9
H1	x 10

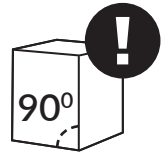
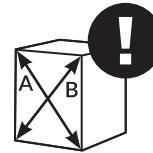
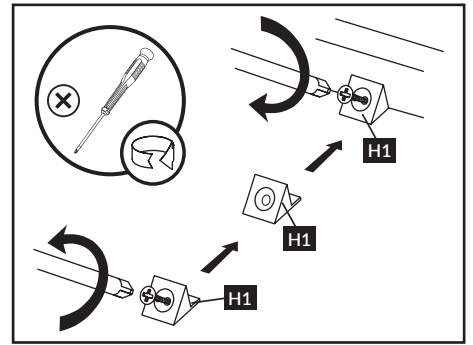
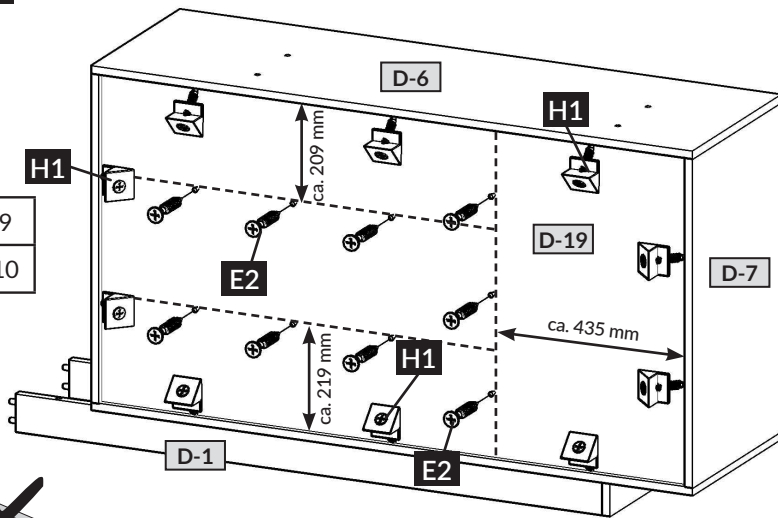

### D / 14

B	x 10
G2	x 1
R	x 12
U	x 10

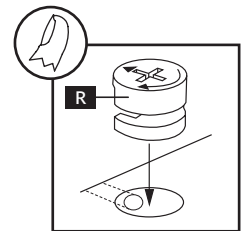
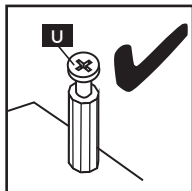
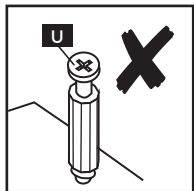
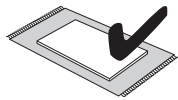
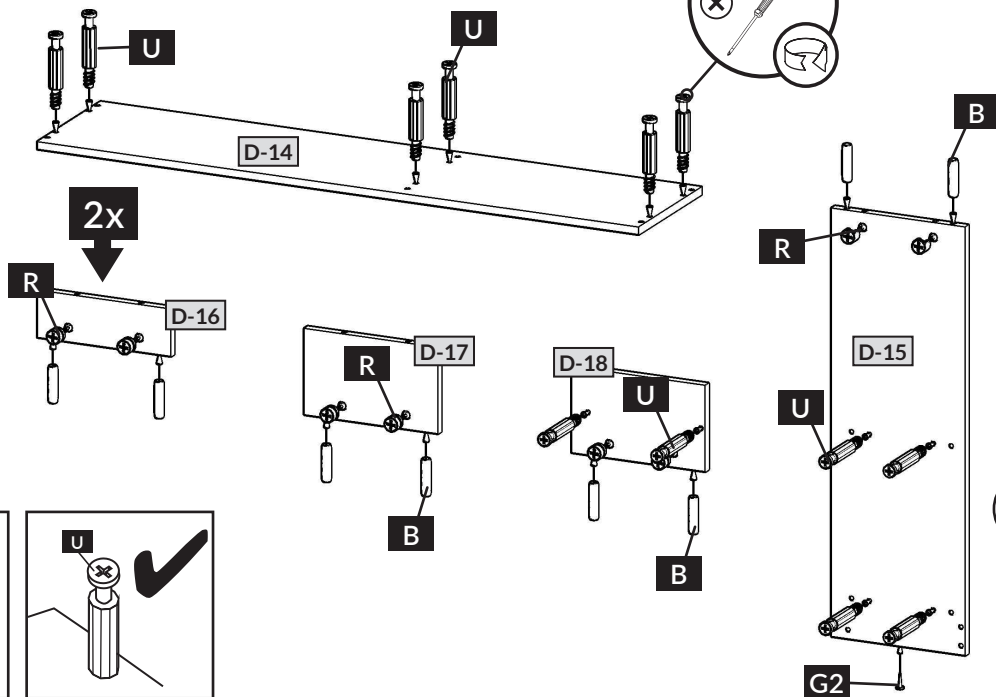

### D / 15

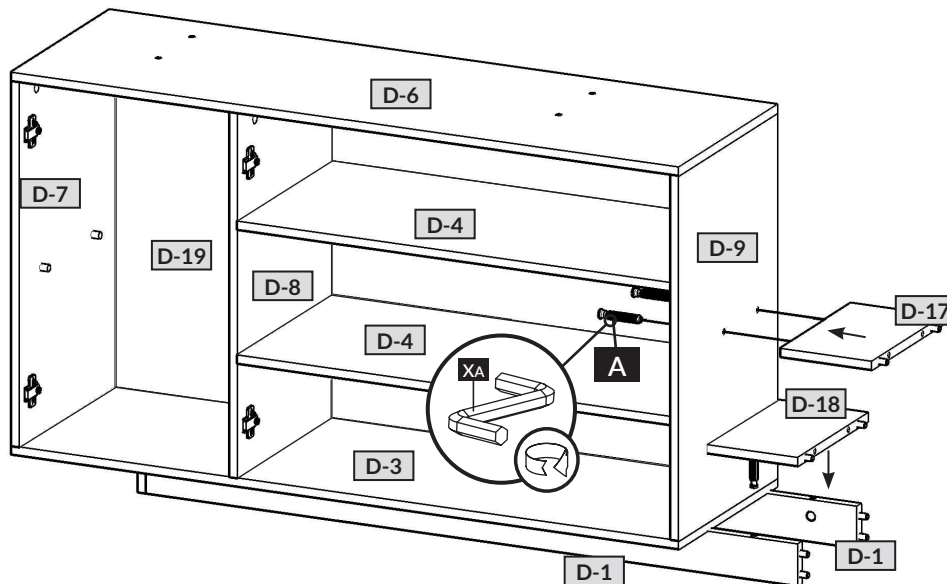
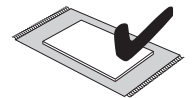

A	x 2
XA	x 1

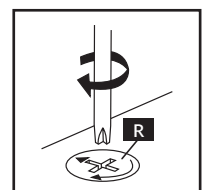

D / 16

A	x4
XA	x1

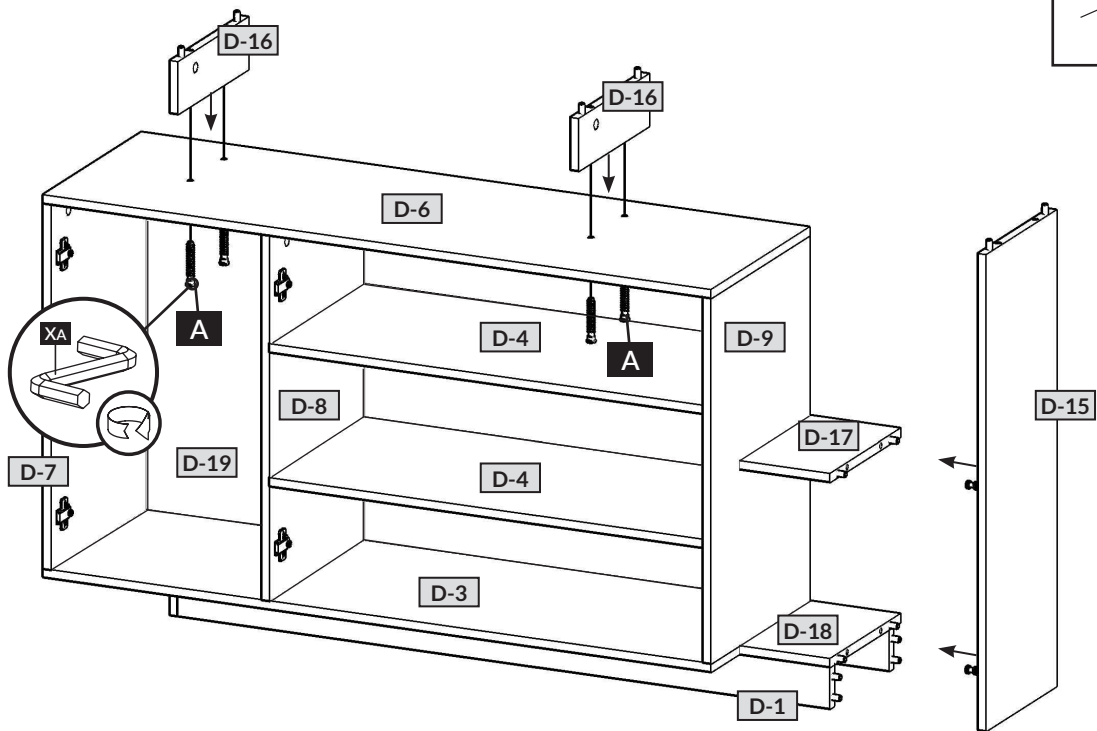
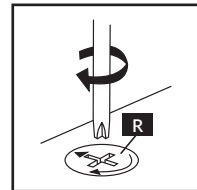

D / 17

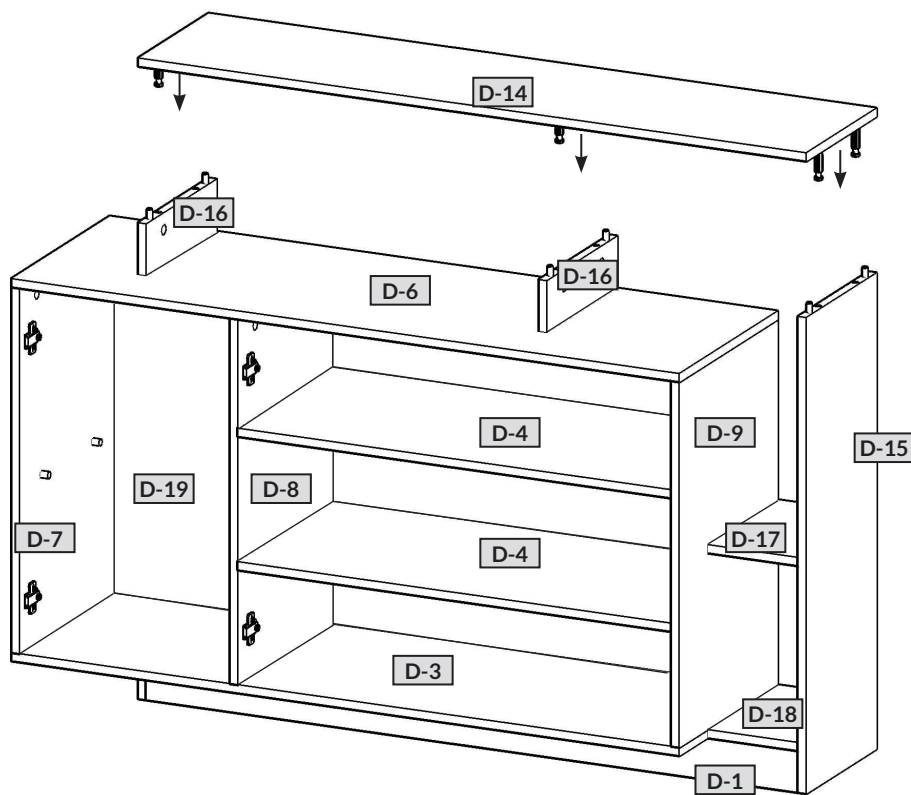
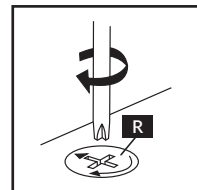

# D / 18

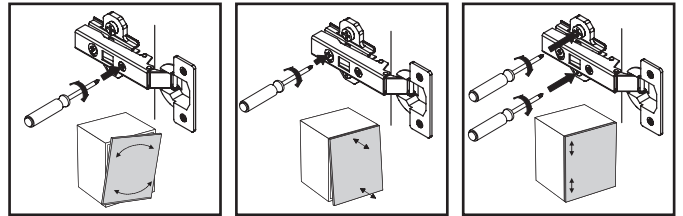
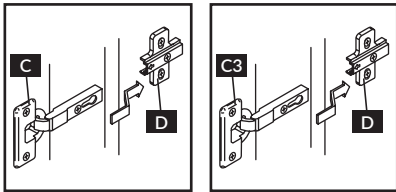
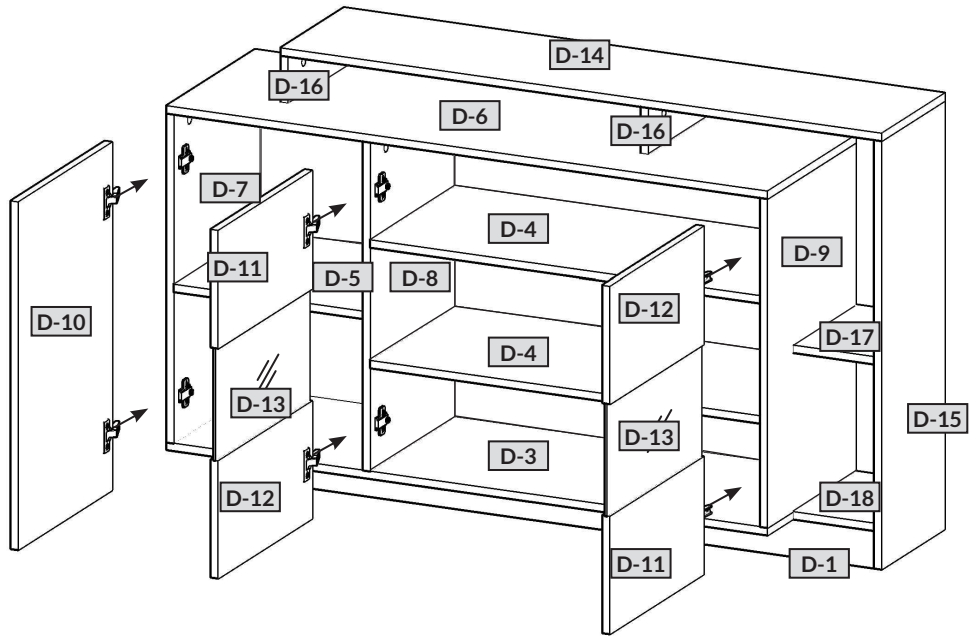
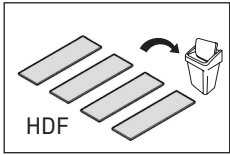

# D / 19

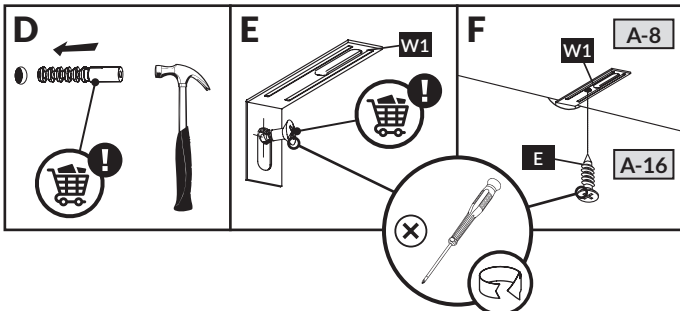
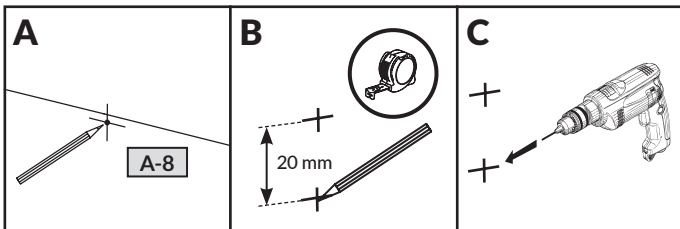
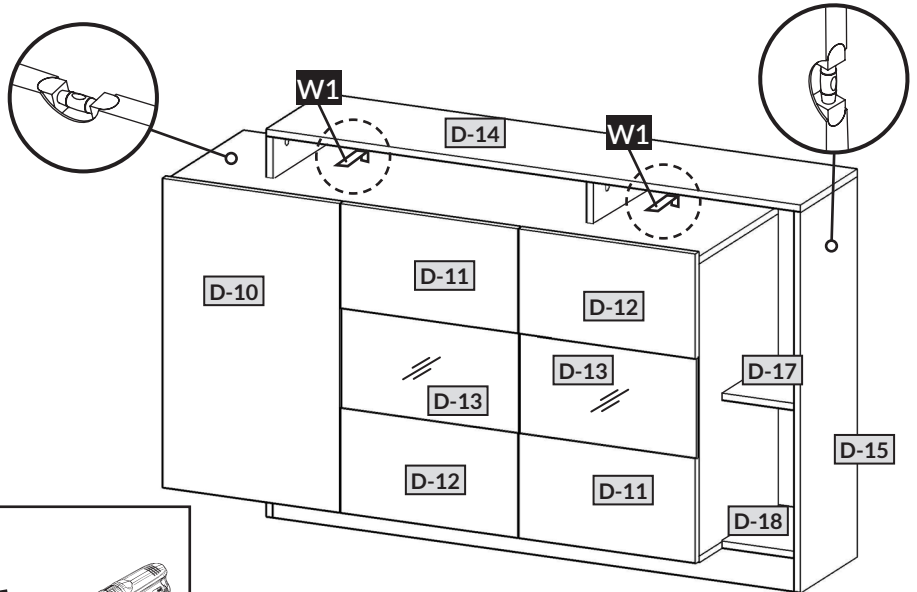
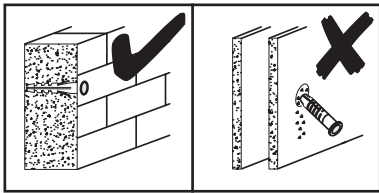

E	x 2
W1	x 2
ZA	x 10
ZR	x 22

