

a1 8x35 x...(x14)	c2 Euro 5x13 x...(x4)	e0 x...(x3)	e1 x...(x3)	f1 x...(x3)	g0 x...(x5)	g1 7x50 x...(x5)	h4 x...(x2)	i2 4x16 x...(x1)
i1 4x35 x...(x2)	i12 4x30 x...(x4)	m x...(x1)	o2 x...(x4)	p1 x...(x2)	p3 x...(x1)	q x...(x1)		

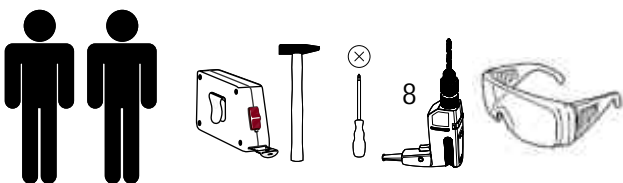

1

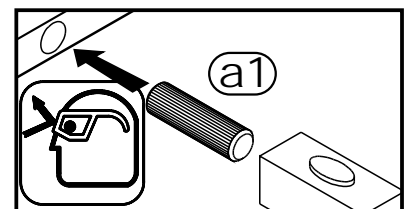
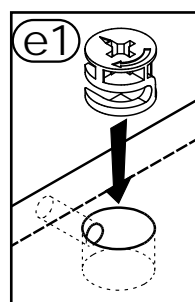
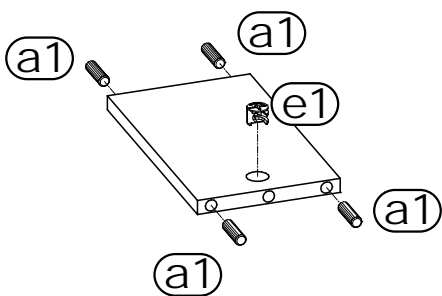
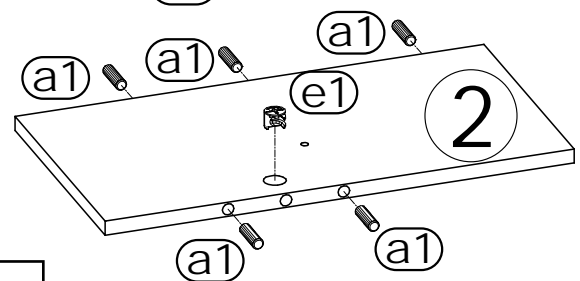
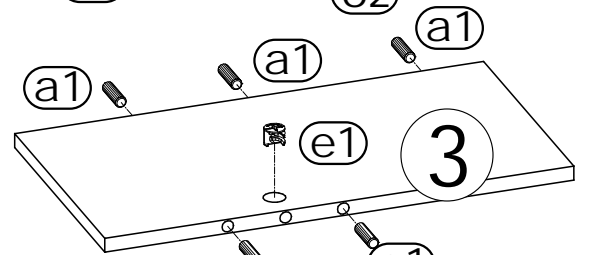
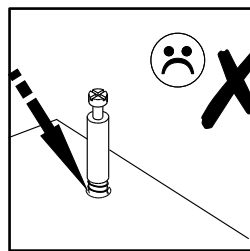
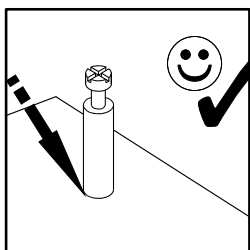
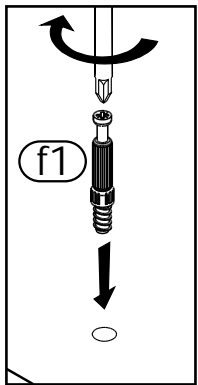
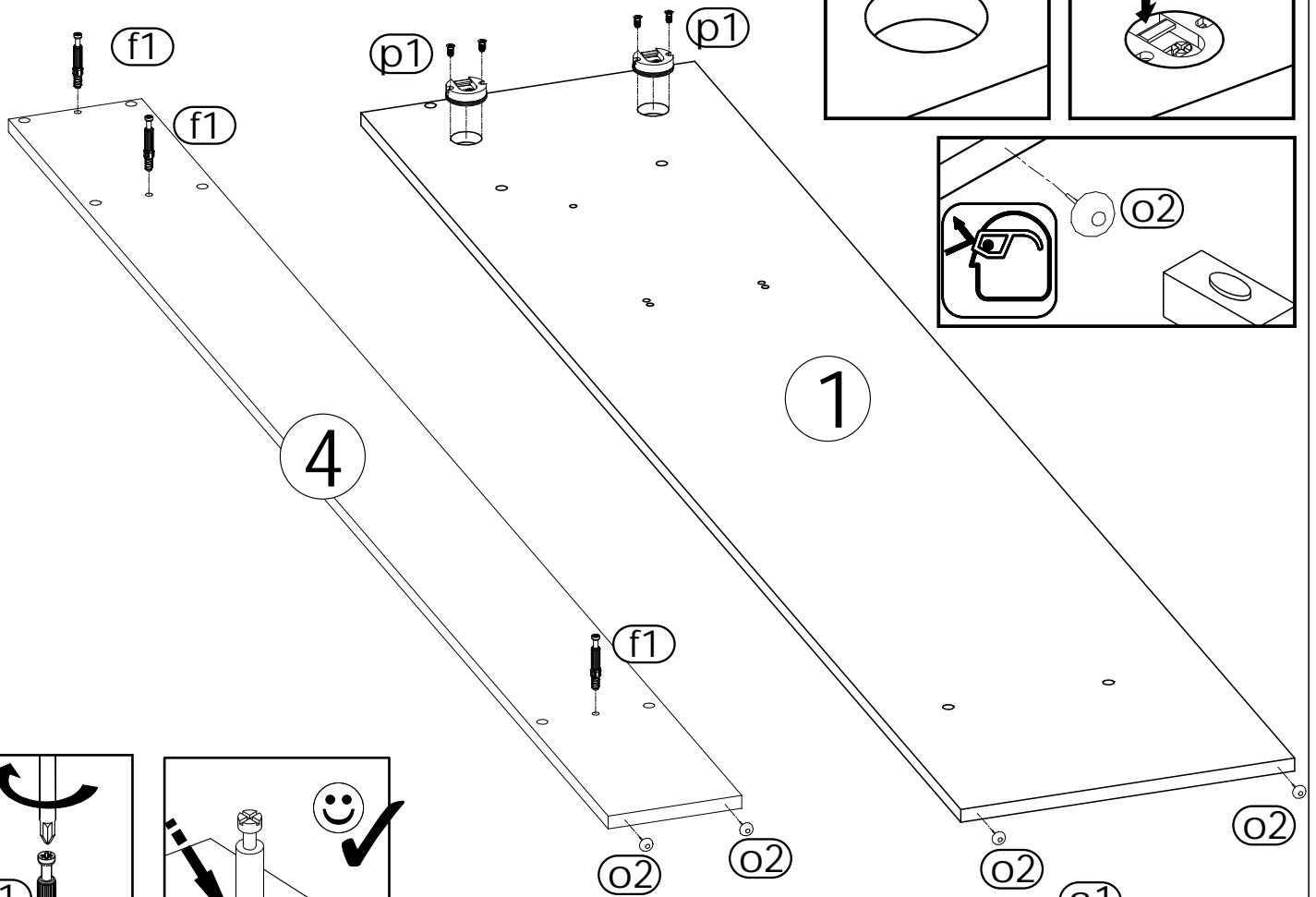
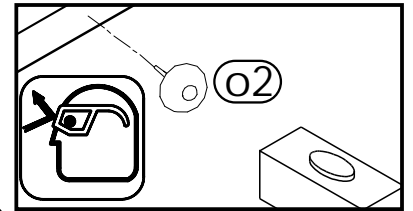
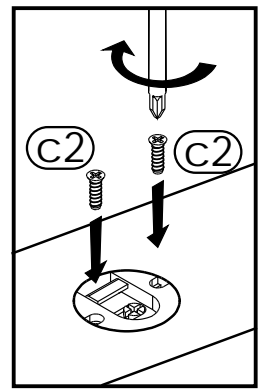
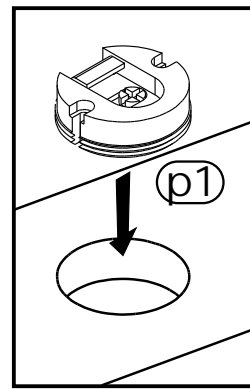
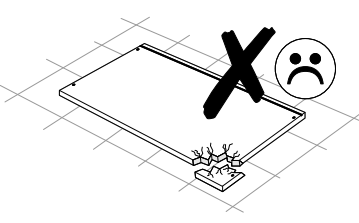
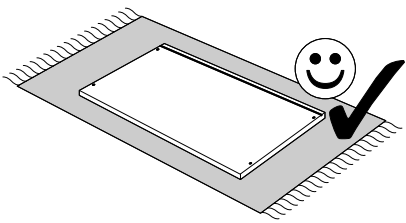

2

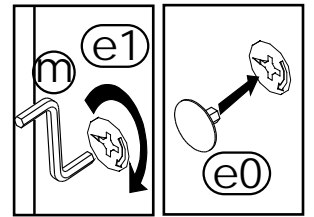
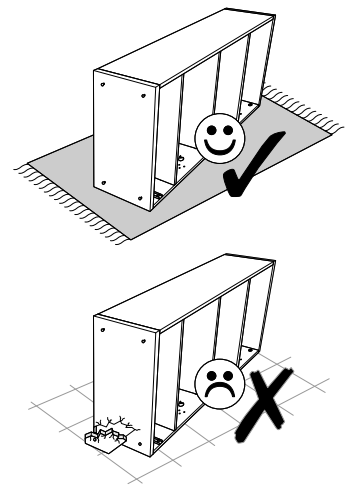
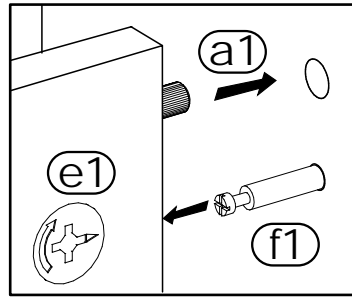
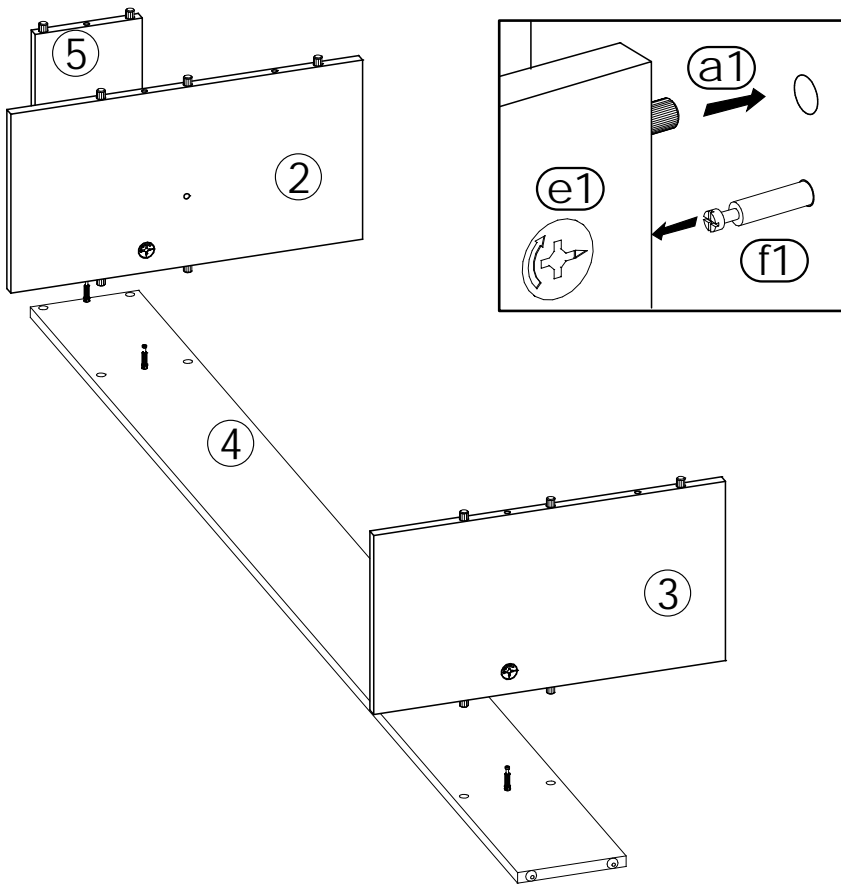

3

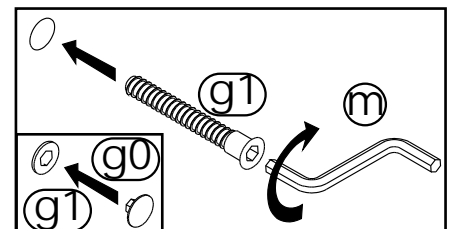
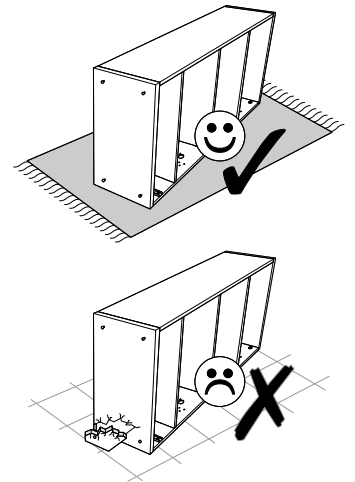
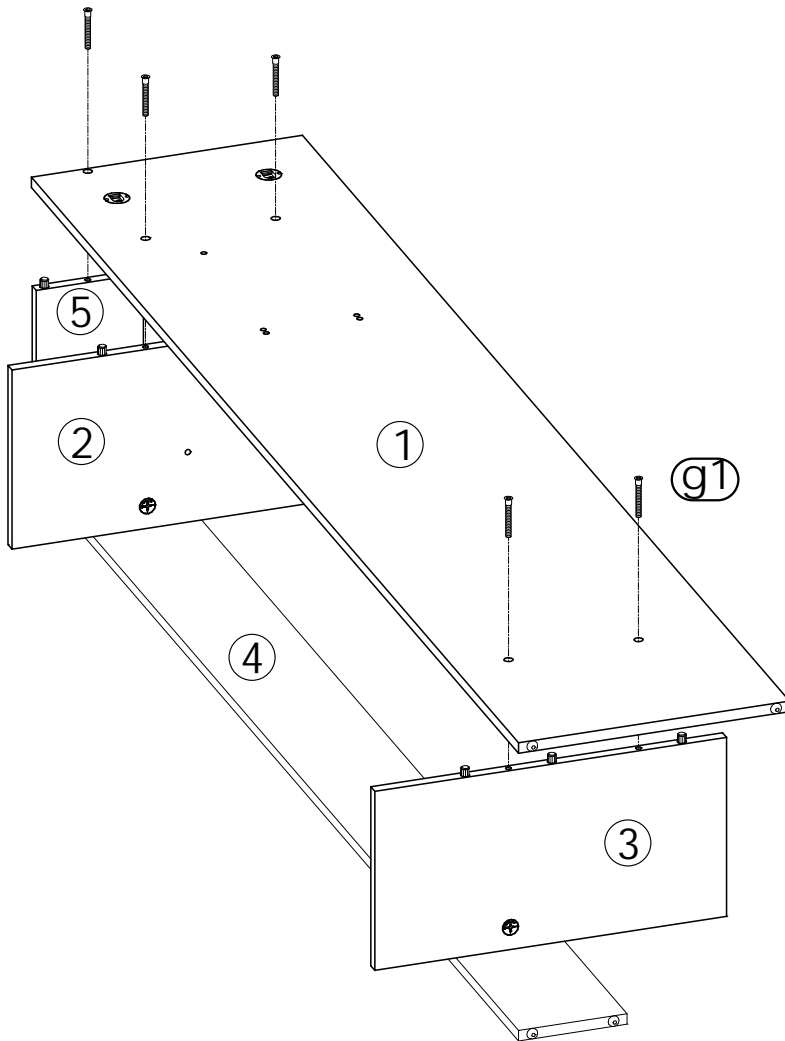

4

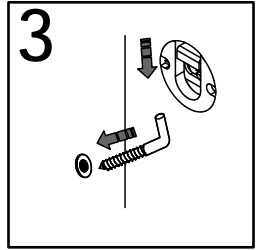
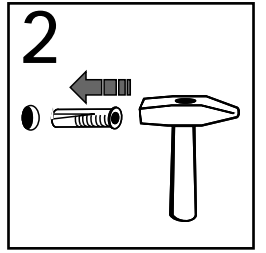
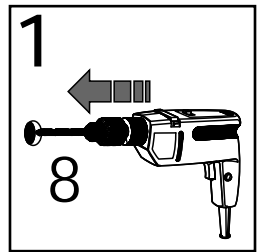
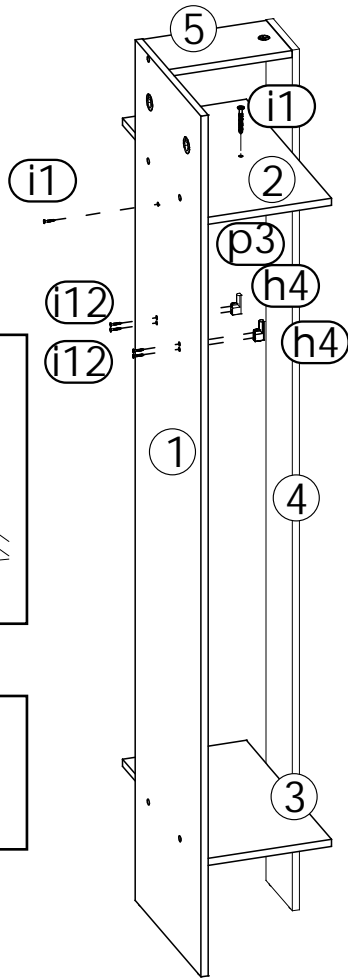
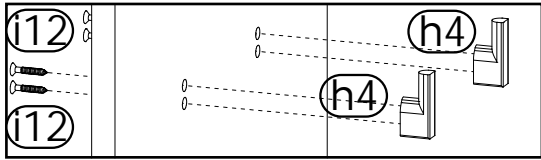
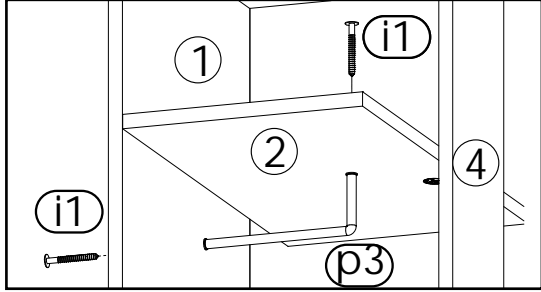
5